

LIBRARY
UNIVERSITY OF CALIFORNIA
DAVIS

C824
C2
A2
#109.
Prelim

UNIVERSITY OF CALIFORNIA
LIBRARY
FOR
COPY 2

THE RESOURCES AGENCY OF CALIFORNIA
Department of Water Resources

Bulletin No. 109

COLUSA BASIN INVESTIGATION

Preliminary Edition

JUNE 1962

UNIVERSITY OF CALIFORNIA
LIBRARY
JUN 2 1962
DIVERSITY

EDMUND G. BROWN
Governor
State of California

WILLIAM E. WARNE
Administrator
The Resources Agency of California
and Director
Department of Water Resources

State of California
THE RESOURCES AGENCY OF CALIFORNIA
Department of Water Resources

Bulletin No. 109

COLUSA BASIN
INVESTIGATION

Preliminary Edition

JUNE 1962

EDMUND G. BROWN
Governor
State of California

WILLIAM E. WARNE
Administrator
The Resources Agency of California
and Director
Department of Water Resources



The bottleneck of Colusa Basin drainage where the Knights Landing Ridge Cut meets the Yalo Bypass. Only two small channels (center foreground and at left adjoining road) are available for controlled release of drainage flows.

TABLE OF CONTENTS

	<u>Page</u>
LETTER OF TRANSMITTAL	x
ACKNOWLEDGEMENT	xi
ORGANIZATION, DEPARTMENT OF WATER RESOURCES	xii
ORGANIZATION, CALIFORNIA WATER COMMISSION	xiii
 CHAPTER I. INTRODUCTION	 1
Authorization for Investigation	1
Objective and Scope of the Investigation	3
Preliminary Reconnaissance	3
Extent of Problems Studied	4
Extent of Area Studied	4
Possible Solutions	5
Levee Protection	5
Flood Control Reservoirs	6
Watershed Management	6
Improved Drainage	7
Engineering and Economic Studies	7
Related Investigations and Reports	8
Organization of Report	9
 CHAPTER II. GEOGRAPHY AND ECONOMY	 11
Area of Investigation	11
Colusa Basin	12
Colusa Basin Drainage Area	13
Topography and Geology	14

	<u>Page</u>
Soils	15
Climate	17
Population	18
Reclamation	19
Sacramento River Flood Control Project	20
Works Constructed by Local Districts	22
River Levee	22
Back Levee	23
Knights Landing Ridge Cut	24
Colusa Basin Drainage Canal	24
Agricultural Development	29
Irrigation Works	29
Irrigation District Developments	30
Private Irrigation Development	33
Proposed Irrigation Development	33
Water Quality	34
Fish and Game	34
CHAPTER III. EXISTING AND POTENTIAL FLOOD AND DRAINAGE PROBLEMS	41
Existing Flood Problems	42
Existing Drainage Problems	42
Potential Flood and Drainage Problems	49
Construction of Major Works Outside the Project Area	49
Improvement of the Channels Tributary to the Drainage Canal	51
Changes in Land Use in Colusa Basin Drainage Area	52

	<u>Page</u>
Flood Analyses	53
Frequency and Degree of Flooding	53
Characteristics of Flood Hydrographs	55
Annual Distribution of Floods	56
Extent of Flooding	58
Flood Damages	58
Crop Damage	60
Miscellaneous Damage	63
CHAPTER IV. POSSIBLE SOLUTIONS	69
Colusa Basin Levee Projects	70
Estimated Costs	75
Project Benefits	75
Crop Damage Reductions	78
Miscellaneous Damage Reductions	80
Enhancement to Agricultural Lands	82
Enhancement to Urban Lands	82
Economic Justification	84
Foothill Reservoir Project	85
Watershed Management	90
Yolo Bypass Project	92
Check Structure (No. 1)	93
New Channel	93
Enlarged Tule Canal	94
Check Structure (No. 2)	98

	<u>Page</u>
Estimated Costs	98
Project Benefits	100
Economic Justification	103
 CHAPTER V. CONCLUSIONS AND RECOMMENDATIONS	 107
Conclusions	107
Recommendations	111

TABLES

<u>Table Number</u>		
1	Population Data and Projections	18
2	Principal Water Users in the Colusa Basin in 1959	31
3	Flows in Colusa Basin Drainage Canal at Highway 20 Bridge	45
4	Annual Distribution of Floods in Reaches 3, 4, and 5	57
5	Annual Distribution of Floods in Reaches 1 and 2	57
6	Estimated Crop Damage Resulting from Flooding in Reaches 1, 2, 3, 4, and 5	61
7	Present and Estimated Future Crop Pattern Without Additional Flood Protection in Reaches 1, 2, 3, 4, and 5	64
8	Flood Conditions and Present Flood Damage in Reaches 2, 3, 4, and 5	68
9	Channel Widths and Design Discharges for Colusa Basin Levee Projects	72

<u>Table Number</u>		<u>Page</u>
10	Estimated Capital Costs of Colusa Basin Levee Projects	76
11	Estimated Annual Costs of Colusa Basin Levee Projects	77
12	Estimated Annual Benefits of Colusa Basin Levee Projects	80
13	Comparison of Estimated Costs and Benefits of Colusa Basin Levee Projects	85
14	Summary of Foothill Reservoir Project	87
15	Probable Discharge in Willow Creek and the Colusa Basin Drainage Canal During a Once-In-50-Year Flood	88
16	Probable Flooded Areas in Reaches 2, 3, 4, 5, and 6 During a Once-In-50-Year Flood	88
17	Estimated Capital and Annual Costs of Yolo Bypass Project	99
18	Duration of Flooding in Reach 2	101

ILLUSTRATIONS

<u>Photograph Number</u>		
	Junction of Knights Landing Ridge Cut and Yolo Bypass	Frontispiece
1	Western Foothills of Colusa Basin Drainage Area	16
2	Knights Landing Outfall Gates	25
3	Colusa Basin Drainage Canal	27
4	Pumping Plant at Eldorado Bend	28
5	Irrigation Installation on Feeder Canal of Colusa Basin Drainage Canal	32
6	Ground Water Pumping Installation	32

<u>Photograph Number</u>		<u>Page</u>
7	Waterfowl in Colusa Basin	36
8	Typical Rice Field	44
9	Private Levee along Colusa Basin Drainage Canal	46
10	Knights Landing Ridge Cut at the Yolo Bypass	48
11	Flooding of Yolo Bypass from Knights Landing Ridge Cut	48
12	Tule Canal at Vicinity of Highway 20 Crossing	95
13	Tule Canal at Vicinity of Sacramento Bypass	96

FIGURES

<u>Figure Number</u>		
1	Generalized Geologic Section Across Colusa Basin Near Grimes	14
2	Pacific Migratory Waterfowl Flyway, Showing Principal Fall Migration Routes	37
3	Frequency of Flooding in Reaches 3, 4, and 5	54
4	Frequency of Flooding in Reaches 1 and 2	55
5	Probability of Flooding in Colusa Basin and Yolo Bypass	59
6	Probability of Crop Damages in Reaches 2, 3, 4, and 5	65
7	Probability of Miscellaneous Damages in Reaches 2, 3, 4, and 5	67

<u>Figure Number</u>		<u>Page</u>
8	Probability of Flooding in Colusa Basin With and Without the Colusa Basin Levee Projects	79
9	Probability of Crop Damages in Reaches 2, 3, 4, and 5 With and Without Colusa Basin Levee Projects	81
10	Probability of Miscellaneous Damages in Reaches 2, 3, 4, and 5 With and Without Colusa Basin Levee Projects	83
11	Probability of Flooding (April 1 through September 30) in Reach 1, the Northern Yolo Bypass, With and Without Yolo Bypass Project	102
12	Probability of Flooding in Reach 2, Knights Landing to College City, With and Without Yolo Bypass Project	102
13	Probability of Flood Damage With and Without Yolo Bypass Project	104

PLATES
(Plates are bound at end of report)

<u>Plate Number</u>	
1	Existing and Possible Flood Control and Drainage Features
2	Irrigated and Irrigable Lands, 1954-56
3	Principal Irrigation Water Service Agencies and Proposed Water Service Areas
4	Reclamation and Levee Districts
5	Profile and Typical Sections of Colusa Basin Levee Projects
6	Profile, Plan, and Typical Sections of Yolo Bypass Project

WILLIAM E. WARNE
Director of
Water Resources

EDMUND G. BROWN
GOVERNOR OF
CALIFORNIA

WILLIAM E. WARNE
ADMINISTRATOR
RESOURCES AGENCY

ADDRESS REPLY
P. O. Box 388
Sacramento 2,

B. ABBOTT GOLDBERG
Chief Deputy Director

REGINALD C. PRICE
Deputy Director Policy

NEELY GARDNER
Deputy Director
Administration

ALFRED R. GOLZÉ
Chief Engineer



THE RESOURCES AGENCY OF CALIFORNIA
DEPARTMENT OF WATER RESOURCES

1120 N STREET, SACRAMENTO

June 12, 1962

Honorable Edmund G. Brown, Governor, and
Members of the Legislature of the
State of California

Gentlemen:

I have the honor to transmit herewith the preliminary edition of Bulletin No. 109, "Colusa Basin Investigation." This bulletin summarizes the investigation authorized by the Legislature in 1959 by Senate Concurrent Resolution No. 79.

Bulletin No. 109 presents findings and conclusions as to the engineering feasibility and economic justification of providing improved drainage and additional flood protection for the Colusa Basin. The solutions investigated include plans for both localized and basin-wide improvements.

Sincerely yours,

Director

ACKNOWLEDGEMENT

During the course of this investigation, valuable assistance and data were contributed by many agencies. The Department of Water Resources gratefully acknowledges the cooperation of the following agencies:

Bureau of Reclamation, United States Department of
the Interior

Corps of Engineers, United States Department of the
Army

Soil Conservation Service, United States Department of
Agriculture

California Department of Fish and Game

California Reclamation Board

California Division of Highways

University of California at Berkeley and at Davis

The Counties of Colusa, Glenn, and Yolo

Glenn-Colusa Irrigation District

Reclamation District 1500

Laugenour & Meikle, Civil Engineers, Woodland,
California

Blackie & Wood, Civil Engineers, San Francisco,
California

Special mention is made of the helpful cooperation of the many private individuals who contributed damage data of great value in the evaluation of project benefits.

CALIFORNIA WATER COMMISSION

RALPH M. BRODY, Chairman, Fresno

WILLIAM H. JENNINGS, Vice Chairman, La Mesa

JOHN W. BRYANT, Riverside

JOHN P. BUNKER, Gustine

IRA J. CHRISMAN, Visalia

GEORGE C. FLEHARTY, Fresno

MARION R. WALKER, Ventura

JOHN J. KING, Petaluma

NORRIS POULSON, Los Angeles

-----O-----

WILLIAM M. CARAH
Executive Secretary

GEORGE B. GLEASON
Principal Engineer

CHAPTER I. INTRODUCTION

The Colusa Basin is a leading agricultural area as well as one of the most notable waterfowl hunting areas in the State. It is located in the Sacramento Valley along the west side of the Sacramento River and extends from Stony Creek on the north to Cache Creek on the south. In the early part of its history, the Colusa Basin produced mainly dry-farmed grain. The area has been progressively developed for irrigated agriculture and is presently a major producer of rice. Several reclamation districts have been formed. An extensive system of levees has been constructed along the Sacramento River and along the various drainage channels to protect the basin from inundation by floods of the Sacramento River each winter. The levees, however, have not solved local problems of shallow flooding of large areas of the basin. During the winter months, runoff from tributary drainage areas backs up behind the levees and along inadequate drainage channels. Such flooding damages fall planted crops. During the late spring months, similar problems of flooding result from return flow from irrigation practices.

Authorization for Investigation

Interested individuals on several occasions have met with representatives of the Department of Water Resources to discuss the current drainage and flood problems in the Colusa Basin. The Legislature became interested in the problems and, in 1959, passed Senate Concurrent Resolution No. 79 requesting the department to make a study of the problems of flooding and drainage in the Colusa Basin. This resolution reads as follows:

SENATE CONCURRENT RESOLUTION NO. 79--RELATING TO A STUDY OF
THE "COLUSA BASIN."

"WHEREAS, There exists in the Counties of Glenn, Colusa, and Yolo inadequate drainage and flood control facilities that are necessary for the general area located therein which is known as the 'Colusa Basin'; and

"WHEREAS, This condition of inadequate drainage and flood control has annually resulted in great damage to the agricultural crops in the area amounting to many thousands of dollars each year; and

"WHEREAS, The agricultural and economic development of the area is greatly impeded by these conditions; and

"WHEREAS, The creation of new irrigation and soil conservation districts in this area will compound the damages now being suffered; and

"WHEREAS, It is necessary for an overall plan to be developed for this area to alleviate the damages caused by drainage, seepage and storm water disposal, giving due consideration to the established water rights existing in the area; now, therefore, be it

"Resolved by the Senate of the State of California, the Assembly thereof concurring, That the Department of Water Resources is hereby requested to make a comprehensive study of the 'Colusa Basin' for the purpose of determining the best manner for alleviating the problems resulting from inadequate drainage and flood control facilities, seepage and storm water disposal giving due consideration to the protection of established water rights in the area; and be it further

"Resolved, that the Secretary of the Senate is directed to transmit a copy of this resolution to the Department of Water Resources."

To support the study directed by SCR No. 79, the Legislature added \$80,000 to the Department of Water Resources 1959-60 Budget (Item 262.5) to be spent during the 1959-60 and 1960-61 fiscal years.

Objective and Scope of the Investigation

The general objective of the Colusa Basin Drainage Investigation was to develop the information requested in Senate Concurrent Resolution No. 79. This objective was achieved by conducting engineering and economic studies directed toward the formulation of a plan for alleviating the drainage and flooding problems in the Colusa Basin.

Preliminary Reconnaissance

In order to comply with the legislative directive "... to make a comprehensive study of the 'Colusa Basin' for the purpose of determining the best manner for alleviating the problems resulting from inadequate drainage and flood control facilities, seepage and storm water disposal, giving due consideration to the protection of established water rights in the area", the first step by the Department of Water Resources was to make a rapid reconnaissance survey of the problems of the area. Information was assembled pertaining to the geography of the basin, existing flood control and drainage works, the hydrology of flooding, and, most important, the identification of areas subject to flood damages. This latter information came from interviews with residents and landowners.

The reconnaissance survey indicated that the Colusa Basin appears to be adequately protected from floods of the Sacramento River, which, in the past, were the major threats. To some extent, floods originating from local runoff have been controlled, although the areas not presently protected by levees continue to suffer frequent damage from floods of a local nature. Inadequate drainage of irrigation return flows at certain periods of the year causes damage to crops planted earlier in the year.

The areas presently subject to such flooding are located along Willow Creek and along a 50-mile reach of the Colusa Basin Drainage Canal. The maximum areas flooded in recent years, as indicated on Plate 1, "Existing and Possible Flood Control and Drainage Features", include approximately 100,000 acres. The preliminary survey indicated that inadequate drainage of irrigation return flows during summer months is the most serious problem in the southern reaches, while winter flooding is the most serious problem in the northern reaches.

Extent of Problems Studied

The scope of studies conducted during the subsequent two-year investigation was limited to seeking solutions for existing drainage and flood control problems with consideration of the effect of probable future development. Primary consideration was given to engineering improvements to the master drainage facilities. The problems on tributary channels and of farm drainage were considered only in their relationship to the major facilities. Consideration of individual farm drainage was not within the scope of this investigation.

A reconnaissance level study was made of fish and wildlife in the area of Colusa Basin subject to flooding. Particular attention was given to migratory waterfowl, because the waterfowl habitat is dependent upon natural flooding. A more intensive study than was made would be required to determine the effects that construction of levees and flood control works in the Colusa Basin would have on waterfowl.

Extent of Area Studied

The area to which studies within the Colusa Basin were confined was determined during the initial reconnaissance. At that time the U. S. Corps of Engineers was engaged in study of flood control on the upper reaches

of Willow Creek and its tributaries. Although a small project was found economically justified in that area, public hearings indicated that local interests were unwilling to assume the operation and maintenance requirements necessary to obtain state and federal financial participation. On December 23, 1960, the Corps of Engineers reclassified this project to an inactive status. Accordingly, no works were considered for the area affected by the Corps of Engineers' study. Within the main body of the Colusa Basin, studies were confined to the area flooded in recent years. At the southern extremity of the Colusa Basin Drainage Canal, drainage problems associated with the canal extend into the Yolo Bypass. Therefore, the study area was extended south in the Yolo Bypass to the Sacramento Deep Water Ship Channel.

Possible Solutions

To comply with the objectives of the investigation, several alternative solutions to the existing problems of flooding and inadequate drainage were considered. These were: (1) systems of levees to protect areas subject to damage; (2) flood control reservoirs in the western foothills; (3) watershed management to reduce runoff rates; and (4) improvement and enlargement of existing drainage facilities. These approaches to a satisfactory solution are discussed in the following paragraphs with an indication of the results that may be expected for each alternative and the emphasis placed on analysis of each possible solution.

Levee Protection. Levee projects of several sizes providing substantial flood control protection to the presently flooded areas of the Colusa Basin were thoroughly investigated and found to be physically feasible. All engineering and economic factors needed to determine the economic justification of these projects were analyzed. A major portion of the work involved in this investigation was directed toward this phase.

The largest levee system studied would provide protection from floods reaching the magnitude of that expected to occur once-in-50-years. Evaluation of the benefits provided by this project showed an extremely unfavorable benefit-cost ratio. Annual costs would exceed annual benefits by approximately 3 to 1. Consideration was given to providing a lesser amount of protection by reducing the size of the levee system. If protection from floods expected to occur once-in-ten-years was provided, costs would exceed benefits by approximately 2 to 1. For the present level of development in the Colusa Basin, therefore, a levee project would not be economically justified.

Flood Control Reservoirs. About 80 percent of a flood entering the Colusa Basin is contributed by 17 streams draining the foothills to the west. The cost of constructing flood control reservoirs on these streams was estimated and found to exceed that of a levee system. Furthermore, the reservoirs could provide a reduction only of about 50 percent in the area flooded as compared to the once-in-50-year levee protection project discussed above. Any flood control reservoir project, therefore, would require a supplemental levee system and be more costly than a levee system alone. Designs and cost estimates were prepared at a reconnaissance engineering level, and the results did not indicate that more detailed work would be warranted.

Watershed Management. A brief investigation was made into the feasibility of limiting flood flows by improved watershed management. With proper watershed treatment, some reduction in flood flows could be expected; but it is considered highly improbable that, by watershed protection measures, adequate control of flood waters could be realized. The investigation of watershed management was quite limited in scope and, because of

the complexities involved, would require an extensive analysis to evaluate fully its potential.

Improved Drainage. The construction of improved drainage facilities from the mouth of the Knights Landing Ridge Cut through the Yolo Bypass was found to provide a limited degree of protection to lands at the southerly end of the Colusa Basin and within the upper portion of the Yolo Bypass. This project, designated the Yolo Bypass Project, would provide benefits approximately 34 percent greater than its cost. Although the drainage project is economically justifiable, it provides only a very limited amount of protection to the lands presently damaged by flood flows in the Colusa Basin.

Engineering and Economic Studies

Studies to analyze properly the engineering feasibility and economic justification of the above-stated alternatives, particularly the levee and drainage projects, may be grouped into four general categories; hydrology, hydraulics; economics, and design.

Hydrology studies included estimates of the magnitude of floods and probable frequency of flooding with existing drainage channel facilities under present and future conditions of land use. The development of these relationships was based on a combination of regional hydrologic studies and streamflow records in the area.

Hydraulic studies consisted of analyses of the effects that the various proposed projects would have on flows of various magnitudes. The results of these studies were used primarily in the design of projects for the control of the various sized floods investigated. The hydraulic capacity of existing channels was determined from rating curves for stream gaging stations or by field survey methods.

Economic studies were made to determine the benefits which would accrue to the various projects considered. Since the benefits would consist primarily of damages prevented, extensive field work was done in estimating the types and amounts of historical damages. In determining these benefits, a land use study was made for existing and projected future land use within the historically flooded areas.

Design studies were limited to preliminary designs and estimates of cost. While these designs are not of the detail required for actual construction, they are of sufficient accuracy to provide a measure of project feasibility by comparing estimated costs with benefits. After the economic justification of the Yolo Bypass Project was determined, a detailed review of design and cost estimating criteria was made. The costs reported for the Yolo Bypass Project reasonably represent 1961 construction costs, and are adequate for the purposes of this investigation.

Related Investigations and Reports

A review of related investigations and reports, both published and unpublished, has provided much of the background and data needed to conduct this investigation. A great deal of information relative to the history and reclamation of the Colusa Basin was obtained from files of the Reclamation Board of the State of California. Basic data concerning stream flow and floods were obtained from publications of the U. S. Geological Survey, the U. S. Corps of Engineers, the U. S. Bureau of Reclamation, and the State of California Department of Water Resources.

The U. S. Corps of Engineers has made numerous studies in connection with the Sacramento River Flood Control Project. Although no specific report pertaining to the Colusa Basin has been published, several reports have included information useful in evaluating the flood and drainage problems of the Colusa Basin.

The U. S. Bureau of Reclamation, in connection with its responsibilities for the Central Valley Project, has also published information useful in evaluating the problems of the Colusa Basin. Investigations and reports in connection with the Sacramento Canals Unit, Sacramento Valley Project, were particularly helpful in estimating future flows in the Colusa Basin.

Organization of Report

The report on the Colusa Basin Investigation is presented in the ensuing chapters. Chapter II discusses the "Geography and Economy" of the Colusa Basin and is intended to acquaint the reader with the physical features of the basin, the flood control and irrigation works developed during its history, and the economic development that is affected by its flood and drainage problems.

Chapter III, "Existing and Potential Flood and Drainage Problems," presents information relating to present and future flood and drainage problems with the hydrologic analysis needed to design corrective works. Flood damages that presently occur, and that would occur in the future without project development, are also presented.

"Possible Solutions" are discussed and analyzed in Chapter IV. Chapter V is a summary of conclusions and recommendations.

In addition to the illustrations and figures included in the bulletin, six plates are bound following the text. Of particular interest is Plate 1, "Existing and Possible Flood Control and Drainage Features," showing the area of investigation, historically flooded areas, and the locations of possible improvements.

CHAPTER II. GEOGRAPHY AND ECONOMY

The Colusa Basin is a shallow trough lower in elevation than the Sacramento River that borders it on the east. In its natural state, the basin was subjected to overflow from the Sacramento River whenever the capacity of the river channel was exceeded during winter floods and spring snowmelt floods. Annual flooding was common. Precipitation within the area, as well as runoff from the western foothills, added to the flooding.

The present agricultural development of the Colusa Basin has been made possible by the flood control and reclamation features constructed by the individual and cooperative efforts of local, state, and federal agencies. Many of the flood control works protecting the basin from floods have been constructed as part of the extensive Sacramento River Flood Control Project.

Agricultural activities are the most significant factor in the area's economy. Considerable recreational activity also takes place in the form of hunting for ducks, geese, and pheasants. Waterfowl are attracted to the Colusa Basin in their seasonal migrations by the presence of extensive flooded areas.

Area of Investigation

The Colusa Basin is one of several similar basins that are located in the Sacramento Valley. The several basins adjoin the Sacramento River and are separated by the major tributaries of the Sacramento River System. The Sacramento River collects runoff from the entire Sacramento Valley and conveys this water to Suisun Bay.

The basins generally can be described as depressed areas or shallow troughs located on each side of the Sacramento River. The Sacramento River flows on an elevated ridge that has been built from the silt and sand carried by the river during times of flood. The basins were formed by the gradual

building up of the banks of the river from sediments deposited as the water overflowed its natural channel. The heavier and larger sediments carried by these flood flows were deposited on the banks and near the main channel while the finer, smaller particles were carried considerably further from the main channel. The slope of the ground away from the main channel is relatively steep and gradually flattens towards the center portions of the basins, which are generally 6 to 20 feet lower than the river banks.

During seasons of heavy rainfall, and before the present system of levees in the Sacramento Valley was constructed, the flood basins or troughs were filled by runoff from the adjacent plains and hills, and by water from the main river flowing over the banks. The basins usually discharged through sloughs, either back into the main channel, or into the next lower flood basin. In times of great prolonged floods, these basins performed a dual function, acting both as large shallow flood water channels and as temporary storage or equalizing reservoirs that reduced the peak of the floods. The basins would remain full of water until the river receded to a stage that would allow the basins to drain.

Colusa Basin

The Colusa Basin is one of two major basins lying west of the Sacramento River. The Yolo Basin, located southerly of the Colusa Basin, is separated from the Colusa Basin by the Knights Landing Ridge. This ridge was formed by sediments from Cache Creek deposited in a manner similar to those deposited by the Sacramento River. The Colusa Basin extends over portions of the counties of Glenn, Colusa, and Yolo. The exact limits of the Colusa Basin are not precisely defined, but generally include those lower lands that may be covered by flood water. The Colusa Basin has an overall length of approximately 70 miles and a maximum width of about eight miles. It is divided into an upper

and lower basin by a small ridge created by the sedimentary deposits from Upper Sycamore Slough. The upper basin is a comparatively narrow tract of land, generally not more than four miles in width.

Colusa Basin Drainage Area

The drainage area of the Colusa Basin extends from the Sacramento River on the east to the crest of the foothills on the west. Stony Creek and Cache Creek are the approximate northerly and southerly boundaries, respectively. The Colusa Basin drainage area, identified on Plate 1, includes about 1700 square miles. Plate 2, "Irrigated and Irrigable Lands, 1954-56" shows the location of the agricultural lands within this area. Water agencies serving the area are shown on Plate 3, "Principal Irrigation Water Service Agencies and Proposed Water Service Areas." The physical works of the water agencies and the various reclamation and levee districts located within the area are important factors in the agricultural economy of the Colusa Basin. The various reclamation and levee districts are shown on Plate 4, "Reclamation and Levee Districts."

Topography and Geology

Figure 1, a generalized east-west geologic section across the Colusa Basin near Grimes, depicts the topography of the Colusa Basin drainage area. The geologic classification of the subsurface materials also is indicated in this figure. The foothills and uplands which are shown in about the western one-third of the figure are part of the Coast Range. The remainder of the figure shows the relatively flat floor of the Sacramento Valley.

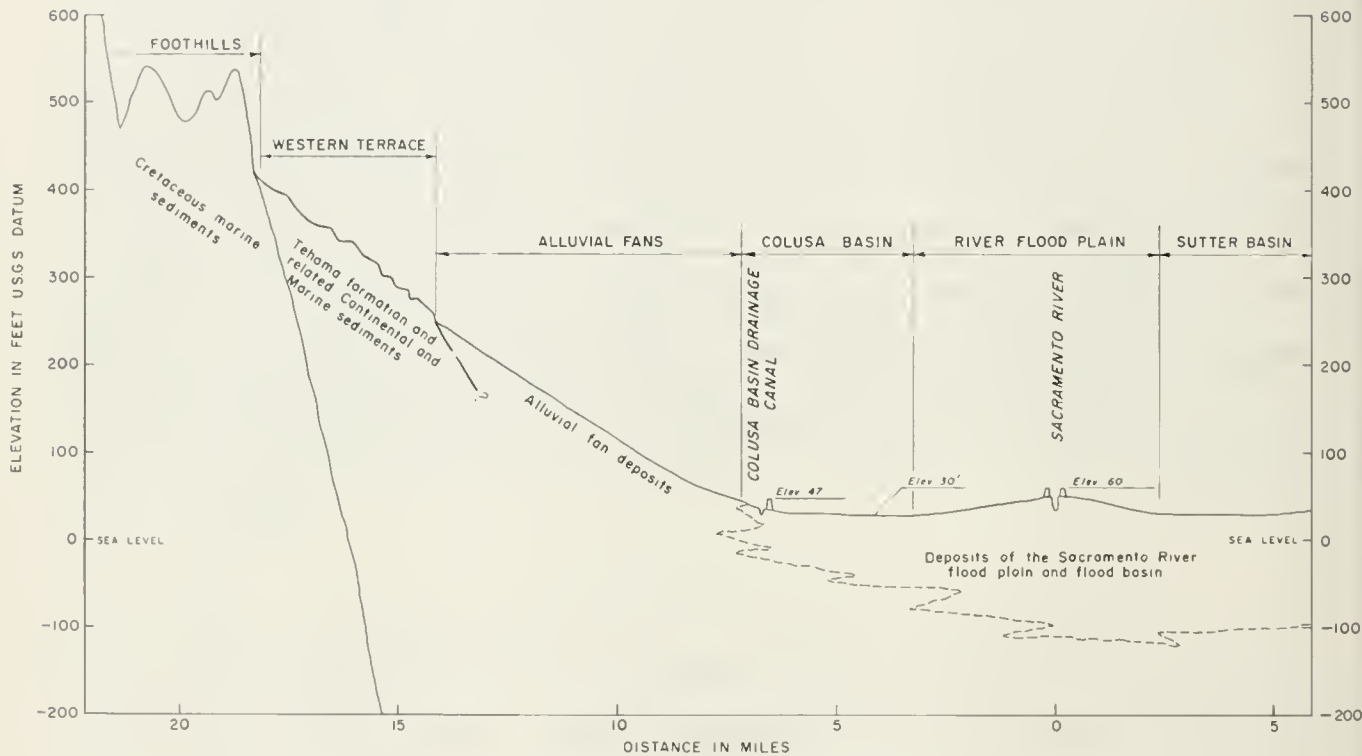

Figure 1. GENERALIZED GEOLOGIC SECTION
ACROSS COLUSA BASIN NEAR GRIMES

The hills and mountains of the Coast Range are composed mainly of sedimentary sandstones, shales, and conglomerates. These hills, in the western portion of the Colusa Basin drainage area, resemble a giant deck of cards stacked nearly on edge. The more resistant strata stand out as ridges, while the intervening, less resistant have been worn down by erosion.

This is illustrated by the photograph on page 16. The sedimentary strata dip beneath the valley, lie thousands of feet beneath the central part of the valley, and emerge on the other side in the foothills of the Sierra Nevada. The valley floor was formed primarily by the deposition of material carried by flood waters of streams. Geologically, the principal formations of the valley are the alluvial fan deposits, the flood basin deposits, and the river deposits. The alluvial fan deposits were laid down by streams draining the Coast Ranges and vary in composition from clay to gravel. Deposits of the Sacramento River include channel deposits, natural levees, flood plains, and flood basins. All but the flood basin deposits were laid down by active waters and are primarily coarse grained. The flood basin deposits, which make up a major portion of Colusa Basin proper, are mostly composed of fine-grained material deposited by slowly moving or standing water.

Soils

Soils in the Colusa Basin vary in their chemical and physical characteristics in accordance with differences in their parent material, drainage, and age or degree of development since their deposition. The soil characteristics exercise a strong influence on the relationship between precipitation and runoff. The principal influence of the coarse-textured soil in the western foothill area is that runoff results only after very heavy, sustained storms. The soils of the valley floor are finer-textured and much less pervious; consequently, a higher percentage of the precipitation tends to run off. However, the valley lands are relatively flat and runoff is slow.

Most of the fine-textured valley floor soils having slow to very slow permeability rates were derived from slow moving flood water.



The more resistant strata stand out as ridges, while the intervening, less resistant have been removed by erosion.

A large part of these clayey soils are affected to varying degrees by concentrations of soluble salts or exchangeable sodium. Those affected by soluble salts are called saline soils, and those with an excess of exchangeable sodium are known as alkali soils. Both of these conditions have occurred primarily as the result of poor drainage, a slow permeability rate, a high ground water level, and a high rate of evaporation during the summer. Alkaline soils resulting primarily from sodium sulphate (glaubers salt) occur in most of the basin.

The crop adaptability of these fine-textured, salt-affected soils is greatly restricted at the present time. The improvement of drainage conditions would assist markedly in bringing about their reclamation. Dispersed throughout the area are relatively small bodies of coarse-textured soils which were derived from depositions of fast-moving flood waters and lie adjacent to stream channels. These soils have good permeability, are free of soluble salts or exchangeable sodium, and are suitable for a wide range of climatically adapted crops.

Climate

The climate of the Colusa Basin is characterized by dry summers with high daytime temperatures and warm nights, and wet winters with moderate temperatures. More than 80 percent of the precipitation occurs during the five-month period from November through March. The growing season between killing frosts is long; the average for Colusa, located centrally in the area, is about 288 days. The average for Willows is 224 days. Temperatures at Colusa have ranged from 14^oF. to 114^oF. for the 47 years of record; the monthly average ranges from 45^oF. in January to 78^oF. in July. Temperatures at Willows have ranged from 15^oF. to 116^oF., and the monthly average ranges from 45^oF. in January to 80^oF. in July.

Population

The Colusa Basin has had a gradual increase in population as indicated by census figures from 1920 to 1960. Table 1 shows this trend by counties as well as projected increases over the next 60 years. Population figures for the northern part of Yolo County, Knights Landing Division, located in the Colusa Basin, indicate an increase more similar to that experienced in Colusa County than that in the remainder of Yolo County. Future population increases in the Colusa Basin drainage area are expected to follow the trend predicted for Colusa and Glenn Counties.

TABLE 1
POPULATION DATA AND PROJECTIONS^{1/}
(In thousands)

Years	:	Colusa	:	Glenn	:	Yolo	:	Yolo County Knights Landing Division ^{2/}
1920	:	9.3	:	11.9	:	17.1	:	---
1930	:	10.3	:	10.9	:	23.6	:	2.8
1940	:	9.8	:	12.2	:	27.2	:	3.1
1950	:	11.7	:	15.4	:	40.6	:	3.2
1960	:	12.1	:	17.2	:	65.7	:	3.0
1970	:	13.8	:	22.6	:	91.8	:	---
1980	:	17.4	:	30.0	:	136.0	:	---
1990	:	27.0	:	42.8	:	209.0	:	---
2000	:	43.7	:	60.3	:	319.0	:	---
2010	:	64.5	:	80.5	:	453.0	:	---
2020	:	89.0	:	104.0	:	614.0	:	---

^{1/} Projections of population are Department of Water Resources estimates as of September 1960.

^{2/} The Knights Landing Division is defined by the U. S. Bureau of the Census in the 1960 census. For other years, the sum of the populations of the Blacks, Cacheville, Dunnigan, and Grafton Townships are used.

Reclamation

The development of Colusa Basin into a productive agricultural area has been dependent upon the progressive reclamation of the area to prevent flooding, improve drainage, and provide irrigation. Individuals, local districts, state and federal agencies, through the years have constructed various works necessary to the farming of the fertile acres located within the basin. Local reclamation districts were the first agencies to develop the area for agricultural purposes. Investigations and proposals by the state and federal government, in the early 1900's, concerning flood protection in the Sacramento Valley greatly influenced the subsequent developments within the Colusa Basin.

In 1850, through the passage by Congress of the Arkansas Act, the State of California obtained from the federal government approximately one and three-quarter million acres of swamp and overflow lands. In accepting these lands, the State was obligated to reclaim them as far as practicable. Laws in 1855, 1856, and 1859 provided for sale of these lands to the public at a price of \$1.00 an acre in tracts not to exceed 640 acres, with the condition that the purchaser should reclaim portions of the land. A more definite system of reclamation of swamp and overflow lands was established in 1861 when the State assumed direct responsibility for reclamation. In doing so, it established a board of Swamp Land Commissioners to plan, authorize, and supervise reclamation works; and it empowered districts to levy assessments to raise funds for reclamation projects. These duties and responsibilities underwent numerous changes until the reclamation districts as presently constituted were established.

Reclamation districts have been effective agencies to accomplish initial reclamation, not only in the Colusa Basin but also in extensive areas of the Delta, and Sacramento and San Joaquin Valleys. Their

activities hastened agricultural development in California. However, reclamation was accomplished bit by bit, without coordinated planning; and improvements in one area often would worsen flood hazards in another area.

The Sacramento River Flood Control Project, a joint venture of local, state, and federal agencies, received federal sanction in 1917. Because initial reclamations by local districts have been modified subsequently to conform to the general plans developed for the Sacramento River Flood Control Project, a brief discussion of that project will be presented first. The description of works constructed by local districts, which in some instances were initiated prior to the conception of the Sacramento River Flood Control Project, will follow the discussion of that project.

Sacramento River Flood Control Project

The Legislature of the State of California, on December 24, 1911, approved the California Debris Commission plan for controlling floods of the Sacramento River and created the State Reclamation Board to supervise the carrying out of this project. The Sacramento and San Joaquin Drainage District, which included practically all of the overflow land in the valleys of Sacramento and San Joaquin and which comprised some 1,750,000 acres, was organized in 1913. The Reclamation Board was charged with its supervision.

The Sacramento River Flood Control Project, as adopted by the State of California in 1911, was authorized also as a federal flood control project in 1917. Although subsequent modifications to the basic plan have been authorized by both the state and federal governments, the original concepts proposed by the California Debris Commission have been substantially followed. The bypass concept was adopted after the floods of 1907 and 1909 demonstrated the insufficiency of the proposals to confine flood flows to the main river channels. The bypass concept is based on the diversion of

flood flows from the main channel to an auxiliary channel or bypass. The concentration of flooding in the winter months has made it possible to utilize the bypass areas for agricultural pursuits during the remainder of the year in all but those years when flood flows persist beyond the planting period for crops.

The project, now substantially completed, consists of a comprehensive system of levees, overflow weirs, drainage pumping plants, and flood bypass channels. The bulk of the flood flows passing through the Sacramento Valley is conveyed by weirs from the Sacramento River to the Sutter Bypass and Yolo Bypass. Flood waters then continue downstream and return to the Sacramento River in the vicinity of Rio Vista. The original proposal to construct a bypass in Butte Basin has never been implemented. Floods continue to discharge by over-bank flow into Butte Basin which acts as a natural detention basin reducing inflow to the upper end of the Sutter Bypass.

Work on the Sacramento River Flood Control Project within the Colusa Basin has been done by the state and federal governments as recently as 1958. This work resulted in the improvement of the back levee of Reclamation District No. 108 from Knights Landing to high ground in the vicinity of Colusa.

In early years, proposals were made for a bypass through the Colusa Basin, generally along the alignment of the Colusa Basin Drainage Canal. This bypass would have carried Sacramento River flows safely through the Colusa Basin area, as well as collecting and providing drainage for local runoff occurring within the Basin. The construction of the Sutter Bypass, on the east side of the river, as part of the Sacramento River Flood Control Project to carry Sacramento River flood flows eliminated the need

for a similar bypass in the Colusa Basin. Consequently, desirable drainage features which would have been included with the proposed Colusa Basin bypass were not constructed.

Works Constructed by Local Districts

The levee system and reclamation works within the Colusa Basin in many instances have been constructed by the reclamation districts, the locations of which are shown on Plate 4. Construction activity by these districts started in 1868. In the discussion which follows only the more significant activities as related to the key flood control and drainage features will be discussed. The activities of the several districts involved are discussed in regard to the major reclamation features including the river levee, the back levee, the Knights Landing Ridge Cut, and the Colusa Basin Drainage Canal.

River Levee. Flooding from the Sacramento River was the initial concern of Reclamation District No. 108, and its early activities were devoted to providing a levee system which would prevent this flooding. The district eventually constructed and maintained a levee on the right, or west, bank of the Sacramento River between Knights Landing and the town of Sycamore in Colusa County. The total length of this levee system was about 39 miles. The district also was interested actively in the extension of this levee upstream about 40 miles more. It contributed the greater portion of the funds required to construct the upper portion. Throughout early years, construction work was continued, maintenance was performed, and weaker sections of the levee were strengthened. In 1915 the Sacramento River West Side Levee District assumed the maintenance of the river levee upstream from Eldorado Bend. Reclamation District No. 787, formed in 1908, assumed the maintenance of the lower nine miles of river levees extending southerly from Eldorado Bend to Knights Landing.

The construction of this river levee blocked the natural drainage outlets from the Colusa Basin. Each spring the accumulated drainage would be released back to the river by the cutting of the levee at Knights Landing. This necessitated the reconstruction of the levee before the next winter's river floods. As early as 1883, a structure with automatic gates was provided to allow for drainage from the basin. This solution, however, was not effective because it was generally late in the planting and growing season before the accumulated drainage waters could be released. To permit releases while high stages prevailed in the Sacramento River, a drainage pumping plant at lower Sycamore Slough was constructed in 1885.

Back Levee. The back levee of Reclamation District No. 108 has been improved and strengthened progressively to conform fully with requirements of the Sacramento River Flood Control Project. Its present alignment easterly of the Colusa Basin Drainage Canal is shown on Plate 1. The back levee extending from Knights Landing to high ground near Colusa protects lands to the east from flood runoff of the western foothills. In early years, considerable difficulty was encountered in maintaining portions of this levee. Limited funds were available and, consequently, levee sections were not nearly as massive as they are at present. In flood periods, an extensive lake would form west of the back levee; then wind-caused waves would wash away the levee sections. In early years, breaks were frequent. In some years ponding became so extensive that flood waters would overtop the levee and flood the reclaimed area, and would also overflow the Knights Landing Ridge to flood lands in the Yolo Basin. Drainage through the Knights Landing outfall gates was impossible because of high water in the Sacramento River. Not until 1958 was the back levee brought to full standards of the Sacramento River Flood Control Project.

Knights Landing Ridge Cut. In 1913, the Knights Landing Ridge Drainage District was formed to develop a plan to provide an outlet for water ponded between the back levee and high ground on the west and south. Drainage of this water would be further restricted from flowing through the Knights Landing outfall gates by high stages in the Sacramento River. The district proposed a cut through the high ground on the south to provide an outlet for the ponded water.

The Knights Landing Ridge Cut subsequently was dredged through the Knights Landing Ridge for a distance of about seven miles. This cut terminated in low lying land in the Yolo Basin at the western edge of what is now known as the Yolo Bypass. The cut is about 400 feet wide on the bottom and has a maximum depth of nearly 20 feet. It has a discharge capacity of about 20,000 second-feet when the water surface elevations (USED datum) are 39 feet at Knights Landing and 35 feet at the Yolo Bypass. The ridge cut was completed and in operation during the flood of September 1915.

The Knights Landing Ridge Cut provides a gravity outlet for floods occurring in the Colusa Basin. The outlet does not prevent the flooding of extensive areas along the Colusa Basin Drainage Canal during flood periods, but it greatly reduces the length of inundation.

Colusa Basin Drainage Canal. As development of the irrigated lands in the Colusa Basin continued, return flows from irrigation during certain periods of the year created flooding problems downstream from the areas irrigated. Because of the inadequacy of the drainage facilities within the Colusa Basin, Reclamation District No. 2047 was formed on December 16, 1919. This district developed a plan and constructed physical works designed to handle the anticipated irrigation return flow.

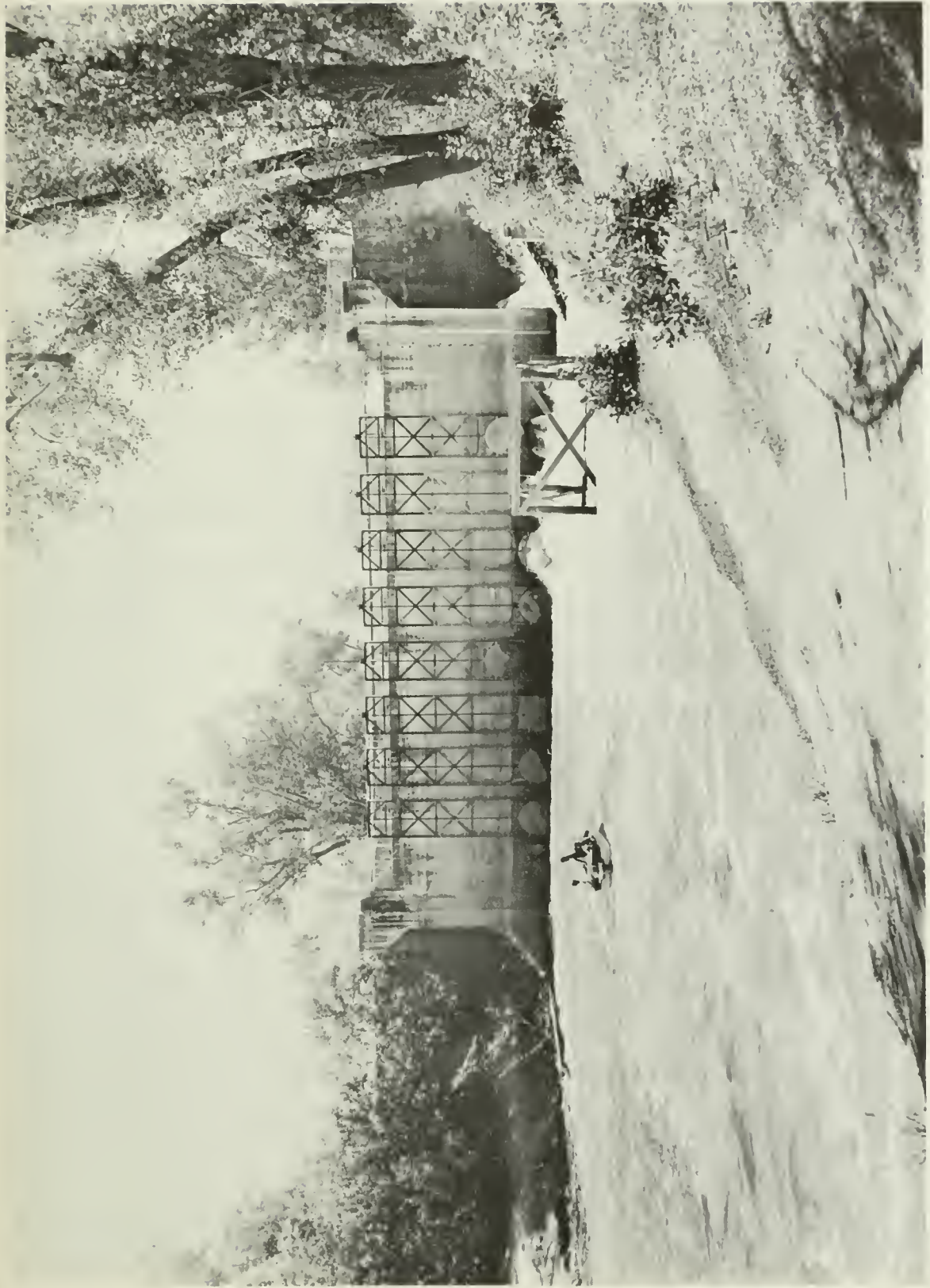

The Sacramento River has always been low during the late summer and fall, and the Knights Landing outfall gates have always been free to discharge large quantities at this time of year.

The principal feature of Reclamation District No. 2047's plan was the Colusa Basin Drainage Canal. South of its junction with Willow Creek the canal proceeds southerly to the vicinity of Colusa and then follows the alignment of the back levee constructed by Reclamation District No. 108 and others. The borrow pits used for obtaining material in building the back levee were utilized for this channel. Considerable excavation was required in some reaches to provide a continuous drainage canal of desired capacity. This canal terminates at the Knights Landing outfall gates on the Sacramento River in Yolo County. The design capacity of this canal is 1,450 second-feet with the elevation of the water surface at a minimum of one foot below the adjoining land so as to provide drainage to the lands along its entire alignment. The canal was designed to convey irrigation return flows from 101,000 acres of rice located in Reclamation District 2047 and in production in 1920.

In addition to this main canal, a branch channel was constructed. This channel followed the common boundary between Reclamation Districts 108 and 787, and connected to the Sacramento River at Eldorado Bend. A pumping plant at this point was originally constructed to pump flood waters into the Sacramento River during periods when the Knights Landing outfall gates were closed because of high stages in the Sacramento River. The pumping plant is not used for flood relief however, but pumps water from the Sacramento River to irrigate several thousand acres adjoining the branch canal and within Reclamation Districts 108 and 787.

The Colusa Basin Drainage Canal also serves as a water supply facility for lands adjoining the canal. To be effective as a source of supply, the water surface must be maintained at a level adequate for pumped diversions. A small control structure with limited outlet capacity at the lower end of the Knights Landing Ridge Cut accomplishes this purpose. The elevation of this control at the mouth of the Knights Landing Ridge Cut is sufficiently low that the major floods, usually occurring during the winter flood season, can be



Colusa Basin Drainage Canal showing back levee of R. D. 108 on left (east). No levee protection on right (west).



A pumping plant on a branch of the Colusa Basin Drainage Canal was originally constructed to pump flood waters into the Sacramento River. However, it is not used for flood relief, but supplies irrigation water to lands in the Colusa Basin.

discharged into the Yolo Bypass. In the fall, when large irrigation return flows are conveyed by the Colusa Basin Drainage Canal, the water level in the Sacramento River is sufficiently low so that the water can be readily discharged through the Knights Landing outfall gates. In the spring, however, irrigation return flows cannot be adequately discharged. At this time, the water level in the Sacramento River usually is too high to permit gravity drainage. Also, discharge of water into the Yolo Bypass creates further problems at this time. The problem of inadequate drainage will be discussed more fully in the next chapter.

Agricultural Development

Settlement of the Colusa Basin commenced shortly after surveys were made by General John Bidwell in the 1840's. Early settlers took up land grants from the Mexican government. Navigation of the Sacramento River and the proximity of available land to the river were responsible for the first settlements taking place along the river. The production of grain became of major importance in the years that followed. Grain raising received its impetus from the demand created by the large number of freight teams hauling supplies to the mines in the Sierra Nevada. Large acreages were planted to dry-farmed wheat and barley; but near the turn of the century, production of those grains declined and the emphasis turned to irrigated crops.

Irrigation Works

In conjunction with the reclamation of the Colusa Basin, irrigation works were developed. Irrigation facilities have been provided by irrigation and other type districts, as well as by individuals. The waters of the Sacramento River initially were developed for irrigation use. After

construction of the Colusa Basin Drainage Canal, irrigation return flows were used by irrigators along this channel.

Irrigation District Developments. One of the earliest irrigation schemes was promoted by Will S. Greene of Colusa in 1864, and was to consist of a large irrigation and navigation canal to serve Colusa and Yolo Counties. Not until after passage of the Wright Act in 1887, however, was progress made toward bringing water from the Sacramento River to the lands. The Central Irrigation District, organized in November 1887, was the fourth irrigation district to form in the State. This district embraced an area of 156,550 acres in what was then Colusa County (now Colusa and Glenn Counties). A portion of the Central Canal was constructed, but financial difficulties postponed progress for several years. In 1903, private interests provided capital to complete the canal and constructed a pumping plant at the river intake. The first water was delivered in 1906. In the years that followed, the district was plagued with numerous problems, involved in litigation, and troubled with financial problems. As a result, six districts were formed between 1916 and 1920 to take over the system and the area originally embraced in the Central Irrigation District. The divided area comprised the Glenn-Colusa District, about one-third of the Jacinto Irrigation District, about half of Provident Irrigation District, and most of Compton-Delevan, Maxwell, and Williams Irrigation Districts. The largest of these is the Glenn-Colusa Irrigation District, which now serves about 112,000 acres.

Table 2 lists the irrigation districts in the Colusa Basin that provided water in 1959, and indicates the acreage irrigated and the amounts of water delivered. The table includes similar information for other water service agencies, as well as for the larger private irrigation developments. The location of the larger public districts is shown on Plate 3.

TABLE 2

PRINCIPAL WATER USERS IN THE COLUSA BASIN
IN 1959

Name	: Water delivered, : in acre-feet	: Presently irrigated : area, in acres
<u>Mutual Water Companies</u>		
Willow Creek Mutual Water Company	(Included with Glenn-Colusa I.D.)	---
Colusa Irrigation Company	1,154	289
Roberts Ditch Company	3,678	1,032
<u>Irrigation Districts</u>		
Glenn-Colusa	824,455	78,700
Jacinto	85,210	9,738
Maxwell	16,000*	4,000
Princeton-Cordora-Glenn	78,673	6,162
Provident	104,856	8,532
<u>Reclamation Districts</u>		
Number 108	192,736	26,215
<u>Federal</u>		
Fish and Wildlife Service	6,572	880
<u>Private</u>		
River Farms	28,541	4,354
O. P. Davis	25,323	3,615
J. H. Zumwalt	17,344	4,848
Charles W. Welch	13,836	2,691
Layton Knaggs	9,880	959
Beckley, et al.	7,662	579
C. W. Tuttle	5,606	848
Seaver and Byington	5,464	784
Fred Schultz	5,144	1,120
Hershey Estate	5,062	720

*Estimated



Many of the pumps are located on feeder canals some distance from the main drainage canal.



In the western and especially northern portions of the basin, ground water pumping provides a water supply.

Private Irrigation Development. Outside of the organized dis-

tricts, private landowners also have constructed irrigation facilities. These developments began at an early date with pumping from the Sacramento River. Somewhat later, following the establishment of a more-or-less firm return flow through the Colusa Basin Drainage Canal, land was brought under irrigation by pumping from the drainage canal and feeder canals. This latter development has been possible because of the very low land gradient adjacent to the drainage canal. A typical installation located on a feeder canal is shown in the top photograph of the facing page. The water is conveyed westward by canals in cut and fill with low pump lifts. Irrigation is then accomplished by gravity. In the western and especially the northern portions of the basin, ground water pumping provides part of the water supply.

The lands along the Colusa Basin Drainage Canal are served either by pump diversions from the canal or by wells or by both in some cases. Many divertors have filed applications for water rights. Filing began shortly after the enactment of the Water Commission Act (Statutes 1913, Chapter 586). Due consideration of these water rights and conditions of use is mandatory in planning for flood control or drainage improvements. In this regard, field investigation and interviews with irrigators showed that in any proposed summer drainage improvement, water levels must be maintained in the Colusa Basin Drainage Canal to permit existing diversions to continue unimpaired.

Proposed Irrigation Development

Large areas of land in the Colusa Basin remain undeveloped, particularly the higher lands to the west. The U. S. Bureau of Reclamation, as

part of the Central Valley Project, has plans to provide water to irrigable lands within the Colusa Basin. The service areas in which irrigation water will become available are indicated on Plate 3.

Water Quality

Water quality is not presently a problem, at least insofar as the quality of an irrigation supply from the Sacramento River or the Colusa Basin Drainage Canal is concerned. Studies by the Department of Water Resources indicate that the quality of water in the Sacramento River will continue to be excellent in future years. Water quality information, particularly that applicable to the Colusa Basin Drainage Canal, was reviewed for this investigation.

Since 1952, a series of periodic water quality samples have been taken from the Colusa Basin Drainage Canal at Highway 20 and Knights Landing. Mineral analyses of these samples indicate a fairly consistent water quality during the irrigation season. Of the 63 samples taken from the lower part of the Colusa Basin Drainage Canal over a period of nine years, only two samples failed to meet the standards of Class I water. Both of these were taken during a very dry spell in April and May 1954.

Fish and Game

Recreation, measured in terms of money spent, is one of the most important activities in the Colusa Basin and is exceeded only by agriculture as a factor in the local economy. Hunting, particularly for pheasant and waterfowl, constitutes the principal form of recreation in this area. The many sloughs, channels, and drains in the Colusa Basin also sustain warm-water game fish. Catfish and largemouth black bass are the principal game fish. Lesser numbers of bluegill and green sunfish are also taken. Most of these game fish appear in the Colusa Basin Drainage Canal and in channels or

ponds on permanently flooded gun club lands along Willow Creek. The numerous irrigation ditches and drainage ways in the area are also heavily fished. Fishing for striped bass and salmon occurs primarily in the Sacramento River.

The Pacific Flyway, one of the four major waterfowl migration flyways within the North American Continent, covers California, Oregon, Washington, Idaho, Montana, Nevada, Utah, and Arizona. Ducks and geese using the Pacific Flyway nest and breed, for the most part, in Alberta and Saskatchewan, and move southward to winter in California, Arizona, and Mexico. The breeding areas have been affected only slightly by man's activities, although wintering areas to the south, particularly in the Central Valley in California, are continually reduced as a result of increases in population and accompanying increases in land use. Consequently, the two areas are seriously out of balance. Waterfowl populations are limited by insufficient wintering areas, even though their northern breeding areas are sufficient to support a larger waterfowl population.

Throughout recorded history, California has been the principal wintering ground for migratory waterfowl of the Pacific Flyway. An estimated 60 percent of Pacific Flyway waterfowl winter in California. Extensive marsh areas in the great valleys of the State were used, prior to reclamation, by hordes of ducks and geese. Today these same valleys have a much reduced marsh and water acreage, and are crowded with waterfowl during the winter season.

Figure 2 shows the several major routes within the flyway as well as the complex of branching routes, concentration points, and interchanges between subflyways. At least seven migration routes converge at the Tule Lake-Lower Klamath concentration area, one of the largest in the nation. From there the birds move in great flocks down into the Central Valley of California.

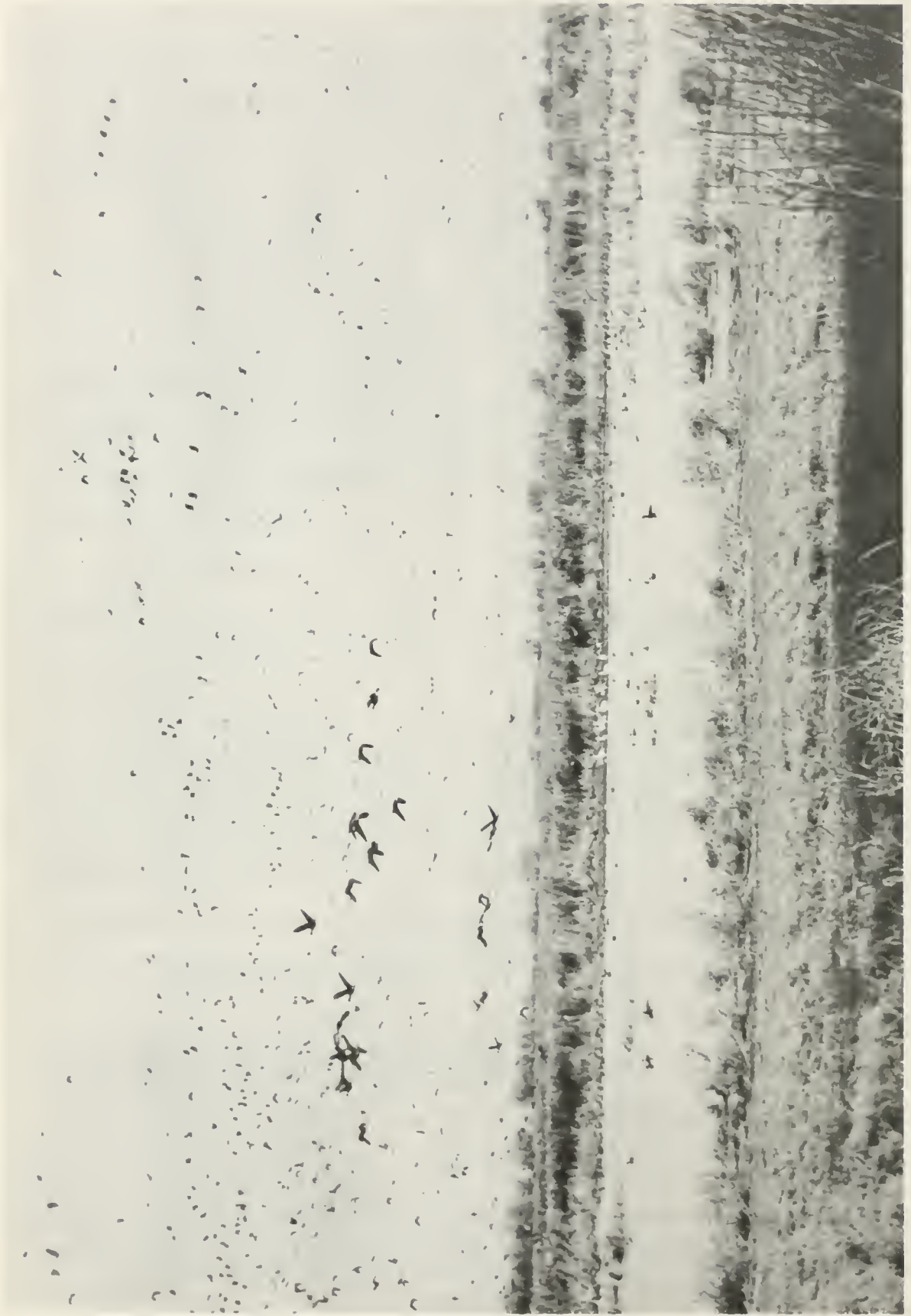

Today these same valleys have a much reduced marsh and water acreage and are crowded with waterfowl during the winter season.

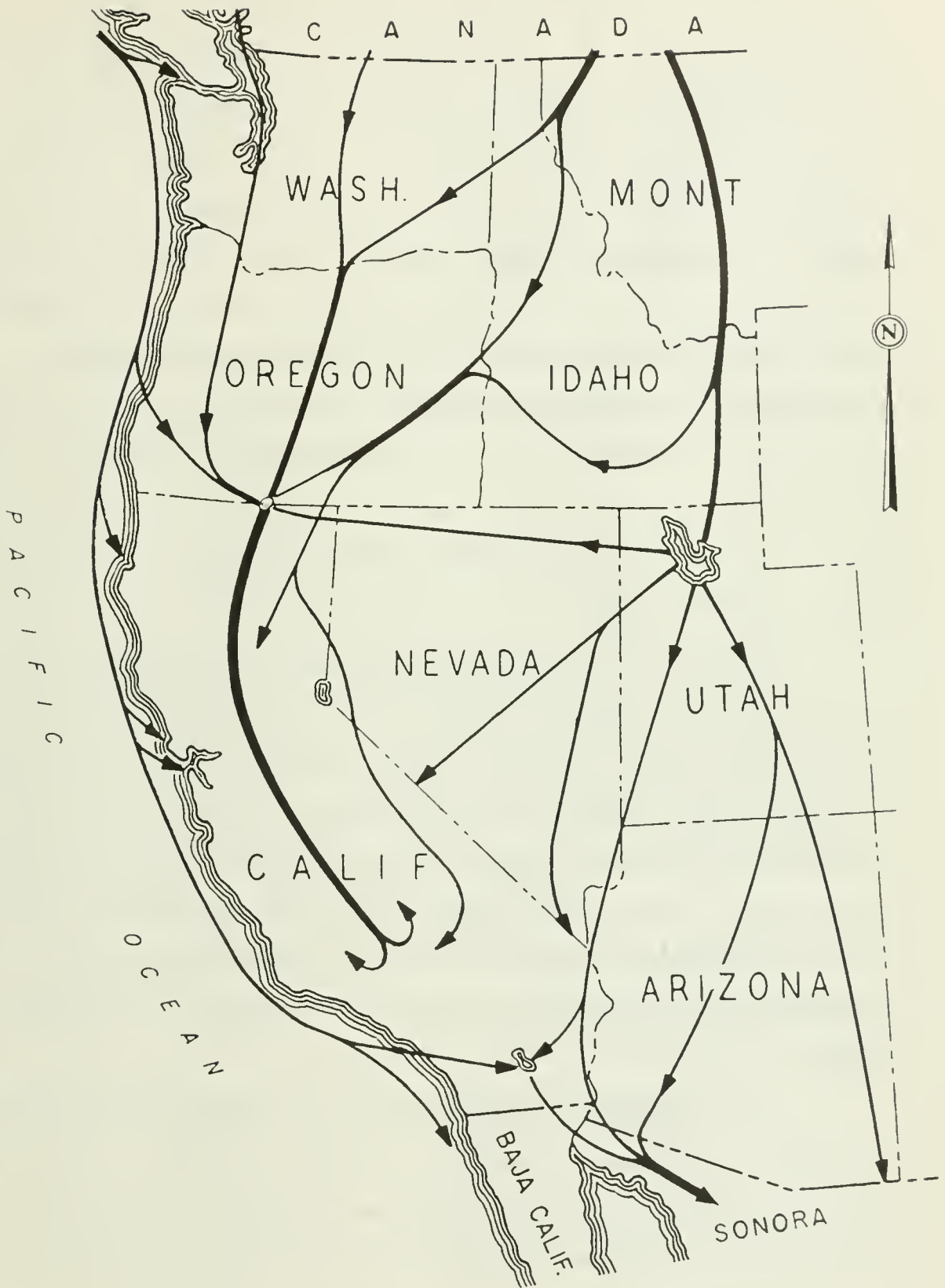

Figure 2. PACIFIC MIGRATORY WATERFOWL FLYWAY, SHOWING PRINCIPAL FALL MIGRATION ROUTES

The Colusa Basin is within the most important wildlife area in the Sacramento Valley. The basin contains two federally-owned national wildlife refuges, the Sacramento National Wildlife Refuge near Willows, and the Colusa National Wildlife Refuge near Colusa. These two refuges, together with the state-owned Grey Lodge Waterfowl Management Area in Butte County, the Sutter National Wildlife Refuge in Sutter County, and adjoining areas provide the bulk of the waterfowl wintering grounds in the Sacramento Valley. This area contains 24,000 acres of federal and state-owned waterfowl refuge and waterfowl management areas as well as an estimated 33,000 acres of privately owned gun club lands in Butte and Colusa Basins. U. S. Fish and Wildlife Service records from 1953 through 1957 show that 78 percent of the 465,000 migratory waterfowl in the Sacramento Valley in September occupy these four refuges.

The state and federally-owned areas serve primarily to supply needed habitat for feeding and resting as well as refuge areas for waterfowl and other species of wildlife. These areas also function to alleviate crop depredation. During the period from August to October before rice is harvested, rice fields are subject to serious monetary losses due to depredation by ducks. Much of this economic loss has been alleviated in recent years by the growing of crops on the state and federal waterfowl areas, and the attraction of birds to these areas during the critical rice harvest period.

The Colusa Basin provides one of the best pheasant producing areas in the State. Each year, Colusa County sustains the heaviest kill of pheasants of any county in the State. Other game birds in the basin include the widely distributed mourning dove and the far less numerous California quail.

Naturally, the wetland habitat associated with waterfowl supports a great variety of wildlife other than game birds. Widely distributed species of these birds include large numbers of shore birds, egrets, herons, swans, grebes, and pelicans. In addition the riparian habitat existing along ditches, drainage, and waste ways supports large numbers of songbirds. These forms of wildlife, as well as the game species, are part of our wildlife heritage.

Skunk, opossum, racoon, fox, otter, mink, and muskrat occur in the basin. Muskrat, damaging as they are to irrigation works and agriculture, provide commerce in the winter months to a few people who trap for furs.

The Colusa Basin is the most heavily hunted area of comparable size in the State. Considerable hunting takes place on lands subject to flooding. In the flood of February 1958, 93,000 acres were flooded. In this area, 21,000 acres are devoted to waterfowl management, either in the Colusa National Wildlife Refuge or in commercial or private gun clubs. Most of the rest of these 93,000 acres are devoted to pheasant hunting. In an average year 72,500 hunter-days are expended in waterfowl hunting and 27,000 in pheasant hunting on the area subject to flooding.

In the Colusa Basin as a whole, 166,000 acres are devoted to pheasant hunting in cooperative or community hunting areas and at licensed pheasant clubs. On these lands, 52,600 hunter-days are expended on pheasant hunting annually, and fees of over \$60,000 are collected.

CHAPTER III. EXISTING AND POTENTIAL FLOOD AND DRAINAGE PROBLEMS

Flood conditions, including those arising from poor drainage, impede agriculture and economic development in portions of the Colusa Basin. Problems of flooding exist along Willow Creek, along the Colusa Basin Drainage Canal and its tributary drainage channels, and in portions of the Yolo Bypass below the Knights Landing Ridge Cut. These problems are caused by improper and insufficient individual farm drainage, inadequate facilities to remove drainage from low lying areas into the Colusa Basin Drainage Canal and other major drainage canals, insufficient channel capacities of flood and drainage canals tributary to the Colusa Basin Drainage Canal, and inadequate discharge capacity of the Colusa Basin Drainage Canal into either the Sacramento River or the Yolo Bypass.

The scope of this investigation was restricted to meet the objectives of Senate Concurrent Resolution No. 79 with available funds and within available time. Problems investigated in detail were those of flooding and drainage along a portion of Willow Creek and along the Colusa Basin Drainage Canal and the inadequate discharge capacity of that canal. Flood and drainage problems along channels tributary to the Colusa Basin Drainage Canal were considered only in connection with their relationship to problems of the main canal. The area of study was limited to that downstream from the Willow Creek area studied by the U. S. Corps of Engineers, and areas downstream from the Glenn-Colusa Irrigation District Canal crossing of Willow Creek just east of the town of Willows. The study area extends downstream along the Colusa Basin Drainage Canal, the Knights Landing Ridge Cut, and the Tule Canal in the Yolo Bypass as far south as the Sacramento Deep Water Ship Channel.

Existing Flood Problems

During the winter flood period, roughly October through March, floods are caused by precipitation within the basin and runoff from the foothill region to the west. The magnitude of the discharge in these winter storms is very large when compared with the channel capacity of the Colusa Basin Drainage Canal. The channel capacity in the upper reaches, for example, is exceeded when the discharge at Highway 20 near Colusa is greater than 2,100 second-feet. The maximum mean daily discharge of record occurred on February 21, 1958, and was 23,900 second-feet at that point. Because the channel is inadequate to handle the discharge, the excess flows flood an extensive area along the channel. In 1958, the flooded area extended continuously from Knights Landing to Orland, a distance of 70 miles. The flooded areas are frequently large at this time of year. but the damages are relatively light since the lands inundated are principally agricultural and idle during the winter. Highways, roads, and public utilities, as well as the limited urban or domestic development within the flood plain, are also subject to damage.

Existing Drainage Problems

In the spring months, April through June, flooding is caused principally by irrigation return flows rather than by precipitation. During the spring, precipitation is generally insignificant. The channel capacity of the Colusa Basin Drainage Canal is usually adequate to handle the irrigation return flows, except in the reach between College City and Knights Landing where flooding of a small area occurs regularly. The resulting damages are large since this flooding occurs in the normal growing season. This spring flooding results from local agricultural

practices which cause irrigation return flows that cannot be dissipated by works constructed to relieve winter flood conditions.

Virtually all of the rice in the Sacramento Valley is planted between April 15 and May 15. In order to control weeds, the rice fields are flooded to a depth of 10 to 12 inches for a period of three to four weeks. In this time, both the rice and weeds germinate, and both would be drowned out if this depth of water were retained. The rice has a somewhat longer life under the deep water, however, and, after the weeds have died but before the rice is harmed, 4 to 6 inches of water is dumped from the fields. The acreage of rice in the Colusa Basin is very large; in recent years, it has averaged around 100,000 acres, reaching a peak of 131,000 acres in 1954. Since the planting and flooding schedule for all this rice is about the same throughout the basin, the dumping practice creates a considerable flow that generally reaches a peak in May. The resulting flow may be augmented by water that must be released from rice fields during sustained north winds prevalent at this time of year. Most rice fields are large and have a considerable fetch, particularly in a north-south direction. Consequently, the water piles up at the south end of the field. In order to protect his checks, the grower must allow part of the ponded water to escape.

Several conditions contribute to the inability of existing works to handle spring flooding. High water in the Sacramento River prevents the drainage water from escaping through the Knights Landing outfall gates into the river. The outlet of the Knights Landing Ridge Cut is inadequate to release the required flow. Backwater resulting from these conditions causes flooding of lands along the west side of the Colusa Basin Drainage Canal. Whatever water does escape into the Yolo Bypass causes additional damage by flooding farm land which has been planted at this time of year.

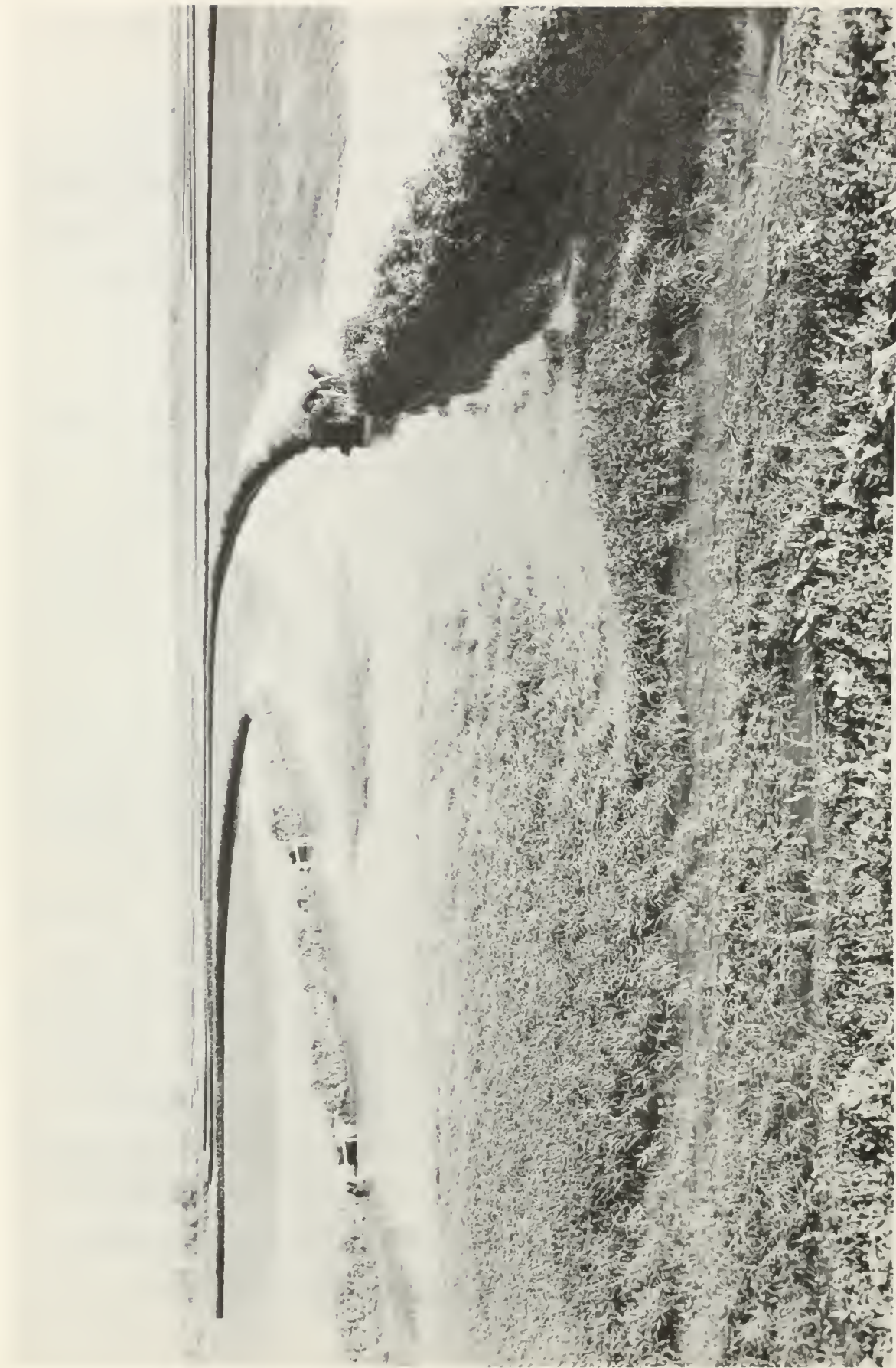

The acreage of rice in the Colusa Basin is considerable, averaging around 100,000 acres in recent years.

In the early years of this century, when the Knights Landing Ridge Cut and the Colusa Basin Drainage Canal were constructed, there was no agricultural development along the west bank of the drainage canal. Overflow onto these low lying lands was expected to occur whenever the outfall gates at Knights Landing were closed. Now conditions have changed, and lands right up to the bank have been brought into production. To protect their operations, some landowners along the drainage canal have built low levees at the water's edge. These levees raise the water surface still further. As a result, both the flows through the ridge cut and the spring-time damages in the Yolo Bypass are increased.

Table 3 compares the size of the spring peak discharge with the average July discharge and the fall peak discharge. The latter results primarily from the draining of rice fields prior to harvest.

TABLE 3
 FLOWS IN COLUSA BASIN DRAINAGE CANAL
 AT HIGHWAY 20 BRIDGE

Year	: Acreage of rice : in Colusa Basin, : in acres ^{1/}	: Date of : Spring : peak	: Discharge, in second-feet ^{2/}		
			: Spring : peak	: July : average	: Fall : peak
1960	No record	May 26	1,730	744	1,570
1959	91,700	May 7	1,340	709	1,360
1958	82,000	May 26	2,030	881	1,400
1957	78,000	May 12	1,630	733	1,620
1956	88,000	May 8	1,650	744	1,480
1955	96,000	May 19	1,400	664	1,710
1954	131,000	June 11	1,390	330	1,800
1953	111,000	May 28	1,790	340	2,010
1952	96,000	July 1	1,190	591	1,490
1951	90,000	May 5	1,340	610	1,560
1950	77,000	May 7	1,100	480	1,530

^{1/} Irrigated from Colusa Basin Drainage Canal or Sacramento River.

^{2/} Mean daily.



Some landowners along the drainage canal have built low levees at the water's edge.

Although the large fall peak discharges often equal or exceed those of the spring, they have never flooded areas in the Colusa Basin. The absence of fall flooding is due to two facts: (1) The Knights Landing outfall gates at the lower end of the Colusa Basin Drainage Canal always have been free to discharge large quantities of water without serious backwater effects during the late summer and fall when the Sacramento River is normally low; (2) In neither the spring nor the fall have irrigation return flows exceeded the channel capacity of the canal unless they were accompanied by the serious backwater effects which result only from the closing of the Knights Landing outflow gates on account of high river stages.

Since the Colusa Basin Drainage Canal has virtually no capacity for channel storage, flows of the magnitude of those listed in Table 3 will pond a large quantity of water when even a brief damming of the flow occurs. In the spring, the Sacramento River often rises high enough to close, at least partially, the outfall gates. Between April 1 and June 1 in 15 of the past 40 years, the water has overflowed the banks of the drainage canal between College City and Knights Landing.

Flooding in the Yolo Bypass is coincident with this flooding in the lower Colusa Basin. High stages at the lower end of the Colusa Basin Drainage Canal cause flows through the Knights Landing Ridge Cut into the Yolo Bypass. From the mouth of the ridge cut to the Tule Canal on the opposite side of the bypass, the capacity of two channels that meander through the Yolo Bypass is about 100 second-feet. Any flow in excess of 100 second-feet overflows the banks of these two channels and crosses the bypass from west to east as a sheet. The capacity of these channels is often exceeded because large flows come through the ridge cut in the springtime when the outfall gates at Knights Landing are closed.



Two small meandering channels constitute the only outlet from the Knights Landing Ridge Cut which is shown above entering the Yolo Bypass from the lower right corner of the photograph.



Any flow in excess of 100 second-feet crosses the Yolo Bypass as a sheet.

The Tule Canal, located on the east side of the bypass, conveys the water southward as far as the toe drain of the Sacramento Deep Water Ship Channel. The discharge capacity of the Tule Canal is seriously restricted in the reach from the Sacramento Bypass to Highway 40. Backwater in the Tule Canal causes additional flooding within the Yolo Bypass.

Potential Flood and Drainage Problems

Future flood problems can be expected to be the same as those experienced in the immediate past, except as altered by water projects and land development. Foreseeable works which could alter such problems can be arranged into three groups: (1) The construction of major water development works outside the project area could cause changes in the flow of the Sacramento River; (2) improvements on the channels tributary to the Colusa Basin Drainage Canal could cause changes in flood flows from tributary channels; (3) changes in land use in Colusa Basin drainage area could modify drainage and runoff patterns. The possible effects of each of these factors are discussed in the following three sections. A fourth possible work of man which might alter flood problems, that of a major drainage channel for water pollution control in the Sacramento Valley, was not evaluated.

Construction of Major Works Outside the Project Area

Because the Colusa Basin lies on the floor of the Sacramento Valley, the drainage of this area will probably be affected by major changes in the regimen of the Sacramento River. Changes in the regimen of the Sacramento River may result from the construction of storage reservoirs on the tributaries of the Sacramento River or from changes in the operation of existing reservoirs. These operational changes could take place as new projects are activated in the Central Valley and as water is imported to or

exported from the valley. The construction of the Feather River Project and the importation of water from the North Coastal Area are among such developments. The Sacramento River could be used as a canal to convey imported water from the North Coastal Area to the Delta for use in the Sacramento Valley and for transfer to areas of deficiency south of the Delta. It is conceivable that the importation of this water could hold the river stage at Knights Landing high enough to close the outfall gates at times during the summer.

In the winter, a significant amount of new reservoir storage in the Sacramento Valley would reduce flood peaks in the river. Under such conditions, winter floods, often trapped in the Colusa Basin, might be able to escape into the river. However, this possibility is remote because at even moderate 20,000 second-foot flows in the Sacramento River, the Knights Landing outfall gates will be closed. The additional reservoir storage shown to be needed in the Sacramento Valley probably would not reduce major flood peaks in the river to this 20,000 second-foot level.

No predictions of flows in the Sacramento River under future conditions have been attempted as part of this study. However, two reasonable assumptions concerning such future flows may be made: (1) Under future winter flood conditions in the basin, the outfall gates to the river will be closed as they have been in all major historic floods; (2) in the summertime, sustained flows sufficient to close the outfall gates may be reached in 50 to 60 years. Because this latter possibility is not likely for many years, its effect was not taken into account in planning flood control works in this investigation. Further, it was assumed that if a potential flood condition were created by water development projects, those responsible for the project would be required to alleviate the situation.

To summarize: Future water developments in the Sacramento River Basin will not significantly relieve winter floods in the Colusa Basin, but potentially could cause summer or fall damages not presently experienced which would be corrected by those responsible therefore, if and when such occurred.

Improvement of the Channels Tributary to the Drainage Canal

The present principal source of major floods in the Colusa Basin is runoff from tributary streams originating in the west side foothills (see Plate 1). These tributaries are small but their flood crests develop quite rapidly. Where these streams cross the valley floor, their channels are generally too small to convey the flood flows directly to the Colusa Basin Drainage Canal without flooding adjacent lands. This condition reduces peak flows and slows the entry of flood waters into the drainage canal.

Despite such flooding, orchards are grown along these tributaries without experiencing serious damage. The slight damage which does occur is usually in the nature of a nuisance. Furthermore, flood waters that leave the channels spread over adjacent lands and recharge the ground water basin. If flooding were prevented by means of improvements along the tributary channels, one of the important sources of ground water recharge would be eliminated.

The most serious damage occurs when the tributary flood flows that enter the Colusa Basin Drainage Canal combine and cause flows greater than the channel capacity. Consequently, a large amount of overflow occurs as the flood waves pass slowly down the valley from north to south.

Under present conditions the flood crests from the southern tributaries pass through first and are receding when the peak crest from the combined northern tributaries reaches the lower end of the basin. Levee and channel improvements on the tributary streams would increase the peak

flows through the Colusa Basin Drainage Canal. Hydrologic studies for this investigation were made with the assumption that the channel capacities of the tributaries would not be improved.

Changes in Land Use in Colusa Basin Drainage Area

Changes in land use are a third factor which could alter future flood and drainage problems in the Colusa Basin.

Floods during the winter period are caused by precipitation on the drainage area. It was assumed that, since the valley area contributes little runoff to the major flood peaks, land use changes on the valley floor will not significantly influence the magnitude or frequency of occurrence of large winter floods.

The smaller flood discharges resulting from irrigation return flows would be modified by the development of additional irrigated land. The crop pattern, particularly that of rice acreage, on both the newly developed and the presently irrigated area would have an influence on the spring and fall drainage floods.

To consider the effect of projected changes in land use and crop pattern, estimates were made of both the distribution of floods within the seasonal periods and the probable flooded area. The predicted pattern of land use assumed complete development of the service area of the U. S. Bureau of Reclamation's Colusa-Tehama Canal and Yolo-Zamora projects. The future crop pattern was applied to the area presently irrigated as well as to these new lands. Under the predicted conditions, a larger percentage of the smaller drainage flood discharges would occur in the summer, but there would be little appreciable change in the time of occurrence and size of damaging drainage floods. Therefore, for the purposes of this investigation, the frequency and size of drainage floods were assumed to remain the same for future conditions as they are for present conditions.

Flood Analyses

Flood hydrology studies were made to provide a basis on which to design projects to prevent flood damages, and also to analyze the benefits derived from such projects. Such studies included investigations into:

(1) The frequency and degree of flooding; (2) the characteristics of flood hydrographs; (3) the annual distribution of floods; and (4) the extent of flooding.

To facilitate the analyses of floods, the flooded area was divided into the six reaches shown on Plate 1. Reach 1, the northern Yolo Bypass, extends from the Sacramento Deep Water Ship Channel northward to the mouth of the Knights Landing Ridge Cut. Reaches 2 through 5 extend northward along the Colusa Basin Drainage Canal and Willow Creek. Reach 2 lies between Knights Landing and College City; Reach 3, between College City and Highway 20; Reach 4, between Highway 20 and the Colusa-Glenn County line; Reach 5, between the Colusa-Glenn County line and Willows. Reach 6, an area northwest of Willows, was considered briefly in the study of the foothill reservoir system.

Frequency and Degree of Flooding

Studies of flood frequency were based upon historical records of precipitation and flood runoff in the Colusa Basin. A statistical determination was made of the possibility of occurrence of various sizes of floods. The February 1958 flood in the Colusa Basin in Reaches 3, 4, and 5 was of a size that probably would be equalled or exceeded two percent of the time, or an average of once-in-50-years. The expression of probability of annual occurrence of various sizes of floods as a percentage is preferred because it does not imply that this size of flood occurs only at widely spaced intervals.

Figure 3 shows the probability of annual occurrence of various sizes of floods in Reaches 3, 4, and 5. This probability was determined by statistical analysis of records of flood discharge of the Colusa Basin Drainage Canal at Highway 20 near Colusa. The gaging station on the canal at Highway 20 measures all the flow from Reaches 4 and 5, and is considered to be representative of the flow continuing through Reach 3.

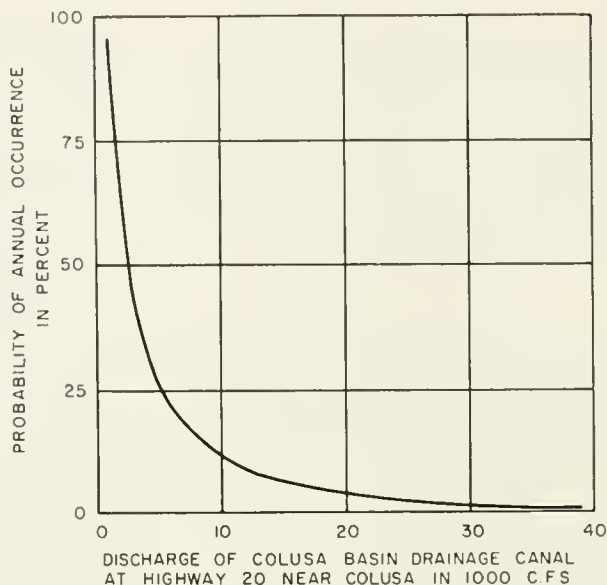
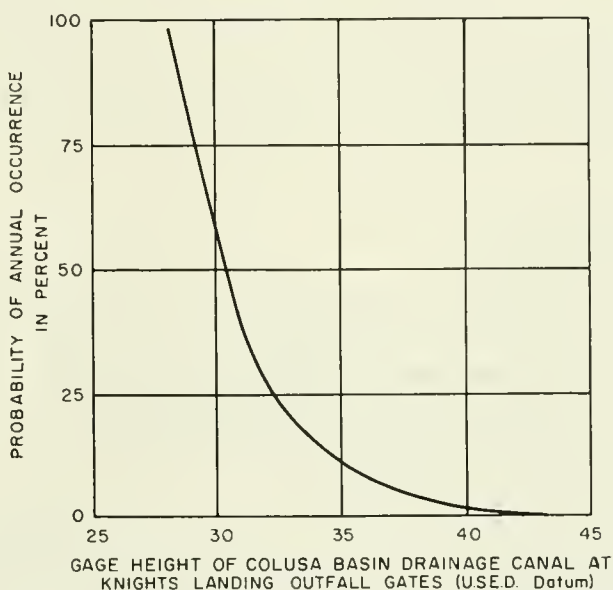

**Figure 3. FREQUENCY OF FLOODING
IN REACHES 3, 4, AND 5**

On February 21, 1958, the mean daily discharge of the Colusa Basin Drainage Canal at Highway 20, was 23,900 second-feet. Because the channel capacity of the drainage canal in this vicinity is about 2,100 second-feet, flooding occurs when this flow is exceeded. There is sufficient slope in the drainage channel in Reach 3 that this reach is not influenced by backwater conditions prevalent in Reach 2.

In Reach 2, the degree of flooding can be related more satisfactorily to the water stage in the Colusa Basin Drainage Canal at the Knights Landing outfall gates than to flood discharge. Factors other than flood

discharge from the tributary area have a marked effect upon the degree of flooding. A high stage in the Sacramento River and flow through the Yolo Bypass, combined with only a minor flood discharge from the tributary area, can cause backwater in the drainage canal and significant damage in this reach. The probability of annual occurrence of various sizes of floods in Reaches 1 and 2 in terms of gage heights of the Colusa Basin Drainage Canal at the Knights Landing outfall gates is shown in Figure 4. In the 1958 flood, the stage in the drainage canal reached a peak elevation of 36.7 feet (USED datum).



**Figure 4. FREQUENCY OF FLOODING
IN REACHES 1 AND 2**

Characteristics of Flood Hydrographs

Flood hydrographs were prepared for the Colusa Basin to provide information relating to peak discharges, the time required for a flood to pass through the basin and total quantity of water involved in a flood. Basically, a flood hydrograph is prepared by plotting the actual or estimated discharge of a stream at intervals of two to eight hours throughout the duration of the flood. The result is a graph, or picture, of the rise and fall of the stream as the flood passes a given point. This information was used primarily in designing works to alleviate flooding.

Typical flood hydrographs were developed for each of the tributary areas. Preparation of such hydrographs postulated quantities of flood runoff resulting from a uniform amount of precipitation on each watershed and used the pattern of the hydrograph experienced in the February 1958 flood. These synthetic floods were combined and routed through the existing channels to determine the extent of flooded areas possible under present conditions. Also, the same synthetic floods were combined and routed through proposed systems of protective works to determine the effectiveness of the proposed works. The same characteristics, or sequence of time and volume, of the typical hydrograph were assumed to prevail for all sizes of floods.

Annual Distribution of Floods

The seasonal variation in flooding was determined from analysis of historical discharges of the Colusa Basin Drainage Canal at Highway 20 and historical stages at the Knights Landing outfall gates. For this purpose, the year was divided into three time periods as an aid to the economic analysis of flood damage to crops. As previously stated, the greatest monetary damage occurs during the spring floods.

Tables 4 and 5 show the amount of flooding during each of the time periods selected. Table 4, representing Reaches 3, 4, and 5, indicates that nearly all floods larger than 11,000 second-feet at the Highway 20 Bridge will occur during the period February 1 through March 31. However, eight percent of the floods smaller than 2,400 second-feet, including the spring drainage floods, will occur during the period April 1 through September 30. Table 5, representing Reaches 1 and 2, shows that nearly all flood stages higher than 35 feet (USED datum) in the Colusa Basin Drainage Canal at the Knights Landing outfall gates will occur during the two

TABLE 4

ANNUAL DISTRIBUTION OF FLOODS
IN REACHES 3, 4, AND 5

Magnitude of flood, in second-feet:	Probable number of floods per 100 years	Time of year of flooding, in percent of time		
		April 1 through Sept. 30	Oct. 1 through Jan. 31	Feb. 1 through March 31
27,000	2	--	--	100
11,000	10	--	1	99
5,000	25	2	33	65
2,400	50	8	51	41

TABLE 5

ANNUAL DISTRIBUTION OF FLOODS
IN REACHES 1 AND 2

Flood stage: at Knights Landing outfall gates, in feet*	Probable number of floods per 100 years	Time of year of flooding, in percent of time		
		April 1 through Sept. 30	Oct. 1 through Jan. 31	Feb. 1 through March 31
39.5	2	--	23	77
35.2	10	1	28	71
32.5	25	3	39	58
30.4	50	7	45	48

* USED datum.

consecutive periods extending from October 1 through March 31. About seven percent of the floods reaching 30 feet will occur during the period April 1 through September 30.

Extent of Flooding

The extent of the area flooded in each reach at various discharges or water levels in the Colusa Basin Drainage Canal was determined through study of the records of historical flooding and of measurements taken from topographic maps. For each reach, the relationship between the probability of annual occurrence, in percent, and the extent of the flooded area, in acres, was determined. Curves depicting this relationship are presented in Figure 5. For Reach 1, the northern Yolo Bypass, Figure 5 depicts only those conditions existing during the period April 1 through September 30. Flood conditions in the bypass during the winter periods were not considered because the bypass lands are established to convey winter flood waters.

Flood Damages

The probable frequency of flooding and the extent of the areas flooded in each of the reaches are measures of flood damage. However, economic evaluation of the proposed projects requires that damages be expressed in monetary values. The benefits derived from any flood control project are measured by the difference in monetary damages occurring before the project and those occurring after construction of the project.

Interviews with about half the landowners in the areas subject to flooding provided detailed information on the extent and cost of flood damages experienced in recent floods. The area farmed by the landowners represented considerably more than half of the total flood area. Local officials, county farm advisors, representatives of irrigation districts,

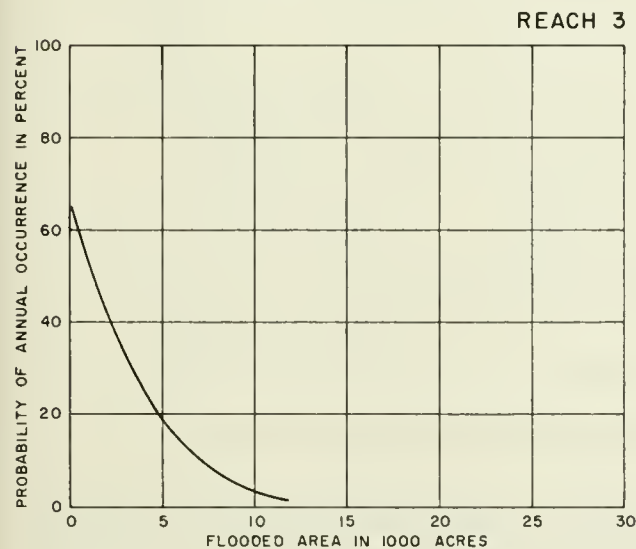
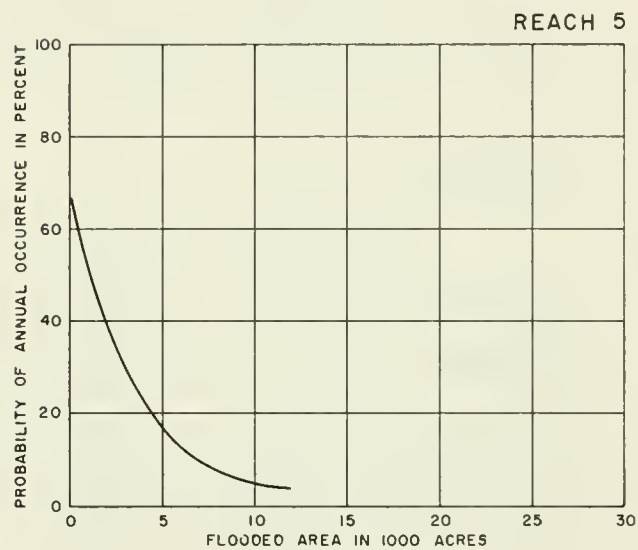
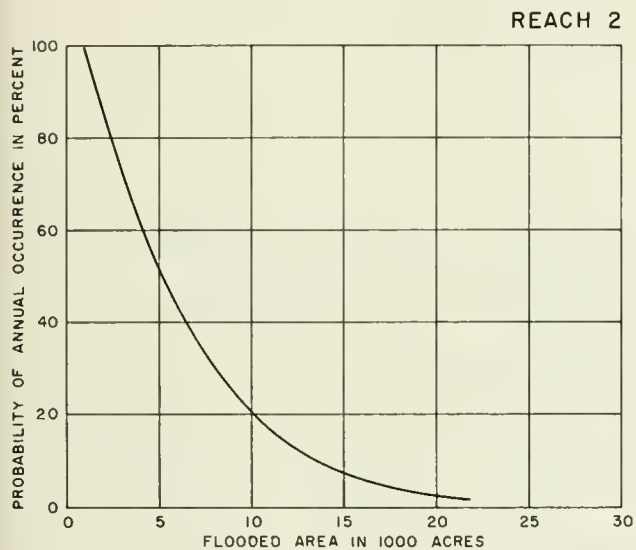
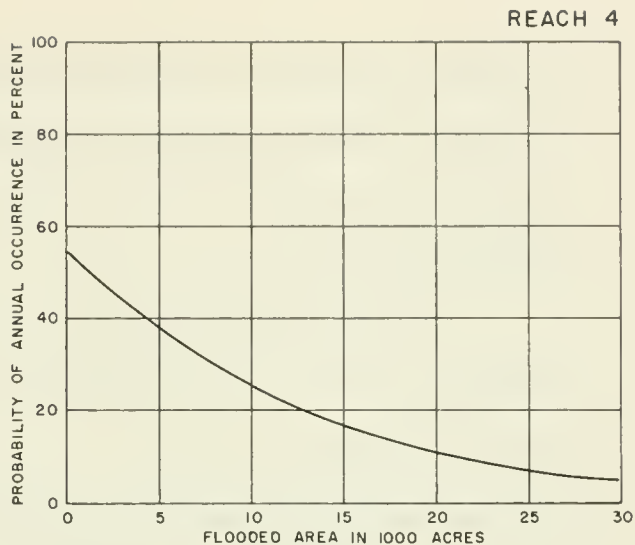
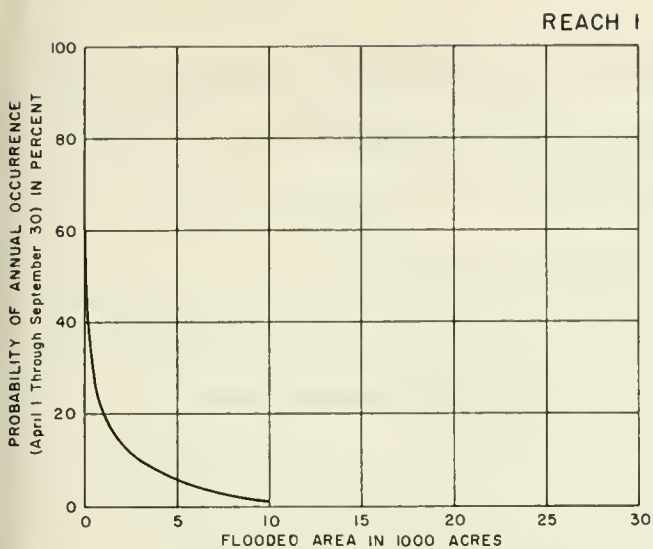

REACH	LOCATION
1	NORTHERN YOLO BYPASS
2	KNIGHTS LANDING TO COLLEGE CITY
3	COLLEGE CITY TO HIGHWAY 20
4	HIGHWAY 20 TO COLUSA-GLENN COUNTY LINE
5	COLUSA-GLENN COUNTY LINE TO WILLOWS

Figure 5. PROBABILITY OF FLOODING IN COLUSA BASIN AND YOLO BYPASS

and others also supplied information used by the Department of Water Resources to evaluate monetary damages. These damages are based upon the price level of crops, their yield per acre, and associated costs of production that prevailed during the 5-year period from 1952 through 1956.^{1/}

In the predominately agricultural Colusa Basin area, most monetary flood damage occurs as crop damage; the rest, as miscellaneous damage to public and private facilities. Data developed by the U. S. Corps of Engineers showed that, during the floods of February to June of 1958, damages to an area of 62,000 acres in the Colusa Trough amounted to \$985,000, an average of about \$16 per acre.

Crop Damage

Crop damages are those losses directly caused by the flooding of agricultural land. Crop damages can occur during every stage of plant development as well as during periods of land preparation prior to the actual planting of the crop. They include reductions in yield and quality resulting from plantings delayed by early floods or partially destroyed by floods of short duration, and losses incurred in replanting crops completely or partially destroyed by flooding. Both the loss of original expenses incurred in raising such crops, and the loss of income which would have been received from their sale contribute to crop flood damages. Estimates of damages in this investigation comprise only those that accrue to the primary producer, or farmer, but not to secondary processors.

Crop damages vary greatly according to the time of year when flooding occurs. A relatively small flood during the growing season may cause

^{1/} The Department of Water Resources currently (1962) uses the 5-year period from 1952 through 1956 as a base period for prices and costs in evaluating the economics of future agricultural development.

more crop damage than a large winter flood. Table 6 shows estimated flood damages per acre to representative crops during three selected periods of the year.

TABLE 6

ESTIMATED CROP DAMAGE RESULTING FROM FLOODING
IN REACHES 1, 2, 3, 4, AND 5

(In dollars per acre)

Crops	Time of year of flooding		
	April 1 through September 30	October 1 through January 31	February 1 through March 31
Truck crops			
Tomatoes	\$195.00	\$3.80	\$15.00
Beans	94.00	2.00	5.00
Field crops			
Sugar beets	146.00	3.00	35.00
Milo	65.00	2.00	4.30
Safflower	70.00	2.00	4.50
Rice	*	5.80	5.80
Barley	60.50	46.00	52.00
Alfalfa	83.00	5.00	31.00
Pasture	57.00	3.70	20.00
Double crops			
Beans-barley	59.00	44.50	50.50
Sugar beets- barley	65.00	50.50	56.50
Milo-barley	49.00	34.50	40.50
Rice-barley	50.20	35.70	41.70

* \$46.00 per acre in Reaches 3, 4, and 5; \$92.00 per acre in Reaches 1 and 2.

For a flood of a particular magnitude, the weighted average annual damage per acre to each crop in a particular reach is the sum of the products for each period of the frequency of occurrence in the reach of that size flood and the damage to the crop. In Reach 3, for example, a

flood of a magnitude whose annual frequency of occurrence is 25 percent would result in a weighted average annual damage per acre to barley of \$50.19. This figure was derived from Tables 4 and 6 as follows: Table 4 shows that of those floods in Reach 3 whose annual frequency of occurrence is 25 percent, two percent occur in the period from April 1 through September 30, 33 percent in the period from October 1 through January 31, and 65 percent in the period from February 1 through March 31. Table 6 shows that barley would sustain crop damage of \$60.50 an acre, \$46.00 an acre, and \$52.00 an acre, respectively, in the same three periods. The weighted average annual damage per acre of barley, therefore, is the sum of two percent of \$60.50, 33 percent of \$46.00, and 65 percent of \$52.00.

In a similar manner, the weighted average annual damage per acre was developed for the range of flood sizes which could affect each crop which might be grown within the areas subject to flooding.

After having established crop damage per acre, it became necessary to determine the present and predicted future acreage devoted to each crop. The product of crop damage per acre and the acreage devoted to each crop equals the total damage to each crop. This total damage was computed for various sizes of floods. The crop pattern of crops flooded in any part of a reach was assumed to be the same as that in the entire reach.

The present pattern of crop acreage in each reach was determined by appropriately adjusting data provided by a land use survey made in 1954 for Department of Water Resources Bulletin No. 58, "Northeast Counties Investigation." Estimates of the crop pattern as it would be in the future without additional flood protection were based upon the soil types in each reach, the suitability and adaptation of certain crops to each reach, and

the anticipated economic trends affecting each reach. The crop pattern was assumed to change from the existing to the future pattern uniformly in the first ten years and to remain constant thereafter. Table 7 summarizes the net acreage devoted to each crop within each reach under existing and predicted future conditions without additional flood protection. Lands now used as hunting areas for gun clubs are assumed to continue in the same category in the future.

Figure 6 shows graphically the probability of present and future crop damages, in Reaches 2, 3, 4, and 5, resulting from various sizes and frequencies of floods. The frequency-damage relationships depicted in this graph were used to determine an estimated average annual equivalent crop damage for a 50-year period. This crop damage, as it would occur without construction of flood protection works, averages \$150,000 a year. This amount does not include crop damages which would occur in the area along the Colusa Basin Drainage Canal for which a flood easement would be purchased in connection with flood protection works discussed in Chapter 4.

Miscellaneous Damage

Miscellaneous damage includes damage to such public facilities as highways, roads, communication systems and irrigation works, damage to such private facilities as pumping plants, irrigation and drainage systems, fences, farm equipment, and personal property; damage from weed infestations resulting from weed seeds carried by flood waters; and damage to areas used for waterfowl management and by duck clubs.

Public and private facilities subject to flooding within the Colusa Basin area are few, however. A significant amount of miscellaneous damage is physical damage to property used in waterfowl management and to property belonging to duck clubs. This damage was estimated at three dollars

TABLE 7

PRESENT AND ESTIMATED FUTURE CROP PATTERN WITHOUT ADDITIONAL FLOOD PROTECTION
IN REACHES 1, 2, 3, 4, AND 5

(In acres)

Land Use	Reach 1		Reach 2		Reach 3		Reach 4		Reach 5	
	Present	Future	Present	Future	Present	Future	Present	Future	Present	Future
Truck crops										
Tomatoes	510	600	250	890	50	110	---	630	---	730
Beans	550	640	250	370	110	160	---	210	---	---
Field crops										
Sugar beets	---	---	1,380	1,500	490	610	---	1,680	---	1,090
Milo	970	1,060	500	510	270	220	420	630	280	---
Safflower	1,060	1,100	500	1,000	220	220	420	1,050	280	630
Rice	1,510	1,200	6,260	5,120	2,530	2,740	13,640	12,810	6,510	5,500
Barley	---	---	1,870	1,860	660	710	1,680	2,100	740	1,100
Alfalfa	---	---	750	630	330	270	---	210	---	---
Pasture	---	---	750	630	820	440	4,840	1,680	3,190	1,950
Total cropped	4,600	4,600	12,510	12,510	5,480	5,480	21,000	21,000	11,000	11,000
Uncropped*	3,200	3,200	5,290	5,290	4,220	4,220	16,200	16,200	3,000	3,000
Total	7,800	7,800	17,800	17,800	9,700	9,700	37,200	37,200	14,000	14,000

*This item includes non-farmed gun club lands.

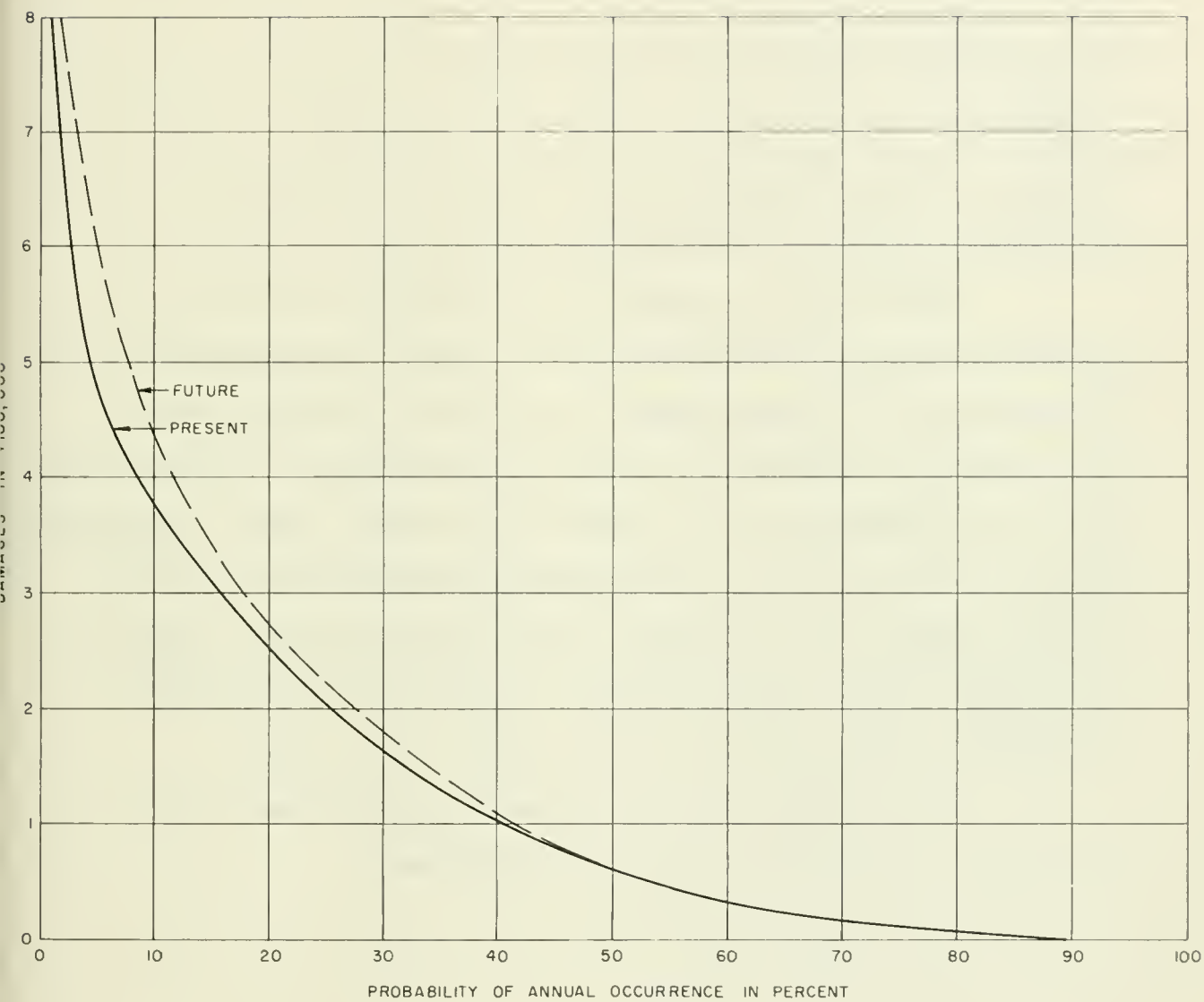

Figure 6. PROBABILITY OF CROP DAMAGES
IN REACHES 2,3,4, AND 5

a year per flooded acre. No monetary value was placed on damage to recreation enjoyment through the loss of hunting opportunity. A reasonable analysis of this type of damage was not possible with the meager data available. Although this loss is significant in some years, qualitative studies indicate that it becomes only slightly significant when reduced to an annual probability of occurrence during the legal hunting season. Although floods interfere with hunting opportunity, the waterfowl population benefits from the increased resting and feeding areas available to it during floods.

Field surveys and studies by other agencies provided the data required to obtain estimated miscellaneous damages resulting from several recent floods. After these damages were plotted on a graph according to the frequency of occurrence of the size of flood involved, a projection was made of flood damages for a full range of flood sizes. Figure 7 graphically summarizes the magnitude of miscellaneous damage expected for floods of various probabilities of occurrence. Without additional flood protection, an estimated average annual equivalent miscellaneous damage of \$46,000 would occur during a 50-year period in Reaches 2, 3, 4, and 5.

Table 8 summarizes flood conditions and flood damages in the Colusa Basin under present conditions of development.

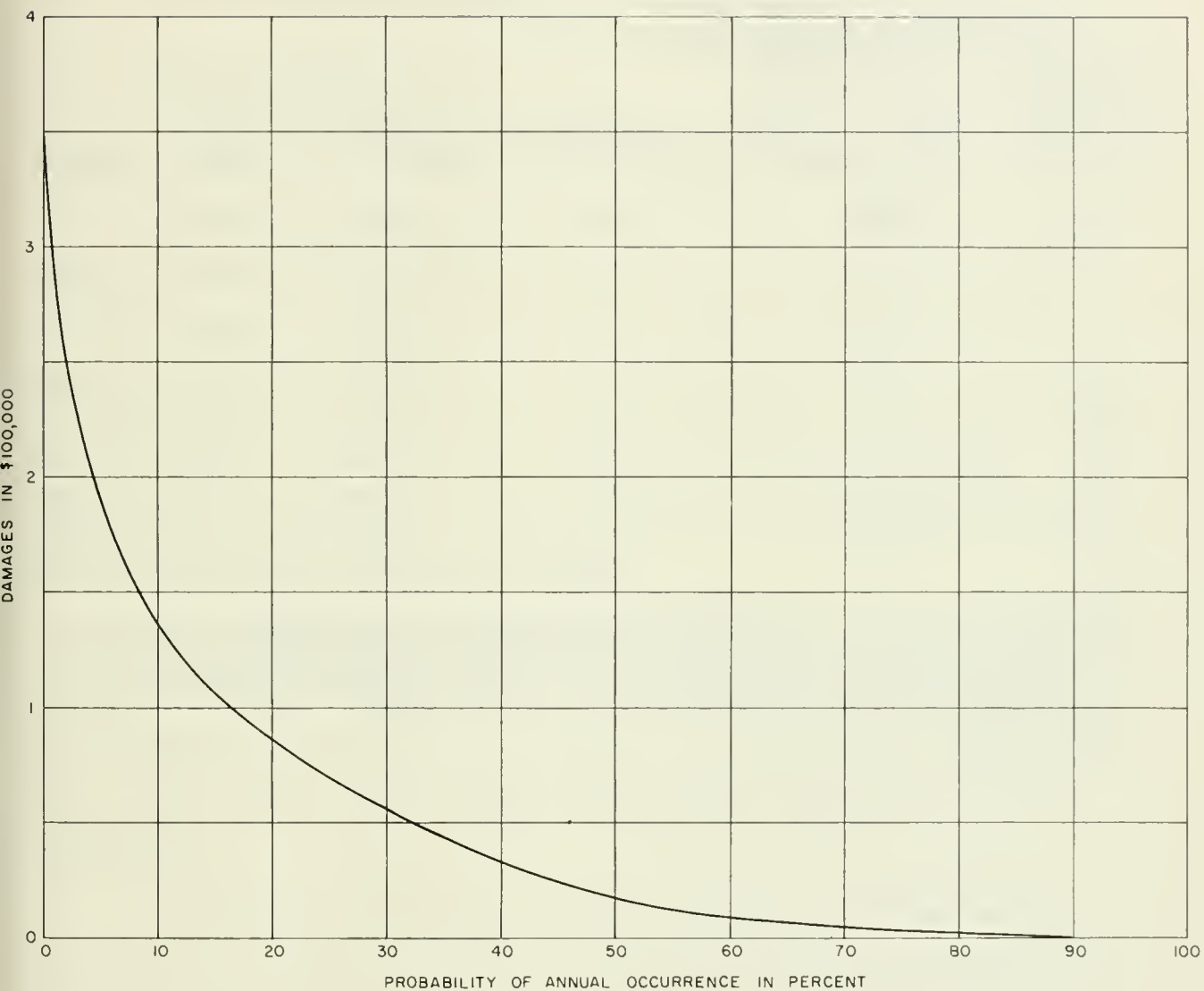

Figure 7. PROBABILITY OF MISCELLANEOUS DAMAGES
IN REACHES 2, 3, 4, AND 5

TABLE 8

FLOOD CONDITIONS AND PRESENT FLOOD DAMAGE
IN REACHES 2, 3, 4, AND 5

Estimated flood conditions			Estimated flood damage, in dollars*			
Probability: of annual occurrence, in percent	Flood discharge of Colusa Basin Drainage Canal at Highway 20 Bridge, in second-feet	Gross flooded area, in acres	Miscellaneous: damage	Crop damage	Total	
2	25,000	83,000	246,000	700,000	946,000	
5	18,000	65,000	190,000	480,000	670,000	
10	11,000	49,000	136,000	380,000	516,000	
20	6,000	32,000	85,000	254,000	339,000	
30	4,000	23,000	56,000	167,000	223,000	
40	3,000	17,000	33,000	105,000	138,000	
50	2,400	13,000	17,000	64,000	81,000	

*For the purposes of subsequent project analysis, these estimates do not include flood damage on 4,600 acres of land along the Colusa Basin Drainage Canal that would be within the flood channel, if a levee project were built.

CHAPTER IV. POSSIBLE SOLUTIONS

In this investigation the following four possible solutions to flood problems of the Colusa Basin were considered: (1) systems of levees along the Colusa Basin Drainage Canal; (2) flood control reservoirs in the western foothills; (3) watershed management; and (4) improved drainage facilities from the Knights Landing Ridge Cut through the Yolo Bypass.

These plans were designed to operate without interference to water rights or diversion of waters from drainage channels in the Colusa Basin.

Detailed engineering studies and economic analyses showed that levees constructed along the Colusa Basin Drainage Canal would not be economically justified. Three such projects, the Colusa Basin Levee Projects, are summarized in this chapter. Additional details of the investigation are on file at the Department of Water Resources.

The investigation of flood control reservoirs in the western foothills, the Foothill Reservoir Project, was conducted to the point where it became apparent that the project would be more costly than any of the Colusa Basin Levee Projects. This chapter summarizes data developed during the investigation.

Limitations of time and funds permitted only brief consideration to be given to practices of watershed management which might minimize flood problems of the Colusa Basin. Such consideration as was given is summarized in this chapter.

The construction of improved drainage facilities in the northern portion of the Yolo Bypass proved to be an economically justified solution to problems created by limited flood volumes in a limited area. This project, the Yolo Bypass Project, was thoroughly investigated. The results of this investigation are described in this chapter.

Colusa Basin Levee Projects

Each of the Colusa Basin Levee Projects would consist of a continuous system of levees on both sides of the Colusa Basin Drainage Canal from Knights Landing to the canal's junction with Willow Creek and along Willow Creek to a point near Willows. The canal itself would continue to function as the main drainage channel of the Colusa Basin. The main flood channel within the basin would be that formed by the existing canal and an area varying from 1,000 to 450 feet in width between the levees.

Additional levees to be constructed along streams tributary to the canal would convey flood flows into the canal. Such additional levees would continue up the tributary streams to the limit of the backwater influence of the main flood channel. Drainage water from the areas protected by these levees would be conveyed into the Colusa Basin Drainage Canal either by gravity or by pumps. Facilities for drainage from areas lying outside the present flood plain would not be included as part of the levee projects.

The Colusa Basin Levee Projects would provide flood protection to Reaches 2, 3, 4, and 5, but would not extend into Reach 1. Within design limits, therefore, they would protect lands in the basin presently subject to flooding. The largest levee system--the Two Percent Project^{1/}-- would provide protection from project design floods reaching a magnitude of 27,000 second-feet as measured at the Highway 20 Bridge near Colusa. Smaller levee systems, the Five Percent and Ten Percent Projects, would provide protection from project design floods reaching magnitudes of

^{1/} The term "two percent" refers to the size of flood that would be equalled or exceeded two percent of the time or an average of once-in-50-years. Similarly, a five percent flood would be equalled or exceeded once-in-20-years; and a ten percent flood, once-in-10-years.

22,000 and 15,300 second-feet, respectively, at the same point. Because the projects would confine flood waters to the leveed channels and prevent temporary storage on flooded areas, project design flood discharges would be greater than pre-project flood discharges.

Each size of levee project would comprise 142 miles of new levee construction. In the southern portion of the area, between Knights Landing and a point 4 miles south of Colusa, the existing back levee of Reclamation District No. 108, which is part of the Sacramento River Flood Control Project, would constitute the east levee of each of the Colusa Basin Levee Projects. Only the west levee would be new along this stretch. To allow for the passage of project design floods, the west levee for its entire length would be placed some distance from the Colusa Basin Drainage Canal. Proposed flood channel widths of about 1,000 feet in the southern part of the project may be compared with the present drainage channel width of about 200 feet.

Table 9 shows the channel width and design discharge at various points for each of the three projects. Plate 5, "Profile and Typical Sections of Colusa Basin Levee Projects," shows typical cross sections and water surface profiles of the three projects. Levee and channel design standards conform to those of the U. S. Corps of Engineers, Sacramento District.

The levees would vary in height from about 18 feet in the south to 11 feet in the north and would provide 3 feet of freeboard at design flood stage. The levee embankment would be constructed with side slopes of 3 to 1 on the waterside and 2 to 1 on the landside. A berm 20 feet wide was provided between the waterside toe of the levee and the edge of the low water channel. From the southern terminus of the system at Knights Landing Ridge Cut north to Highway 20 near Colusa, levees along the Colusa Basin

TABLE 9

CHANNEL WIDTHS AND DESIGN DISCHARGES
FOR COLUSA BASIN LEVEE PROJECTS

Location	Station, in feet	Two Percent Project		Five Percent Project		Ten Percent Project	
		Discharge in second-feet	Channel:With flood:Without flood	retention	width,Discharge, in	second-feet	Channel:
	in feet	reservoir	reservoir*	in feet	second-feet	in feet	second-feet
<u>Willow Creek</u>							
at Glenn-Colusa Irrigation District Canal crossing near Willows	3,403 + 00	450	17,000	17,000	350	13,200	275 10,500
at Glenn-Colusa County line	3,000 + 00	450	17,000	17,000	350	13,200	275 10,500
<u>Colusa Basin Drainage Canal</u>							
above Maxwell Road	2,300 + 00	700	21,000	21,000	650	17,600	500 13,300
below Maxwell Road	2,200 + 00	700	16,000	25,000	700	21,000	500 15,000
at Highway 20 Bridge near Colusa	1,982 + 00	775	18,000	27,000	950	22,000	650 15,300
at Wallace Crossing	1,558 + 00	775	18,000	27,000	950	22,000	650 15,300
at Hilgate-Tule Road near College City	1,232 + 00	850	22,000	29,000	950	23,000	700 16,800
at Colusa-Yolo County line	827 + 00	850	22,000	30,000	950	23,000	700 16,800
at Knights Landing	0 + 00	1,000	26,000	34,000	1,000	24,000	800 18,300

*These figures represent flow that would occur without 16,000 acre-feet of storage in a flood retention reservoir which would be a part of this project.

Drainage Canal would have a crown width of 20 feet. Further north and along all tributary channels, their crown width would be 12 feet.

The new levees of any of the three Colusa Basin Levee Projects would block drainage from the lands that the levees would protect. New drainage facilities would be required to remove water from the protected areas. Such facilities would consist of improved farm drainage works, collector drains, and pumping plants. Construction of improved farm drainage works would be the responsibility of individual landowners. The farm drains would convey water to project-built collector drains, 6 to 8 feet deep, which, in turn, would carry the water into the Colusa Basin Drainage Canal. Project-built pumping plants would pump water from the collector drains into the canal during its high water periods. During low water periods, water from the collector drains would flow directly into the canal.

The largest of the Colusa Basin Levee Projects, the Two Percent Project, would include a flood retention reservoir just north of Maxwell Road at the confluence of Stone Corral Creek and the drainage canal. Two miles of low dike on its perimeter, as well as a portion of the new levee, would confine the reservoir to 2,100 acres. The reservoir would have a storage capacity of 16,000 acre-feet. Whenever discharge near Colusa would exceed 20,000 second-feet, a specially designed concrete weir in the main levee would permit excess flows from the drainage channel to enter the flood retention reservoir. By reducing the peaks of the very large floods, this reservoir would allow the use, in the lower portion of the project area, of a smaller flood channel than would otherwise be possible for the same level of flood protection.

The Two Percent Project would protect about 80,000 acres of Colusa Basin lands which have flooded in recent years. The project would handle

floods whose magnitude, without the flood retention reservoir, would be 27,000 second-feet as measured at Highway 20 Bridge near Colusa. A comparable flood under present conditions would discharge about 25,000 second-feet at Highway 20. Under present conditions, the flow is decreased somewhat by storage in flooded areas, whereas under project conditions the entire flood runoff would be channelized. The flood retention reservoir would reduce floods of this magnitude to 18,000 second-feet at Highway 20. Project design would provide complete protection from the once-in-50-year flood and would reduce the acreage affected by larger floods.

The Five Percent Project would have a design capacity of 22,000 second-feet as measured at the Highway 20 Bridge. A flood of this size, occurring under present conditions, would discharge about 18,000 second-feet at Highway 20. Project design for this flood was based upon complete channelization of the flows without a retention reservoir. Complete protection would be afforded to lands subject to overflow from the Colusa Basin Drainage Canal for floods up to the design capacity. This capacity approximates a flood with a probability of once-in-20-year occurrence, or about the size of that which occurred in February 1942.

The Ten Percent Project would have a design capacity of 15,300 second-feet, measured at the Highway 20 Bridge. A flood of this size, occurring under present conditions, would discharge about 11,000 second-feet at Highway 20. Project design would provide complete protection to lands subject to overflow from the Colusa Basin Drainage Canal from floods up to the magnitude of a once-in-10-year flood. This size may be compared to a flood smaller than that of February 1942, but larger than that of March 1949.

Estimated Costs

The estimated capital cost of each project includes costs of construction, costs of acquiring flood easements and rights-of-way, and costs of relocating public and private utilities. Capital costs were based on unit construction prices prevailing in the spring of 1961. Capital costs include allowances for contingencies, engineering and administration. Capital costs also include allowances for interest during construction at the rate of four percent a year for one-half the construction period.

Annual costs include costs of replacement, operation, maintenance, and general expense. They include interest on the capital investment and repayment over a 50-year period at either 4 or 2-5/8 percent a year. The four percent rate is assumed to be applicable to construction by a local public agency; the 2-5/8 percent rate, to construction by an agency of the United States.

Table 10 shows the estimated capital cost of each of the Colusa Basin Levee Projects, and Table 11, the estimated annual cost of each.

Project Benefits

The three projects would provide complete protection from floods whose pre-project magnitudes would reach 25,000, 18,000, and 11,000 second-feet, respectively, as measured in the Colusa Basin Drainage Canal at Highway 20 Bridge near Colusa. Floods of this magnitude represent the once-in-50-year flood, the once-in-20 year flood, and the once-in-10 year flood.

Flood discharges greater than those for which each project was designed would continue to flood Colusa Basin lands, but to a reduced extent. In general, proposed levees west of the main flood channel would be lower than those on the east. Overtopping the west levees would not cause general

TABLE 10

ESTIMATED CAPITAL COSTS OF
COLUSA BASIN LEVEE PROJECTS
(In dollars)

Item	: Two Percent : Project	: Five Percent : Project	: Ten Percent : Project
<u>Construction items</u>			
<u>Embankment</u>			
Main channel	6,958,000	6,131,000	5,480,000
Tributary channels	1,464,000	1,487,000	1,273,000
Road approaches	144,000	143,000	140,000
Patrol roads	794,000	785,000	775,000
Clearing and grubbing	215,000	216,000	172,000
Drainage channel excavation	316,000	316,000	316,000
Drainage pumping plants	5,389,000	4,390,000	3,635,000
<u>Lands and Damages</u>			
Levee rights-of-way	392,000	358,000	348,000
Main channel	308,000	326,000	303,000
Tributary channels			
Flood easements	915,000	945,000	630,000
Main channel	104,000	0	0
Flood retention reservoir	516,000	488,000	384,000
Acquisition costs (30%)			
<u>Relocations</u>			
Bridges and roads	1,163,000	1,093,000	848,000
Irrigation and drainage structures	528,000	516,000	516,000
Power and telephone lines	100,000	100,000	100,000
Gates	29,000	28,000	28,000
Subtotal	<u>19,335,000</u>	<u>17,322,000</u>	<u>14,948,000</u>
Contingencies (20%)	3,867,000	3,464,000	2,989,000
Engineering and administration (10%)	2,321,000	2,078,000	1,794,000
Interest during construction (4%)	510,000	458,000	395,000
Total capital costs	<u>26,033,000</u>	<u>23,322,000</u>	<u>20,126,000</u>

TABLE 11

ESTIMATED ANNUAL COSTS OF
COLUSA BASIN LEVEE PROJECTS
(In dollars)

Item	Two Percent		Five Percent		Ten Percent	
	Project	Interest	Project	Interest	Project	Interest
Interest	1,101,000	683,000	933,000	612,000	805,000	528,000
Repayment	171,000	258,000	153,000	231,000	132,000	199,000
Replacement	64,000	64,000	52,000	52,000	40,000	40,000
Operation and maintenance (Including electric energy for pumping)	435,000	435,000	411,000	411,000	388,000	388,000
Total annual costs	1,771,000	1,440,000	1,549,000	1,306,000	1,365,000	1,155,000

flooding because flood waters then would be confined to the area between the levees along tributary streams at the north and south ends of the area affected. The effect of such overtopping would be to reduce the flood stage in the main flood channel and to lessen the flood hazard to areas downstream.

The comparison of estimated flood damage to Colusa Basin land before and after construction of each of the Colusa Basin Levee Projects permitted the evaluation of the accomplishments of each project. The effect on each of the projects of flood sizes exceeding project design floods was calculated in terms of the extent of area which would be flooded. Statistical analysis of areas subject to flooding enabled the preparation of graphs showing the probability of occurrence of various sizes of floods and the extent of the area flooded by each size under project conditions. The method of analysis was similar to that used to determine probability of occurrence under pre-project conditions. The graphs in Figure 8 depict conditions of flooding in Reaches 2, 3, 4, and 5 with and without the Colusa Basin Levee Projects.

Average annual primary benefits directly attributable to the Colusa Basin Levee Projects result from reductions in crop and miscellaneous damages as well as from enhancement to agricultural and urban lands in the four reaches included in the project. Table 12 itemizes these benefits. A discussion follows of the methods by which such benefits were computed.

Crop Damage Reductions. A method similar to that discussed in Chapter III to determine average annual equivalent crop damage without a project was used to compute such damage under project conditions. The method utilized data developed from the relationship between crop damage in Reaches 2, 3, 4, and 5 and the probability of annual occurrence of

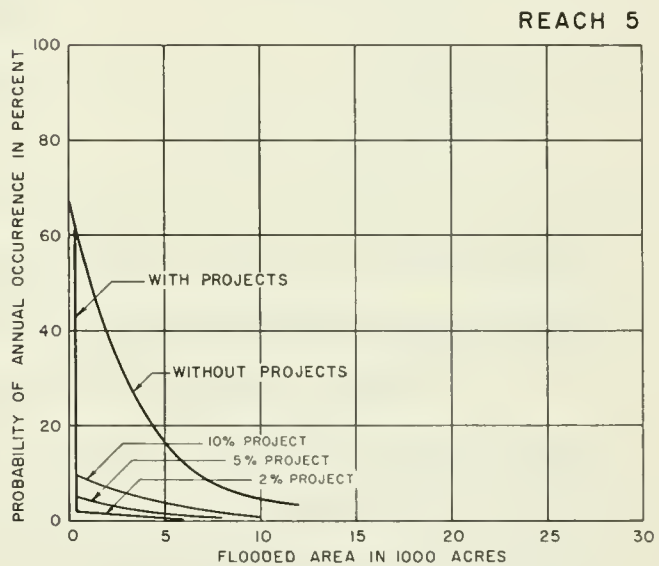
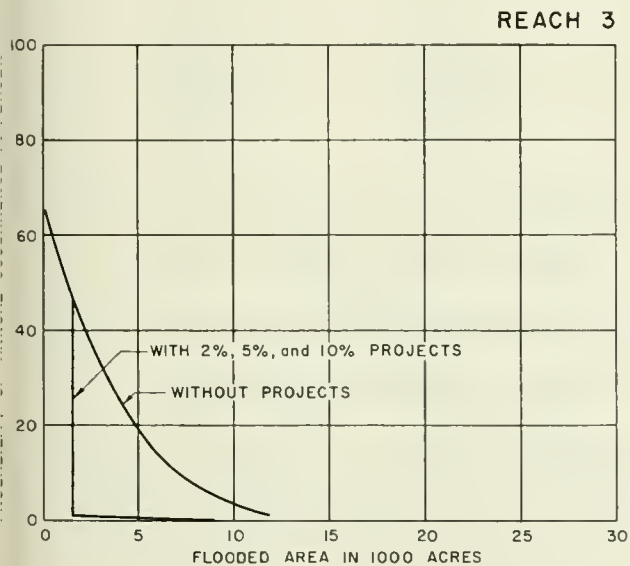
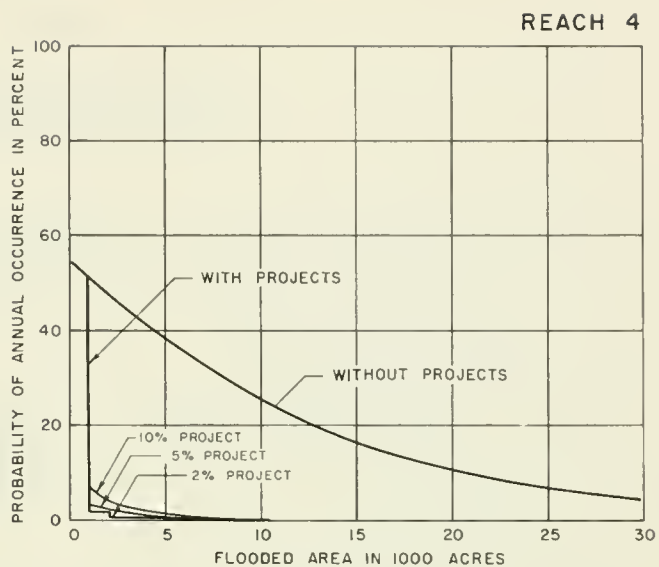
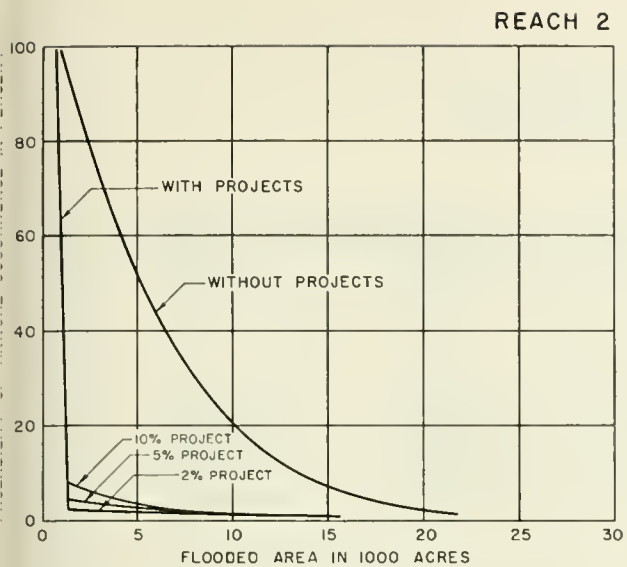

REACH	LOCATION
2	KNIGHTS LANDING TO COLLEGE CITY
3	COLLEGE CITY TO HIGHWAY 20
4	HIGHWAY 20 TO COLUSA-GLENN COUNTY LINE
5	COLUSA-GLENN COUNTY LINE TO WILLOWS

Figure 8. PROBABILITY OF FLOODING IN COLUSA BASIN WITH AND WITHOUT THE COLUSA BASIN LEVEE PROJECTS

TABLE 12

ESTIMATED ANNUAL BENEFITS
OF COLUSA BASIN LEVEE PROJECTS
(In dollars)

Type of benefit	: Two Percent : Project	: Five Percent : Project	: Ten Percent : Project
<u>Damage prevention</u>			
Crop damage	144,000	139,000	134,000
Miscellaneous damage	<u>44,000</u>	<u>43,000</u>	<u>42,000</u>
Subtotal	188,000	182,000	176,000
<u>Land enhancement</u>			
Agricultural	368,000	368,000	368,000
Urban	<u>22,000</u>	<u>0</u>	<u>0</u>
Subtotal	<u>390,000</u>	<u>368,000</u>	<u>368,000</u>
Total annual benefits	578,000	550,000	544,000

various sizes of floods in these reaches. This relationship is shown in Figure 9 under conditions with and without the Colusa Basin Levee Projects.

Without a project, the average annual equivalent crop damage would amount of \$150,000; with the Two Percent Project, such damage would amount to only \$6,000. The annual amount of damages reduced by the project, \$144,000, represents the average annual crop damage prevention benefits of the Two Percent Project. Similarly, average annual crop damage prevention benefits for the Five Percent and Ten Percent Projects were estimated to be \$139,000 and \$134,000, respectively.

Miscellaneous Damage Reductions. A method similar to that developed in Chapter III to determine average annual miscellaneous damages without a project was used to compute such damages under project conditions.

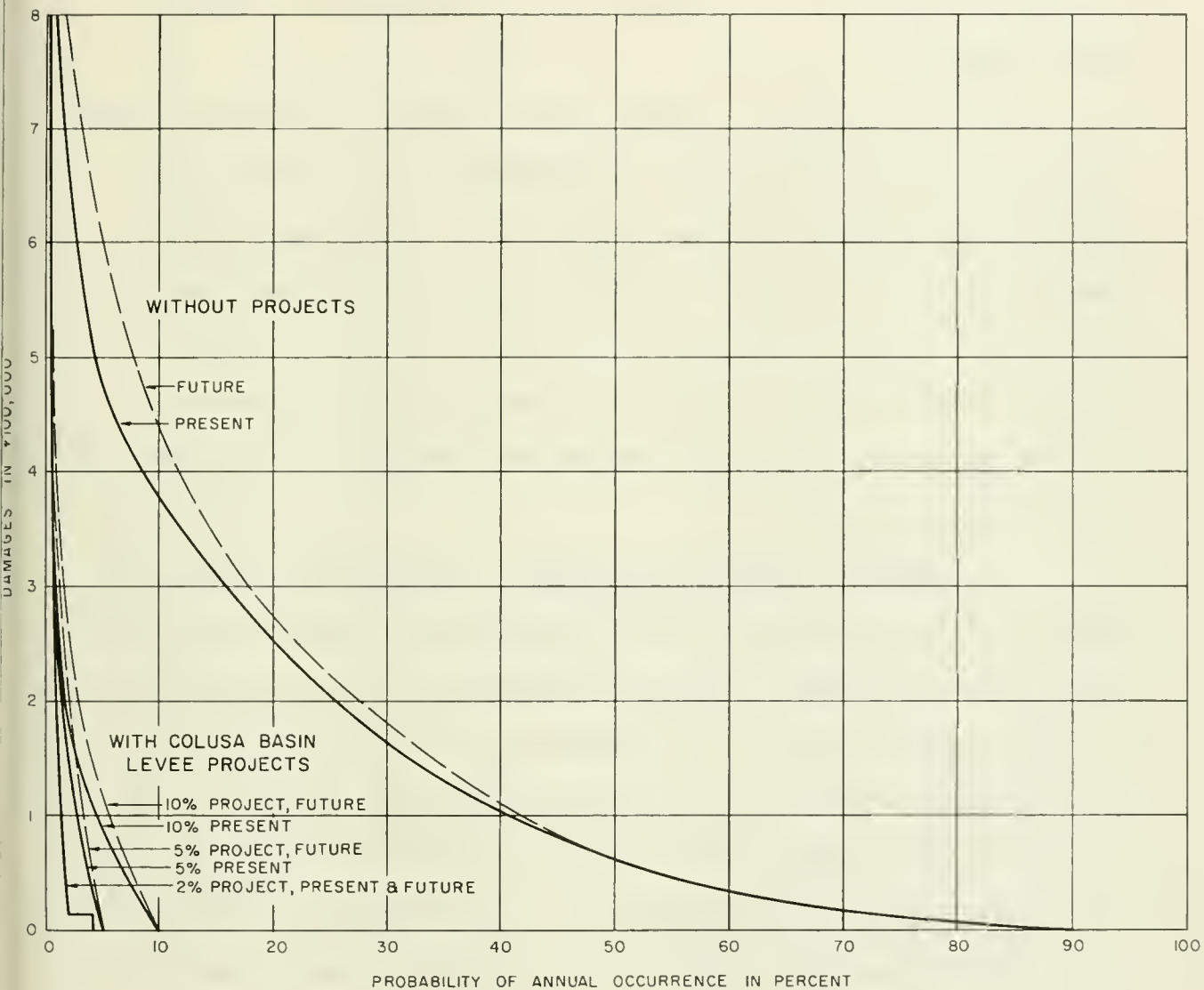

Figure 9. PROBABILITY OF CROP DAMAGES IN REACHES 2, 3, 4, AND 5 WITH AND WITHOUT COLUSA BASIN LEVEE PROJECTS

The method utilized data developed from the relationship between miscellaneous damage in Reaches 2, 3, 4, and 5 and the probability of annual occurrence of various sizes of floods in these reaches. This relationship is shown in Figure 10 under conditions with and without the Colusa Basin Levee Projects.

Under existing conditions, without a project, the average annual miscellaneous damage was estimated to be \$46,000; with the Two Percent Project, such damage would amount to only \$2,000. The annual amount of damage reduced by the project, \$44,000, represents the average annual miscellaneous damage prevention benefits of the Two Percent Project. Similarly, average annual miscellaneous damage prevention benefits for the Five Percent and Ten Percent Projects were estimated to be \$43,000 and \$42,000, respectively.

Enhancement to Agricultural Lands. Significant benefits would result from the possibility of a more intensive use of agricultural lands under project conditions. The future crop pattern would include more of the higher paying truck and field crops and the use of lands now idle would increase the total crop area. Such benefits were measured as the difference between returns to the land with and without each of the Colusa Basin Levee Projects. The average annual benefit from more intensive use of agricultural lands was estimated to be \$368,000 for each of the levee projects in the four reaches affected by the project.

Enhancement to Urban Lands. Under the level of flood protection afforded by the Two Percent Levee Project about 1,500 additional acres in the Colusa Basin would be subject to urban development. This amount includes about 800 acres near Willows, 120 acres at Delevan, 300 acres at

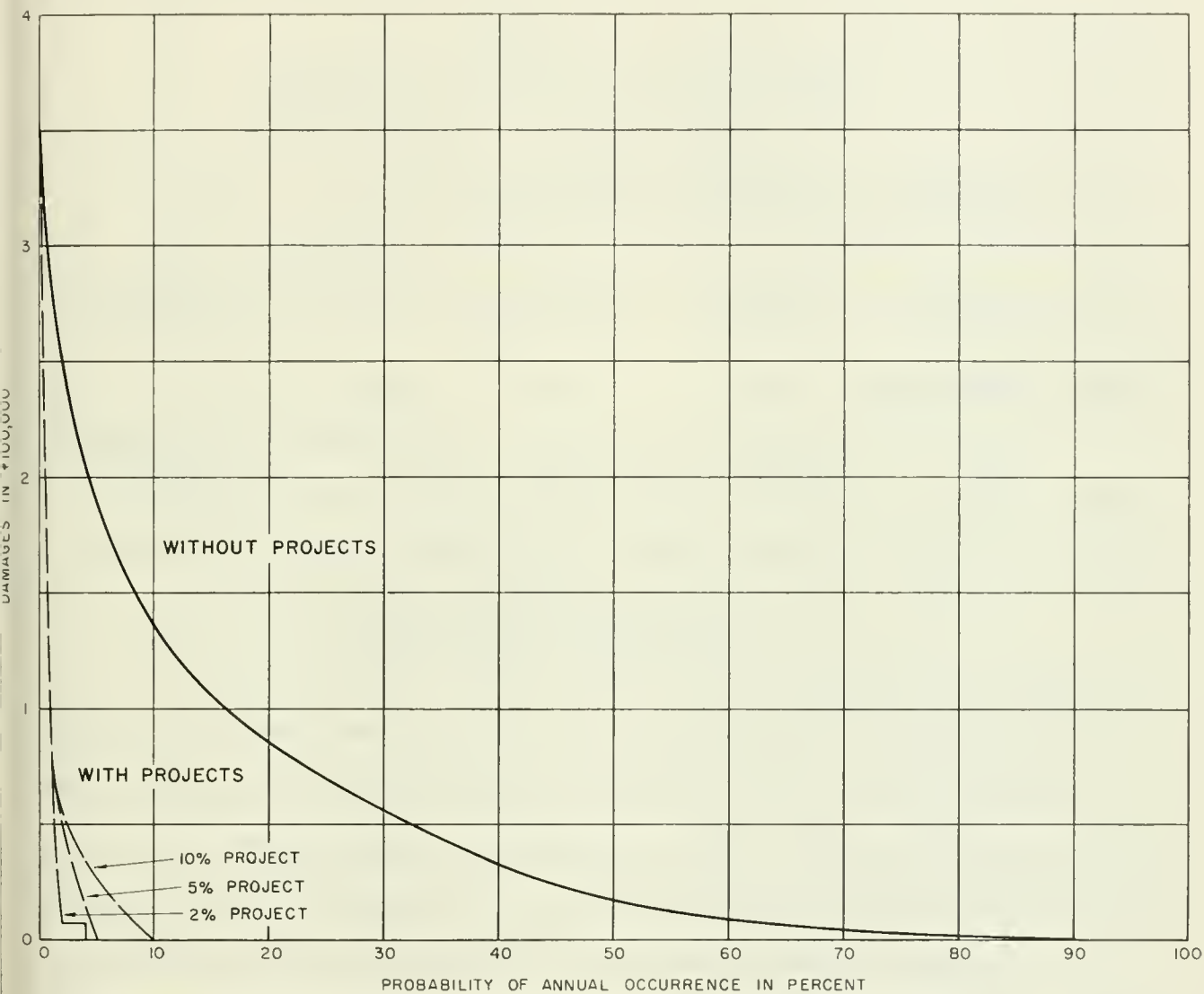

Figure 10. PROBABILITY OF MISCELLANEOUS DAMAGES
 IN REACHES 2, 3, 4, AND 5
 WITH AND WITHOUT COLUSA BASIN LEVEE PROJECTS

Colusa, and 320 acres at Knights Landing. Such an increase in habitable areas protected from floods is a project benefit.

Assuming progressive urban development of these lands throughout a 50-year period, the average annual urban benefit for the four reaches affected by the Two Percent Project was estimated to be \$22,000. This benefit was based on the increase in returns to the land measured at five percent per year of the increased capital value of the land. The two projects of lesser protection would afford insufficient protection to induce urban land use and consequently, no enhancement benefits would be derived.

Economic Justification

Before a public agency can consider construction of a flood control project, that project must be economically justified. To be economically justified, a project must have primary benefits which exceed project costs.

The primary benefits from any of the Colusa Basin Levee Projects do not exceed the respective costs of each project. Table 13 shows this to be the case whether the interest rate is that assumed applicable to construction by a local public agency or that assumed applicable to construction by an agency of the United States. For the present level of development in the Colusa Basin, therefore, a levee project would not be economically justified.

A complete economic analysis would require a determination of the benefits or detriments accruing to the project as a result of its effect on fish and game. Wildlife studies were conducted during this investigation only at a reconnaissance level to determine the usage of land within the historically flooded area for migratory waterfowl habitat. From this brief survey it was assumed that construction of a flood control and drainage project in the Colusa Basin would adversely affect waterfowl habitat. A

detailed determination of possible detriments, or benefits, was omitted because the project was shown to be not justified on the basis of primary agricultural and urban benefits.

TABLE 13

COMPARISON OF ESTIMATED COSTS AND BENEFITS
OF COLUSA BASIN LEVEE PROJECTS

Item	: Two Percent : Project	: Five Percent : Project	: Ten Percent : Project
<u>Annual costs, in dollars</u>			
4% interest	1,771,000	1,549,000	1,365,000
2-5/8% interest	1,440,000	1,306,000	1,155,000
<u>Annual benefits, in dollars</u>	578,000	550,000	544,000
<u>Benefit-cost ratio</u>			
4% interest	0.33	0.36	0.40
2-5/8% interest	0.40	0.42	0.47

Foothill Reservoir Project

The area contributing flood runoff to the Colusa Basin Drainage Canal covers about 1,500 square miles. Of this area, 570 square miles comprise the tributary watershed in the eastern foothills of the Coast Range and the remaining 930 square miles lie within the relatively flat Sacramento Valley. During major storms in this drainage area, more precipitation falls in the foothills than in the valley. Dams constructed across the streams of this foothill watershed would create reservoirs whose temporary storage of flood runoff would reduce flood discharge in the Colusa Basin Drainage Canal. An investigation was made to determine the degree of flood control that a series of reservoirs would provide.

Control of the entire watershed would require dams on 67 streams. However, dams on 17 of the larger streams would control a watershed of

480 square miles, about 80 percent of the foothill drainage area. These 17 dams are described in this section as the Foothill Reservoir Project. A reconnaissance engineering survey was made to determine the cost of the project and the degree of protection it would provide.

The Foothill Reservoir Project was designed to control floods with a probability of occurrence of two percent, or floods whose magnitude is that of the once-in-50-year flood. Flood hydrographs and the magnitude of flood flows at the reservoir sites were developed from data used to determine the contribution of the tributary streams to flood flows in the Colusa Basin Drainage Canal. The storage capacity of each reservoir was selected for purposes of flood control only and without consideration of water conservation or other purposes. Reservoir capacity at each site would be sufficient to store runoff without outflow for the duration of high flood inflows to the reservoir. Outlet works were designed to release the stored water rapidly so that each reservoir would empty and be ready to control the next flood peak occurring on the tributary. Releases would not be permitted to exceed the capacities of downstream channels, and would be timed to enter the Colusa Basin Drainage Canal after the peak flood flow in the canal had passed well downstream.

Preliminary designs and cost estimates were prepared for each of the 17 dams and reservoirs with consideration given to the geology of the site, the availability of construction materials and engineering standards for the safety and operation of the project. The total capital cost of the Foothill Reservoir Project was estimated to be about \$28,760,000. For each dam and reservoir, Table 14 gives the capital cost, drainage area, storage capacity, and flood discharge under conditions of the once-in-50-year flood. Tables 15 and 16 show probable conditions during a once-in-50-year

TABLE 14

SUMMARY OF FOOTHILL RESERVOIR PROJECT

Reservoir location	Drainage	Reservoir	Once-in-50-year		Capital
	area above dam site, in square miles	storage capacity, in acre-feet	flood discharge, in second-feet		costs of dam and reservoir, in dollars
			Uncontrolled	Controlled ^{1/}	
Wilson Creek	13.5	2,200)			1,305,000
French Creek	69.2	11,000)			3,865,000
Unnamed Creek	13.7	2,200)	16,400	3,500	1,619,000
South Fork Willow Creek	79.0	12,600)			2,452,000
Logan Creek	20.4	3,300)			888,000
Hunter Creek	15.8	2,500)	3,900	550	1,088,000
Funks Creek	47.5	7,600)			1,516,000
Stone Corral Creek	36.5	5,800)	8,300	900	1,317,000
Freshwater Creek	32.8	7,000)			1,414,000
Salt Creek	10.5	2/)	4,300	540	392,000
Spring Creek	16.9	2,700	1,700	200	2,205,000
Cortina Creek	33.5	5,300	3,400	450	2,760,000
Salt Creek	18.9	3,000	1,900	250	2,082,000
Petroleum Creek	6.0	1,000	600	60	1,212,000
Buckeye Creek	31.3	5,000	3,100	350	2,200,000
Bird Creek	8.0	1,300	800	150	1,040,000
Oak Creek	<u>27.0</u>	<u>4,300</u>	<u>2,700</u>	<u>350</u>	<u>1,405,000</u>
	480.5	76,800	-----	-----	28,760,000

^{1/} Controlled release following flood. No releases made during high flood inflow.

^{2/} Salt Creek Dam diverts up to 1,000 second-feet into Freshwater Creek Reservoir.

TABLE 15

PROBABLE DISCHARGE IN WILLOW CREEK AND THE COLUSA BASIN
DRAINAGE CANAL DURING A ONCE-IN-50-YEAR FLOOD

(In second-feet)			
Location	: With : Foothill : Reservoir : Project	: With : Two Percent : Colusa Basin : Levee Project ^{1/}	: Without : either : project
<u>Willow Creek</u>			
at Glenn-Colusa Irriga- tion District Canal crossing near Willows	6,200	17,000	--
<u>Colusa Basin Drainage Canal</u>			
at Highway 20 Bridge near Colusa	9,600	27,000	23,900 ^{2/}
at Knights Landing	13,200	34,000	--
^{1/} Without flood retention reservoir			
^{2/} Maximum mean daily flow, 1958			

TABLE 16

PROBABLE FLOODED AREAS IN REACHES 2, 3, 4, 5, and 6
DURING A ONCE-IN-50-YEAR FLOOD

(In acres)			
Reach	: With : Foothill : Reservoir : Project	: With : Two Percent : Colusa Basin : Levee Project	: Without : either : project
6 - Northwest of Willows	0	17,500*	17,500
5 - Willows to Glenn-Colusa county line	6,500	0	15,000
4 - Glenn-Colusa county line to Highway 20	19,000	0	40,000
3 - Highway 20 to College City	5,800	0	10,600
2 - College City to Knights Landing	<u>17,000</u>	<u>0</u>	<u>21,000</u>
	48,300	17,500	104,100

* Levee project does not extend into Reach 6.

flood with and without either the Foothill Reservoir Project or the Two Percent Colusa Basin Levee Project. Table 15 shows probable conditions in terms of discharge in Willow Creek and the Colusa Basin Drainage Canal. Table 16 shows the probable flooded areas in Reaches 2 through 6. Reach 6 was not included within the area to be protected by the Colusa Basin Levee Project.

The accomplishments of the Foothill Reservoir Project may be evaluated by comparing the degree of flooding expected under project conditions to that which would occur both under pre-project conditions and under conditions which would be created by the Two Percent Colusa Basin Levee Project.

During a flood of the once-in-50-year magnitude, the most favorable operation of the foothill reservoirs would reduce the peak flow in the Colusa Basin Drainage Canal to 9,600 second-feet at the Highway 20 Bridge. Under pre-project conditions during a flood of the same magnitude, discharge at the same point would have been 25,000 second-feet. Correspondingly, operation of the foothill reservoirs would reduce to 48,300 acres a flooded area which under pre-project conditions would have been 104,100 acres.

During a flood of once-in-50-year magnitude, the Two Percent Colusa Basin Levee Project would completely alleviate flooding in Reaches 2, 3, 4, and 5 of the Colusa Basin, whereas, the Foothill Reservoir Project would allow flooding of 48,300 acres in those reaches. However, flooding of 17,500 acres in Reach 6 north of Willows would be prevented by the reservoir project but not by the levee project.

An evaluation of the economic justification of the Foothill Reservoir Project would require that project costs be compared to project benefits as computed by determination of the reduction in flood damages

in the area protected by the project. Because it can be seen by comparing flooded areas that the benefits from the Foothill Reservoir Project would not be as great as those from the Two Percent Project, this computation was not made. For the Foothill Reservoir Project to provide the same degree of protection as that provided by the Two Percent Project, a system of low levees along the Colusa Basin Drainage Canal would have to be built. This additional construction would raise the cost of the reservoir project considerably above that of the Two Percent Project. Furthermore, despite the greater benefits and the lower cost of the Two Percent Project, the Two Percent Project has been shown not to be economically justified. It may be concluded, therefore, that the Foothill Reservoir Project also is not economically justified.

Watershed Management

Runoff from a watershed, measured as the difference between precipitation and infiltration, is influenced greatly by the retentive characteristics of the watershed. If the infiltration rate can be increased by watershed management, the amount of runoff contributed to downstream flood flows can be reduced.

Runoff from the foothill drainage area makes the major contribution to flood flows occurring in the Colusa Basin. Detailed analyses of a number of small-to-medium storms experienced in this area indicate that for a given storm the soil absorbs a large quantity of water before any runoff occurs. This absorption is called the initial loss. As the soil becomes saturated, the infiltration rate decreases and becomes quite low. The average infiltration rate in the foothill drainage area for the ten hours after initial loss was estimated to be 0.05 inches an hour.

The "Hydrology Handbook," prepared by the Committee on Hydrology of the Hydraulics Division of the American Society of Civil Engineers, and adopted January 17, 1949, cites studies which indicate that such an infiltration rate can be increased two to three times by improvement of the watershed. Watershed management experiments in similar foothill regions show that the infiltration rate can be increased considerably by improving the grass cover, by converting chaparral areas to grass covered areas, and by improving grazing practices.

It can be estimated that if the foothill drainage area infiltration rate of 0.05 inches an hour were doubled within a 25-square mile area in the foothill watershed, the reduction in runoff from that area could be as great as 800 second-feet. Were watershed management to duplicate such reductions in runoff throughout the foothill drainage area, flood discharge through the Colusa Basin Drainage Canal would be greatly reduced. The reduction in flood discharge would not equal the sum of the reductions in runoff effected by watershed management because the runoff from various tributary watersheds would reach the drainage canal at different times. The effectiveness of watershed management for the purpose of flood control would be lessened during extended periods of rainfall or in repeated storms.

Because of limitations of time and funds, field studies of watershed management practices were not made as part of this investigation. Such studies would be of great value to future evaluations. Much time and experimental work would be required before conclusive results could be reached. These results might well indicate a relatively inexpensive method of reducing flood discharge. Such a method, however, would have to be coupled with some levee works in the valley area to provide flood protection comparable

to that provided by the levee projects previously discussed. Adequate control of flood waters by watershed management only is considered highly improbable.

Yolo Bypass Project

The Yolo Bypass Project would improve existing drainage facilities within the Yolo Bypass. The project is designed to alleviate springtime crop and miscellaneous damages caused principally by irrigation return flows flooding Reaches 2 and 1. Reach 2 extends along the Colusa Basin Drainage Canal from College City to Knights Landing. Reach 1, within the northern Yolo Bypass, extends southward from the mouth of the Knights Landing Ridge Cut to the Sacramento Deep Water Ship Channel.

In the spring, high water in the Sacramento River prevents irrigation return flows from passing through the Knights Landing outfall gates into the river. At the same time, the inadequate outlet at the downstream end of the Knights Landing Ridge Cut impedes water passing through the ridge cut into the Yolo Bypass. Before the water reaches an elevation sufficient to discharge into the bypass, it has flooded lands in Reach 2. Water passing through the ridge cut into the bypass causes additional damage by flooding early plantings in the bypass farm lands of Reach 1.

The Yolo Bypass Project would correct this situation with a new channel from the downstream end of the ridge cut. Under conditions of no flow in the Yolo Bypass, drainage facilities of the project would prevent flooding of farm lands in Reaches 1 and 2 when discharges from the ridge cut did not exceed 2,000 second-feet. During floods in excess of this design capacity, flooding in Reaches 1 and 2 would be reduced both in extent and duration.

From October 1 through March 31, the drainage facilities of the Yolo Bypass Project would have only very limited effect because the Yolo Bypass usually would be carrying winter flood waters from the Sacramento River at the same time that runoff from the Colusa Basin would be high. Although project facilities are not designed specifically to function under such conditions, they would provide some relief from flooding in Reach 2 at times when flows through the bypass were relatively small.

The drainage facilities provided by the Yolo Bypass Project would include: (1) a check structure at the downstream end of the Knights Landing Ridge Cut; (2) a new channel across the Yolo Bypass from Knights Landing Ridge Cut to the Tule Canal; (3) an enlarged Tule Canal; and (4) a check structure near the downstream end of the enlarged Tule Canal. Plate 6, "Profile, Plan and Typical Sections of Yolo Bypass Project," shows these facilities.

Check Structure (No. 1)

A check structure of reinforced concrete would be built at the ridge cut entrance to the new channel. Incorporated into the design of this check structure would be a transition section between the Knights Landing Ridge Cut and the new channel across the bypass. The structure would be divided into bays for stop logs. These features would control the discharge within permissible velocities, and would maintain the water surface elevations required for irrigation. The check structure would not infringe upon the existing capacity of the ridge cut for the discharge of winter flood flows.

New Channel

The new 10,000 foot long channel across the Yolo Bypass would extend from the mouth of the Knights Landing Ridge Cut to the Tule Canal.

It would be unlined and would have side slopes of 3 to 1, an average depth of 10 feet, and a bottom width of 70 feet. The bottom of the new channel would slope from an elevation of 11 feet at the west end to 7 feet at the east end (USGS datum). The design capacity of the new channel would be 2,000 second-feet. Channel construction would require the acquisition of an estimated 60 acres of land. This acreage would be sufficient to provide for the channel as well as for alternative methods for disposal of an estimated 431,000 cubic yards of excavated material. The actual method of disposal should be determined prior to project construction. Some of this material might prove to be soil of a quality satisfactory for farming purposes; the possibility exists that such soil might be spread out so that the disposal area could be farmed. In the event of actual construction, the State Reclamation Board would have to approve the depth and configuration of proposed spoil areas.

Enlarged Tule Canal

The Tule Canal is situated adjacent to the east levee of the Yolo Bypass and is utilized for both irrigation and drainage. The enlarged Tule Canal would carry flows from the proposed new channel to the upper end of the toe drain of the Sacramento Deep Water Ship Channel. For practical purposes, the capacity of the toe drain at this point, 2,400 second-feet, governs the hydraulic design of the Yolo Bypass Project. Therefore, the 2,400 second-foot capacity of the enlarged Tule Canal at the point where it enters the toe drain would be 400 second-feet greater than the capacity of the new channel across the Yolo Bypass. This greater downstream capacity provides for drainage water to enter the Tule Canal from lands farmed in the Yolo Bypass. Existing rights-of-way held by the



View of Tule Canal looking southward showing restricted channel capacity above Highway 40 crossing. Sacramento Deep Water Ship Channel and toe drain can be seen in background.



View of the Tule Canal looking northward showing Sacramento Bypass entering Yolo Bypass from the right side of photograph, and the much restricted channel of the Tule Canal.

Sacramento and San Joaquin Drainage District should be sufficient for the work required along the Tule Canal. These rights-of-way are under the jurisdiction of the State Reclamation Board.

Tule Canal would be enlarged by excavating 225,400 cubic yards from 3,800 lineal feet of a narrow section of the canal between the Sacramento Bypass and Highway 40. Some brush and trees would have to be removed. The enlarged canal would have side slopes of 3 to 1, and a bottom width of 70 feet. The elevation (USGS datum) of the bottom of the canal would be at sea level at the intersection of the Sacramento Bypass and 1 foot below sea level at the intersection of the Southern Pacific Railroad bridge.

In addition to the required excavation, small levees will be required at several locations to maintain the design water surface in the Tule Canal from its junction with the new channel to the toe drain of the ship channel. Plate 6 shows the locations of these levees. The required levees will total 15,300 lineal feet in length. Their construction along the Tule Canal will require 30,500 cubic yards of embankment material. The maximum height of these levees including 1 foot of freeboard, would be 4.5 feet. It was assumed that their side slopes would be 3 to 1 and that their crown width would be 12 feet. That portion of the levee across the mouth of the Sacramento Bypass would have a maximum height of 2 feet. To minimize the obstruction to flood flows entering the Yolo Bypass from the Sacramento Bypass, the freeboard at this point would be reduced to one-half foot. This is the freeboard provided by the west levee of the toe drain of the Sacramento Deep Water Ship Channel.

The enlargement of the Tule Canal and the construction of the low levees would require relocation of certain existing drainage facilities

in this area of the Yolo Bypass. At some points, the new levees would interfere with existing irrigation pumping facilities and these facilities also would require relocation. The preliminary designs made for these relocations would be subject to review during final design stages should this project be constructed.

Check Structure (No. 2)

A check structure similar to that proposed for the downstream end of the Knights Landing Ridge Cut would be built near an existing check structure located about 4,000 feet north of Highway 40. The proposed check structure would maintain water elevations at present levels in the Tule Canal during the irrigation season.

Estimated Costs

Based upon construction prices prevailing in 1961, the estimated total capital cost of the Yolo Bypass Project would be \$586,000. Levee construction and canal excavation, including the removal of brush and trees, comprises \$317,000 of the cost. The acquisition of rights-of-way and relocation of existing structures comprises the remaining \$269,000. The amount estimated for rights-of-way would be subject to minor change depending upon the method used to dispose of the material excavated from the new channel across the Yolo Bypass.

The total annual cost of the project would be \$41,200, with financing at an interest rate of four percent a year.

A summary of capital and annual costs of the Yolo Bypass Project is presented in Table 17.

TABLE 17
ESTIMATED CAPITAL AND ANNUAL COSTS
OF YOLO BYPASS PROJECT

(In dollars)

Item	Costs
<u>CAPITAL COSTS</u>	
<u>Construction items</u>	
Embankment	\$ 18,300
Excavation	
New channel	129,500
Enlarged Tule Canal	90,200
<u>Lands and damages</u>	
Rights-of-way	15,000
Acquisition costs (30%)	4,500
<u>Relocations</u>	
Check structures	141,000
Irrigation and drainage structures	<u>37,500</u>
Subtotal	\$436,000
Contingencies (20%)	87,000
Engineering and administration (10%)	52,000
Interest during construction (4%)	<u>11,000</u>
Total Capital Costs	\$586,000
<u>ANNUAL COSTS</u>	
Interest (4%)	23,400
Repayment	3,800
Operation and maintenance	<u>14,000</u>
Total Annual Costs	\$ 41,200

Project Benefits

Facilities of the Yolo Bypass would function primarily during the spring and summer growing season when there would be no flood waters in the Yolo Bypass and when high stages in the Sacramento River would prevent the Colusa Basin Drainage Canal from discharging through the Knights Landing outfall gates. The Yolo Bypass Project would not relieve flood or drainage problems in the Colusa Basin at times when the Yolo Bypass would be flooded heavily by water diverted from the Sacramento River.

Table 18 shows the reductions in frequency and duration of flooding which might be expected in Reach 2 under project conditions. At present, on the average, a flood affecting 3,000 acres will last 18 days and occur in seven out of ten years. Under project conditions, a flood affecting 3,000 acres will last, on the average, only 11 days and occur in about five out of ten years. This is a reduction of 22 percent in the frequency of floods of the size affecting 3,000 acres and a reduction of seven days in the period of inundation. Similar reductions will be realized for floods of other sizes.

The facilities of the Yolo Bypass Project also would reduce the extent of the area flooded; floods under project conditions would affect less land than floods of the same magnitude under pre-project conditions. Figures 11 and 12 show the probability of various sizes of floods in Reaches 1 and 2 and the area which would be flooded under conditions with and without the project. For Reach 1, Figure 11 depicts only those conditions existing during the period April 1 through September 30. Flood conditions in the Yolo Bypass during the winter periods were not considered because the bypass lands are established to convey winter flood waters. In Reach 2, adjacent to the Colusa Basin Drainage Canal, up to

DURATION OF FLOODING IN REACH 2*

Flooded area in acres	Without project		With Yolo Bypass Project	
	Probability of annual occurrence, in percent	Average duration, of inundation, in days	Probability of annual occurrence, in percent	Average duration of inundation, in days
200	100	32	65	19
500	100	29.5	61	17.5
1,000	96	26	58	16
1,500	88	23.5	56	14.5
2,000	83	21.5	54	13
3,000	70	18	48	11
4,000	64	15	42	8.5

*These durations are based on the water stages in the Colusa Basin Drainage Canal and do not allow for time lag as water drains from flooded fields.

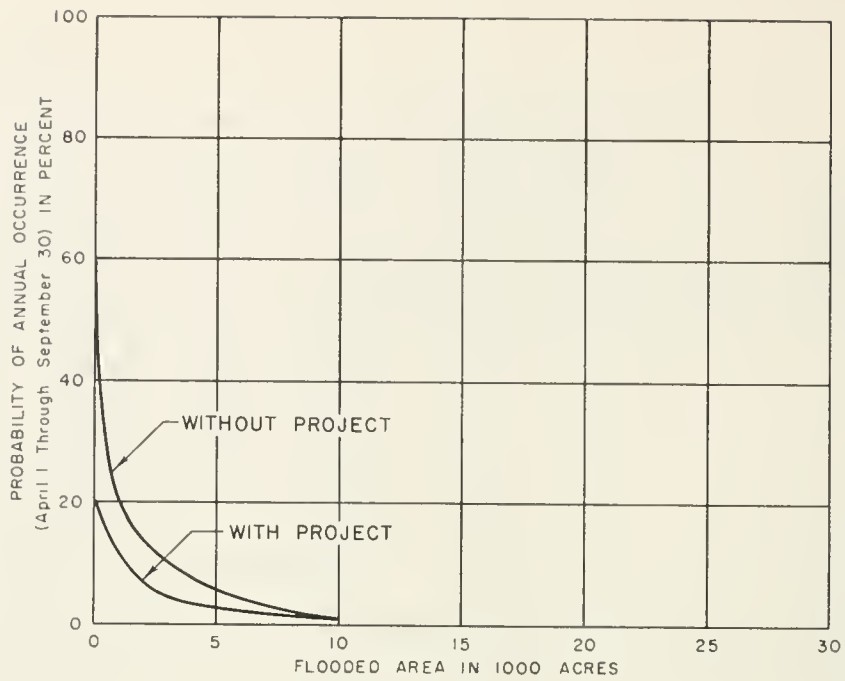

Figure 11. PROBABILITY OF FLOODING (April 1 Through September 30) IN REACH 1, THE NORTHERN YOLO BYPASS, WITH AND WITHOUT YOLO BYPASS PROJECT

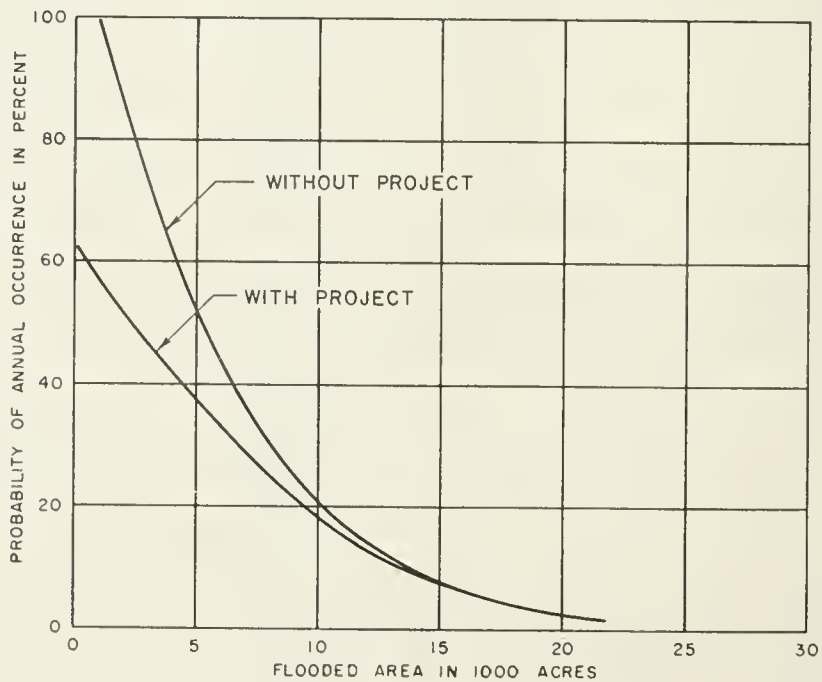

Figure 12. PROBABILITY OF FLOODING IN REACH 2, KNIGHTS LANDING TO COLLEGE CITY, WITH AND WITHOUT YOLO BYPASS PROJECT

500 acres of land presently kept idle in the spring and summer by the threat of floods could be brought into production under project conditions. Although a greater degree of flood relief could be achieved by increasing the capacity of the Yolo Bypass Project drainage facilities, the controlled discharge from the project was limited to the capacity of the ship channel toe drain to avoid any increase in downstream flood damages.

The Yolo Bypass Project would provide benefits to Reaches 1 and 2 by preventing flood damages. Flood damages for conditions at present and for conditions which would exist after construction of the project, as well as the resulting benefits, were computed by the method used to compute such damages and benefits for the Colusa Basin Levee Projects. Average crop damages, based on prices prevailing from 1952 to 1956, correspond to those which occur from flooding during the period from April 1 through September 30. Total flood damages were computed for several sizes of floods and analyzed to determine frequency of occurrence. The probability of flood damage with and without the Yolo Bypass Project is shown on Figure 13.

The average annual crop damage reduction benefit for Reaches 1 and 2 is \$24,000 and \$23,800, respectively. The average annual miscellaneous damage reduction benefit in the same reaches is \$1,400 and \$6,000, respectively. The total average annual flood damage reduction benefit which may be credited to the Yolo Bypass Project, therefore, is \$55,200.

Economic Justification

The Yolo Bypass Project has an average annual cost of \$41,200, an average annual flood damage reduction benefit of \$55,200. The benefit-cost ratio of 1.34 to 1 shows the project to be economically justified.

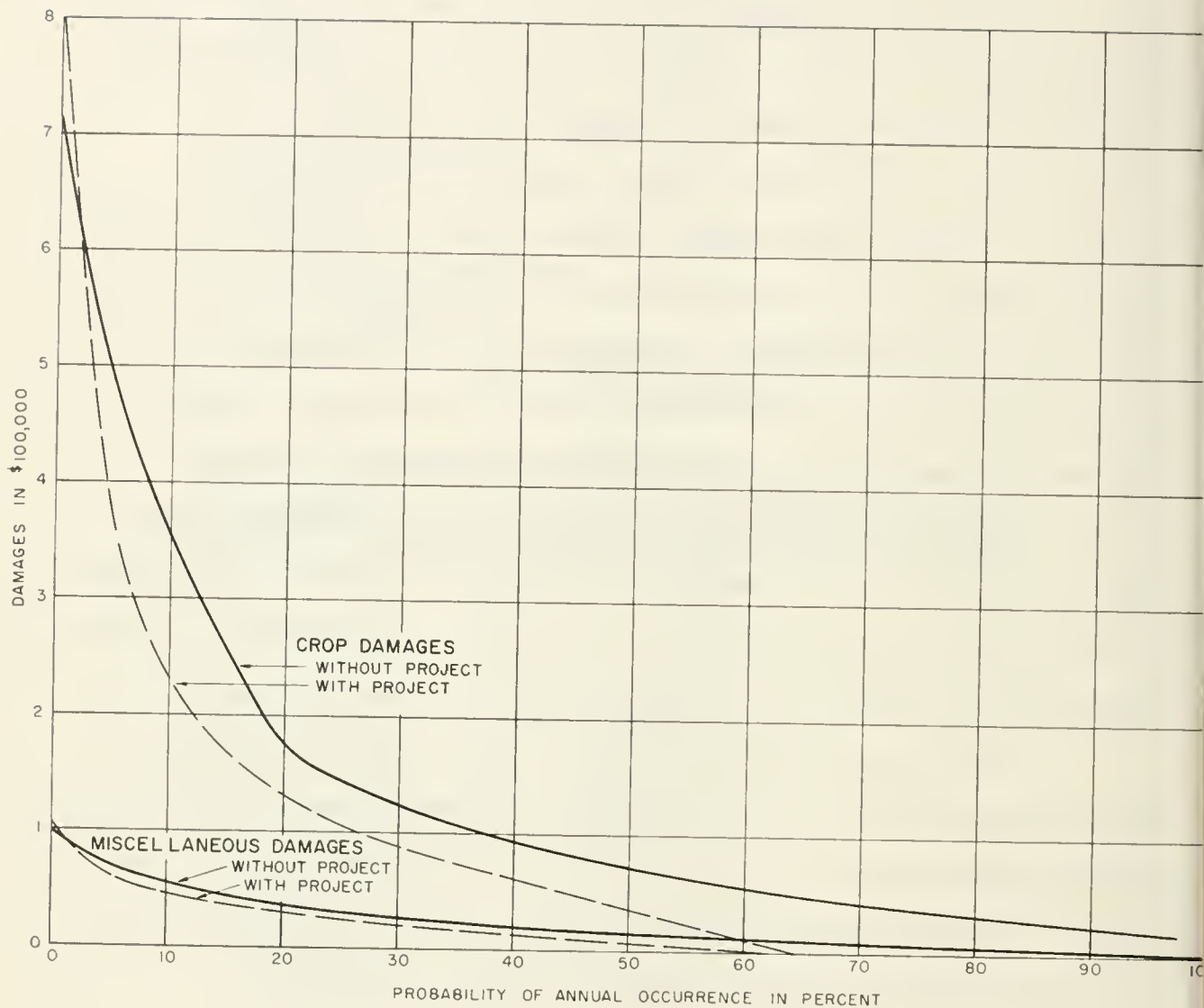

Figure 13. PROBABILITY OF FLOOD DAMAGE WITH AND WITHOUT YOLO BYPASS PROJECT

Although the capital cost of the project, estimated to be \$586,000, is relatively low, project benefits accrue to a relatively small area within the Colusa Basin and to only a small number of land owners. No analysis was made of a possible method for financing, constructing, and operating this project, nor was an analysis made of the ability of the beneficiaries to pay for the project.

CHAPTER V. CONCLUSIONS AND RECOMMENDATIONS

Principally an agricultural area, the Colusa Basin is also of great value as a habitat for wildlife and an area for recreation. The natural advantages of this area are flat topography, long hot summers, and a good water supply. From the standpoint of both texture and alkalinity, the poor quality of the soil in much of the area has restricted crop production largely to rice and irrigated pasture. Agricultural development began at an early date and has continued in conjunction with the reclamation of lands from frequent and widespread flooding from the Sacramento River.

Reclamation works protect the basin against flooding from the Sacramento River, but although these works have provided a high degree of protection to certain lands, they have not controlled floods from runoff of western tributary streams or from irrigation return water.

As a result of field investigation and the analysis of available data on flood control and drainage problems in the Colusa Basin, the following conclusions and recommendations are made:

Conclusions

1. Because flooding from the Sacramento River has been largely controlled by a system of river levees, bypass channels and upstream reservoirs, little damage results from this source.
2. Floods from tributary runoff and precipitation within the basin cause frequent and widespread flooding, restricted mostly to the winter months of October through March. Because the frequency with which this area is flooded has limited development in the flood plain, mainly to agriculture and waterfowl hunting facilities, only moderate amounts of damage occur. The farm lands are seldom planted in the winter. The area contains almost no domestic development and few paved roads or public utilities.

3. Serious flood problems in the Colusa Basin arise from spring flood flows that are created principally, and at times wholly, by irrigation return flows. The Colusa Basin Drainage Canal is inadequate to carry the spring flood flows when high water stages in the Sacramento River prevent discharge through the Knights Landing outfall gates.

4. Although water quality problems exist in some local areas as a result, mainly, of the leaching of alkali lands, the quality of available water supplies in general and of the water in the main drainage channel in particular was found to be satisfactory.

5. Recreation in the Colusa Basin, in the form of hunting for pheasants and migratory waterfowl, constitutes one of the principal resources. A reduction in flooding in the basin could increase slightly the hunting opportunities, but land use changes made possible by flood prevention might seriously reduce the area suitable for migratory waterfowl.

6. The February 1958 flood in the Colusa Basin was the largest recent flood for which records are available. In that month, a maximum daily flow of 23,900 second-feet was recorded in the flood channel of the Colusa Basin Drainage Canal at the Highway 20 Bridge.

7. Future flood and drainage problems in the Colusa Basin may be modified by possible developments as follows:

- a. Future water developments in the Sacramento River Basin will not significantly relieve winter floods in the Colusa Basin, but may cause summer or fall drainage floods not presently experienced. It is assumed that any flood conditions induced in this manner would be alleviated by those responsible.
- b. Flood flows from streams tributary to the Colusa Basin Drainage Canal are expected to be little changed in the future unless the carrying capacities of the tributary channels are increased. Such increased capacities could increase flood peaks in the drainage canal.

- c. Predicted land use changes will result in somewhat larger irrigation return flows throughout the summer months, but no significant increase in magnitude or change in frequency of damaging spring drainage flows is expected to occur.

8. Flood characteristics used herein for the design and analysis of flood control and drainage projects were assumed to remain essentially the same throughout the future fifty year period as experienced in the past. Frequency studies indicate that a flood with a probability of occurrence of two percent (one expected to be equalled or exceeded once in 50 years on the average) would have a peak discharge of approximately 25,000 second-feet in the Colusa Basin Drainage Canal at the Highway 20 Bridge near Colusa.

9. On the basis of the frequency of occurrence of floods, the future crop pattern estimated to prevail without additional flood protection, and those farm costs and prices which prevailed from 1952 through 1956, it was estimated that crop flood damages in the Colusa Basin would average \$150,000 a year.

10. It was similarly estimated that without additional flood protection, miscellaneous flood damages to private property and public facilities would average \$46,000 a year.

11. Engineering works for solution of flood and drainage problems were designed to operate without interference to water rights and diversion of water for irrigation uses.

12. The Colusa Basin Levee Projects were evaluated to determine the degree of protection afforded by each of three sizes of levee projects designed. These projects would protect lands in the Colusa Basin between Knights Landing and Willows from flooding from the Colusa Basin Drainage Canal and Willow Creek. The Two Percent Project, (once in 50 year flood protection) with a capital cost of \$26,033,000 and an annual cost of \$1,771,000 would

provide annual benefits of \$578,000. The Five Percent Project, (once in 20 year flood protection) with a capital cost of \$23,322,000 and an annual cost of \$1,549,000, would provide annual benefits of \$550,000. The Ten Percent Project, (once in 10 year flood protection) with a capital cost of \$20,126,000 and an annual cost of \$1,365,000, would provide annual benefits of \$544,000. In the case of each project, costs would exceed benefits, and therefore not one of the levee projects was found to be economically justified for the present or expected future level of development in the Colusa Basin.

13. A study of the wildlife aspects of the Colusa Basin Investigation was not required under the authorizing legislation. However, until this aspect of the problem has been fully investigated, the proper approach to the solution of the problem cannot be ascertained with a high degree of confidence. This is particularly true with respect to possible state or federal participation in a project, for the wildlife aspects are of great interest and importance to the public at large and would necessarily influence any decision reached within the framework of public interest. Even from a local point of view, maintenance of existing wildlife areas may be more beneficial in overall economic terms than alleviation of the local flooding problem.

14. The Foothill Reservoir Project, comprising flood control reservoirs on 17 tributary streams in the western foothills, was determined to be a less desirable solution to flood and drainage problems in the Colusa Basin than that provided by any of the Colusa Basin Levee Projects. The capital cost of the Foothill Reservoir Project would be \$28,760,000. Because this cost would exceed that of any of the levee projects, and because the accomplishments and benefits of the project would be less than those of any of the levee projects, the project would not be economically justified.

15. Watershed management, coupled with some levee works in the valley area, might provide an inexpensive way to reduce flood hazard. The reduction in flood hazard resulting from watershed management was not evaluated due to the lack of data applicable to the foothill area.

16. The Yolo Bypass Project would increase the outlet capacity of the Knights Landing Ridge Cut into the Yolo Bypass and improve drainage in the area. It would function primarily to alleviate damages resulting from irrigation return flows. The project would protect lands in the lower Colusa Basin between Knights Landing and College City and in the northern Yolo Bypass between the Sacramento Deep Water Ship Channel and the mouth of the Knights Landing Ridge Cut. Two check structures would maintain summer water levels at the elevations required for pumped diversions. The Yolo Bypass Project, with a capital cost of \$586,000 and an annual cost of \$41,200, would provide annual benefits of \$55,200. The benefit-cost ratio -- 1.34 to 1 -- indicates economic justification.

Recommendations

It is recommended that:

1. Although an improved drainage channel and levee system essentially as described herein comprises the most desirable engineering solution to existing and foreseeable flood problems, it not be adopted for construction at this time by local, state, or federal interests because the costs greatly exceed the benefits.

2. The economic justification of an improved drainage channel and levee system be re-evaluated in the future when improved land use and the threat of excessive damage thereto creates a greater demand for flood protection.

3. Future reclamation and flood protection provided by local interests to limited areas within the Colusa Basin be made compatible with an eventual basin-wide plan such as the Two Percent Levee Project.



4. The channels of tributary streams entering the Colusa Basin Drainage Canal from the west be maintained essentially in their present condition.

5. Future analysis of flood control and drainage systems in the Colusa Basin include recreation and wildlife data sufficient in detail and scope to allow evaluation of these resources to be included in determinations of economic justification and financial feasibility.

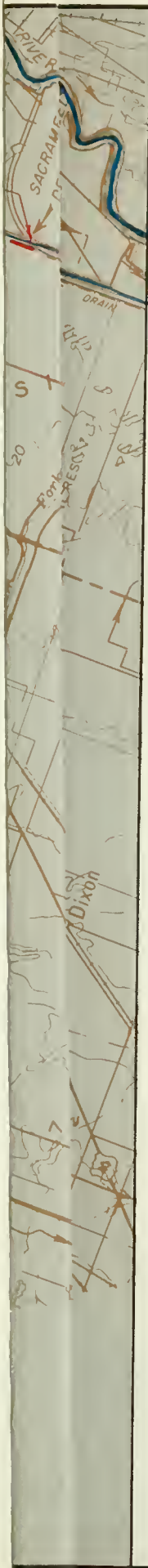
6. The Yolo Bypass Project as described herein and shown to be economically justified to be adopted by an appropriate local districts or public agency for construction to alleviate flooding along the southern reach of the Colusa Basin Drainage Canal and in the northern Yolo Bypass.



LEGEND

-  HISTORICALLY FLOODED AREA
-  POSSIBLE LEVEE AND DRAINAGE PROJECTS
-  POSSIBLE FOOTHILL RESERVOIR PROJECT

STATE OF CALIFORNIA
 THE RESOURCES AGENCY OF CALIFORNIA
 DEPARTMENT OF WATER RESOURCES
 NORTHERN BRANCH
 COLUSA BASIN INVESTIGATION



**EXISTING AND POSSIBLE
 FLOOD CONTROL AND DRAINAGE FEATURES**

SCALE OF MILES

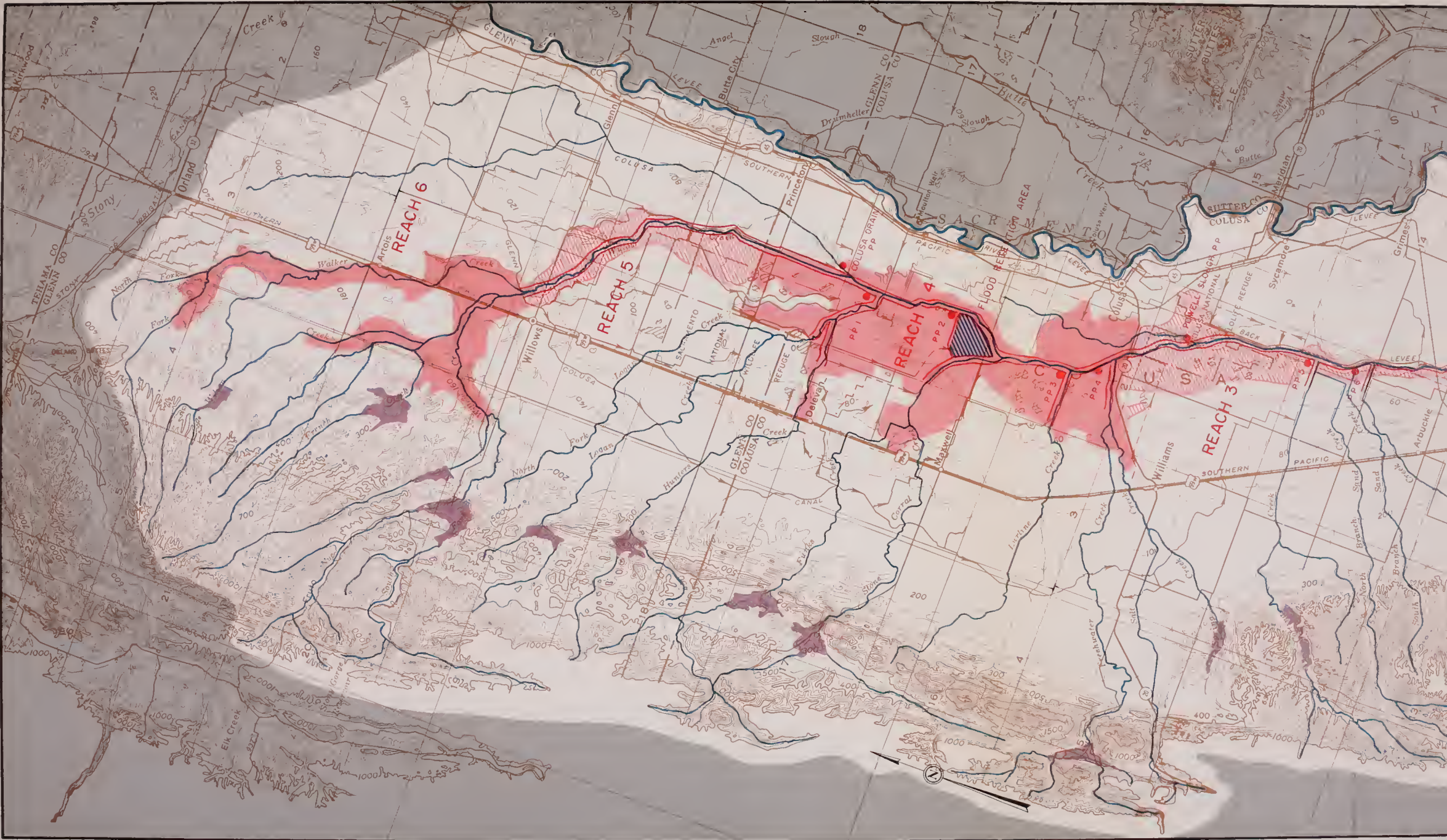

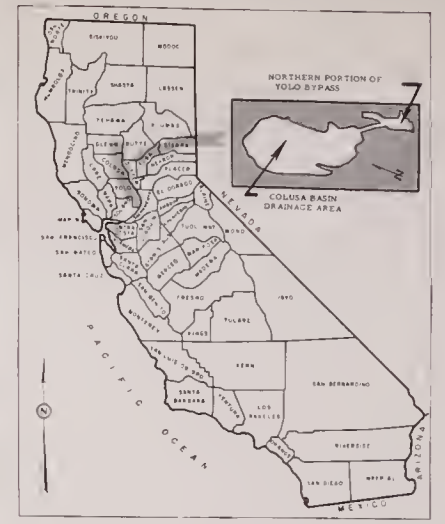



- LEGEND
-  HISTORICALLY FLOODED AREA
 -  POSSIBLE LEVEE AND DRAINAGE PROJECTS
 -  POSSIBLE FOOTHILL RESERVOIR PROJECT

STATE OF CALIFORNIA
 THE RESOURCES AGENCY OF CALIFORNIA
 DEPARTMENT OF WATER RESOURCES
 NORTHERN BRANCH
 COLUSA BASIN INVESTIGATION

**EXISTING AND POSSIBLE
 FLOOD CONTROL AND DRAINAGE FEATURES**



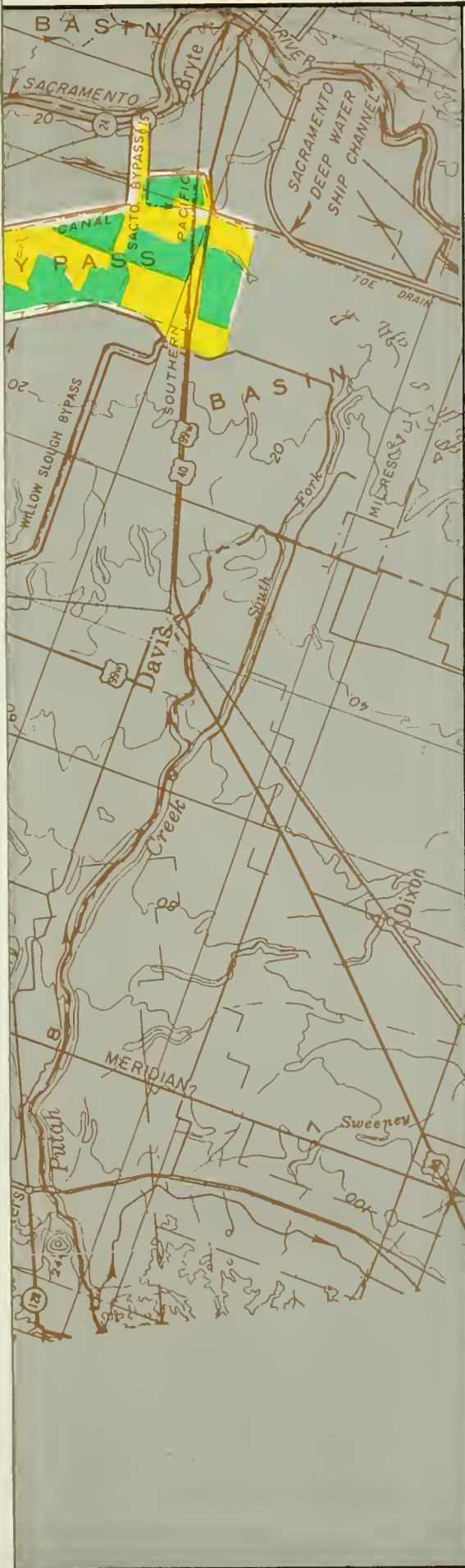

LEGEND

- PRESENTLY IRRIGATED LANDS
- IRRIGABLE VALLEY LANDS
- IRRIGABLE HILL LANDS

STATE OF CALIFORNIA
 THE RESOURCES AGENCY OF CALIFORNIA
 DEPARTMENT OF WATER RESOURCES
 NORTHERN BRANCH
 COLUSA BASIN INVESTIGATION

IRRIGATED AND IRRIGABLE LANDS

1954 - 56

SCALE OF MILES

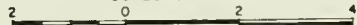

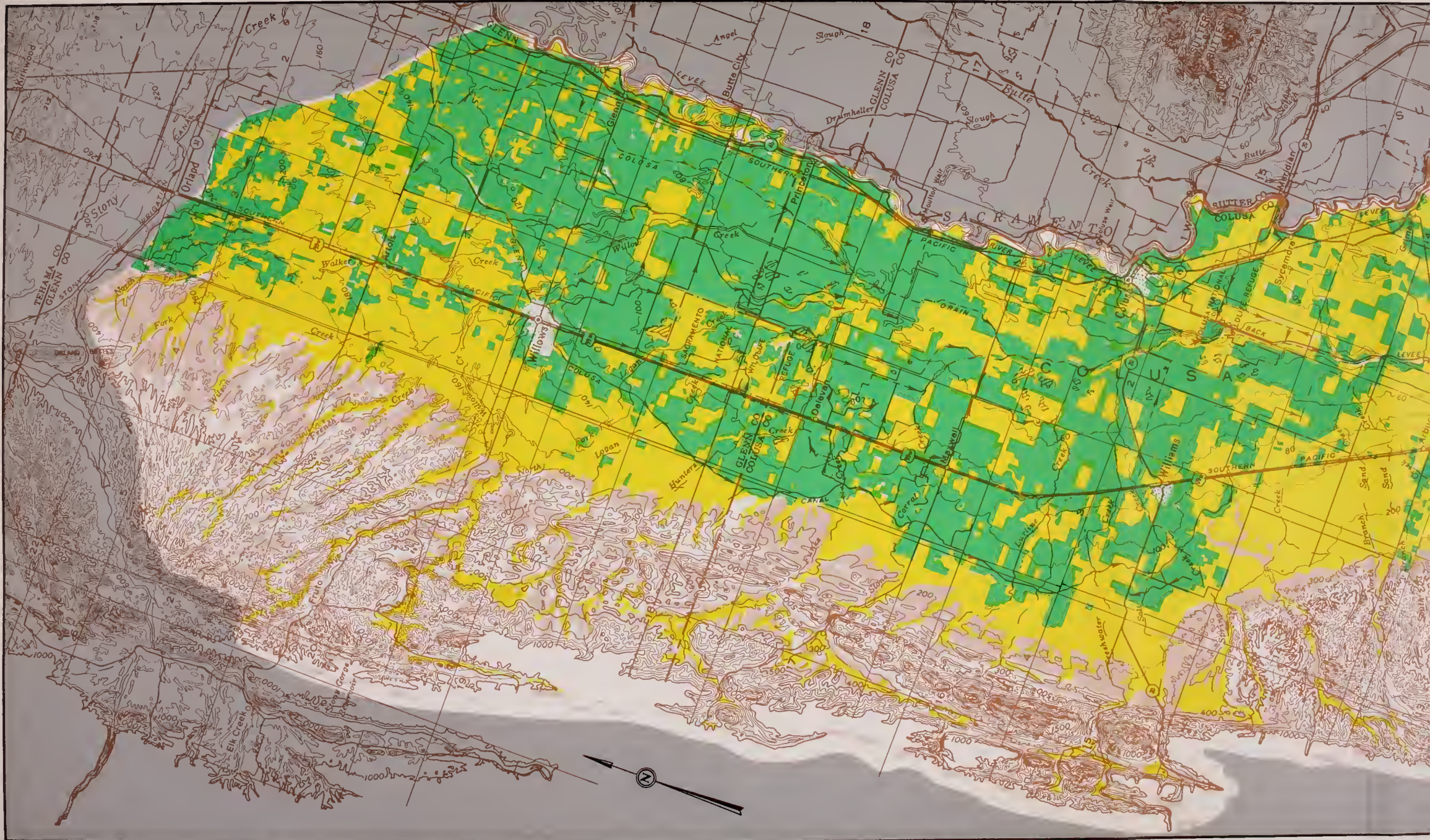

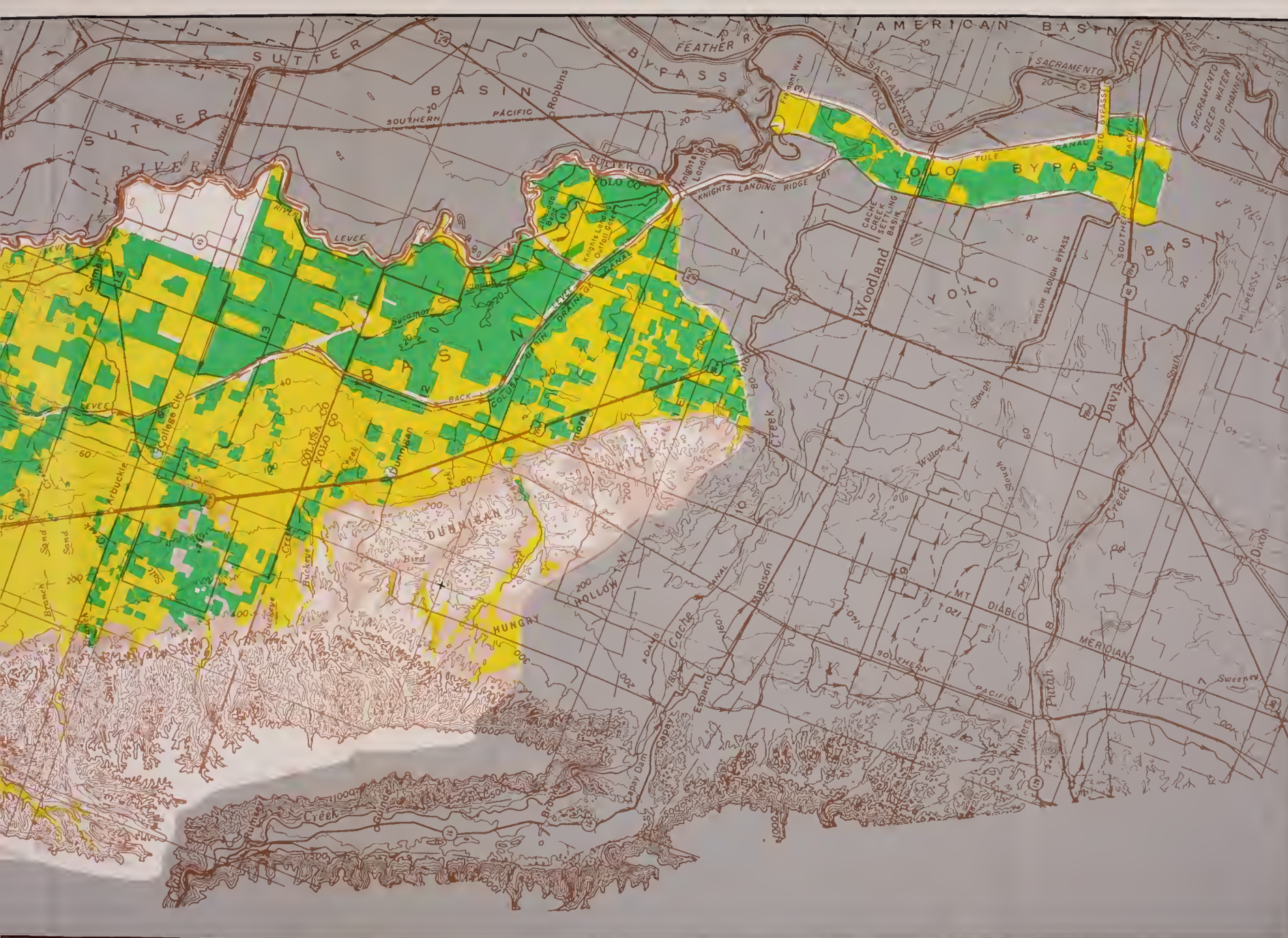

- LEGEND
- PRESENTLY IRRIGATED LANDS
 - IRRIGABLE VALLEY LANDS
 - IRRIGABLE HILL LANDS

STATE OF CALIFORNIA
 THE RESOURCES AGENCY OF CALIFORNIA
 DEPARTMENT OF WATER RESOURCES
 NORTHERN BRANCH
 COLUSA BASIN INVESTIGATION

IRRIGATED AND IRRIGABLE LANDS
 1954 - 56

SCALE OF MILES
 0 2 4



STATE OF CALIFORNIA
 THE RESOURCES AGENCY OF CALIFORNIA
 DEPARTMENT OF WATER RESOURCES
 NORTHERN BRANCH
 COLUSA BASIN INVESTIGATION

PRINCIPAL IRRIGATION WATER SERVICE AGENCIES
 AND
 PROPOSED WATER SERVICE AREAS

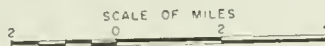

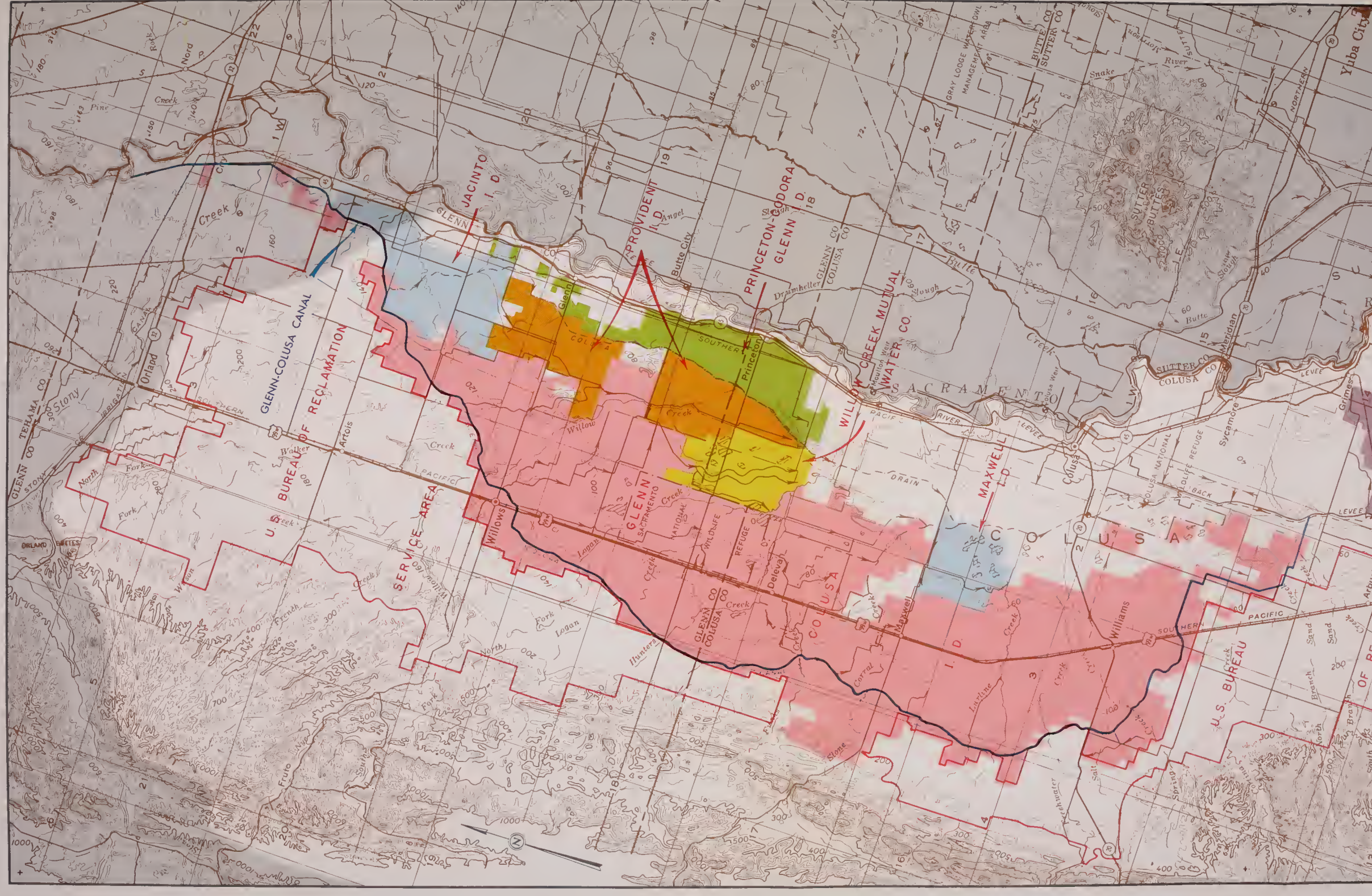

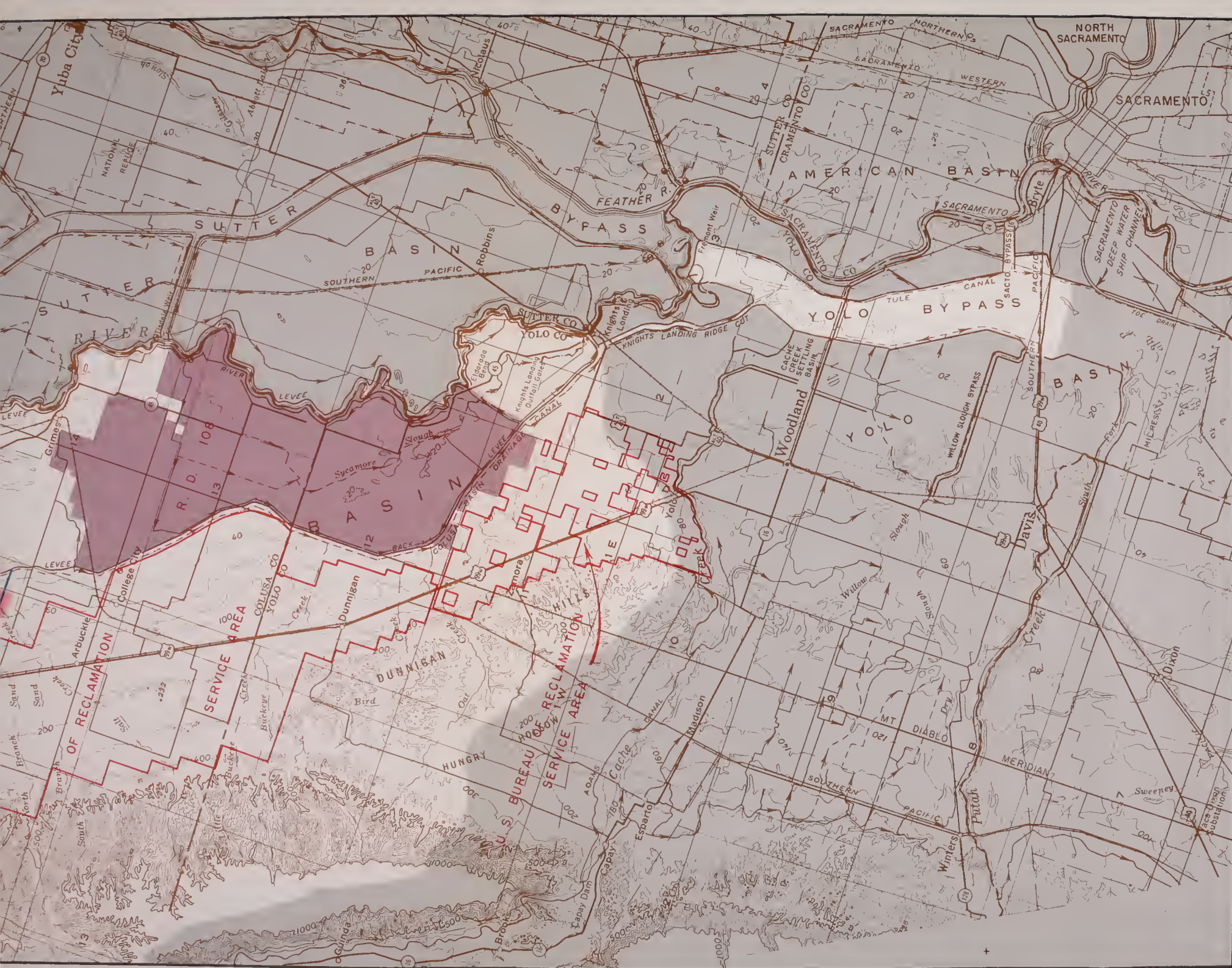

STATE OF CALIFORNIA
 THE RESOURCES AGENCY OF CALIFORNIA
 DEPARTMENT OF WATER RESOURCES
 NORTHERN BRANCH
 COLUSA BASIN INVESTIGATION

**PRINCIPAL IRRIGATION WATER SERVICE AGENCIES
 AND
 PROPOSED WATER SERVICE AREAS**

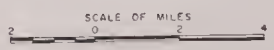

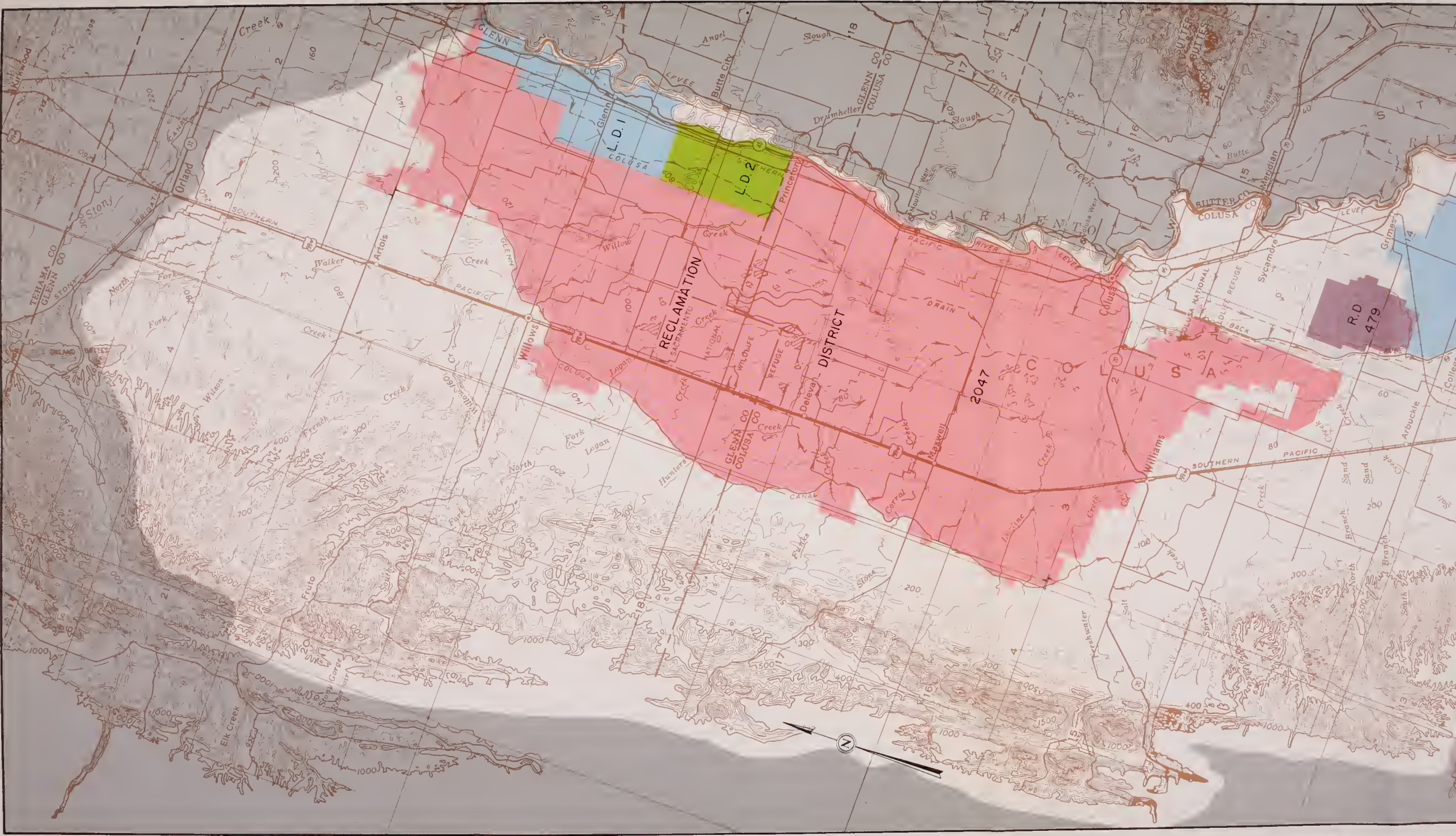

RECLAMATION DISTRICT

L.D.1

L.D.2

2047

R.D. 479

N

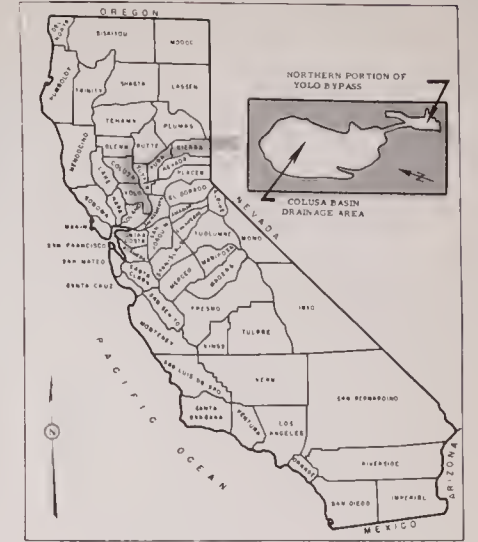

STATE OF CALIFORNIA
 THE RESOURCES AGENCY OF CALIFORNIA
 DEPARTMENT OF WATER RESOURCES
 NORTHERN BRANCH
 COLUSA BASIN INVESTIGATION
 RECLAMATION AND LEVEE DISTRICTS

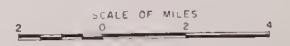

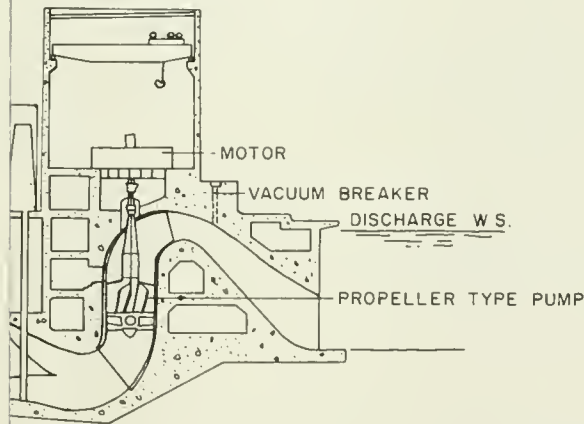
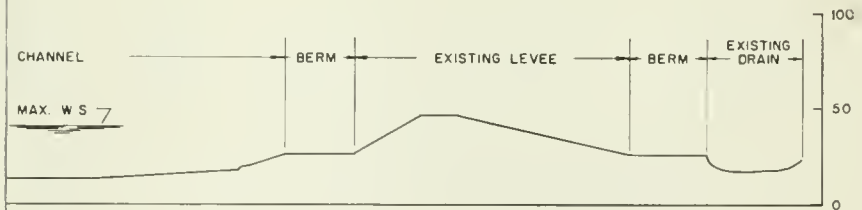
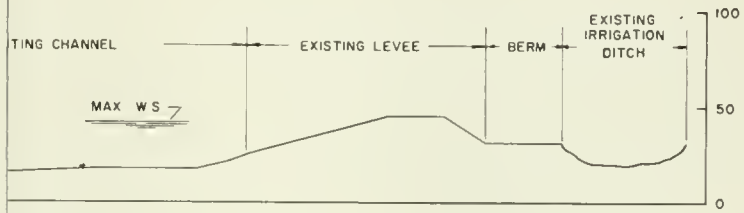
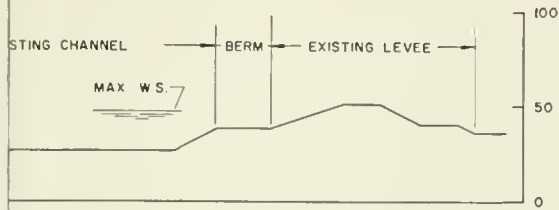

TYPICAL SECTION OF
DRAINAGE PUMPING PLANT

STATE OF CALIFORNIA
THE RESOURCES AGENCY OF CALIFORNIA
DEPARTMENT OF WATER RESOURCES
NORTHERN BRANCH
COLUSA BASIN INVESTIGATION

PROFILE AND TYPICAL SECTIONS OF
COLUSA BASIN LEVEE PROJECTS

1962

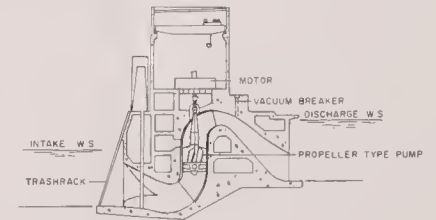
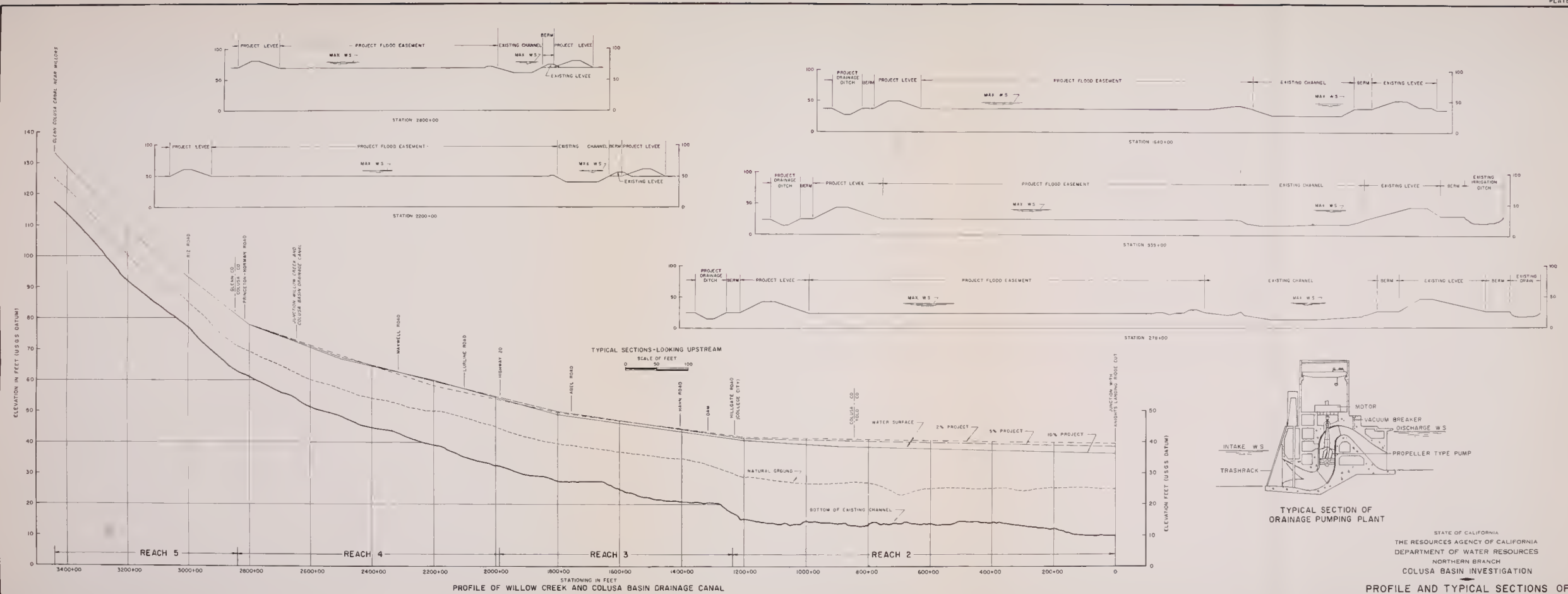

STATE OF CALIFORNIA
 THE RESOURCES AGENCY OF CALIFORNIA
 DEPARTMENT OF WATER RESOURCES
 NORTHERN BRANCH
 COLUSA BASIN INVESTIGATION

PROFILE AND TYPICAL SECTIONS OF COLUSA BASIN LEVEE PROJECTS

1962

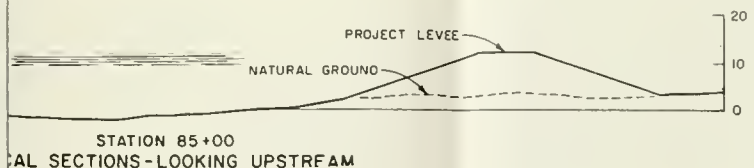
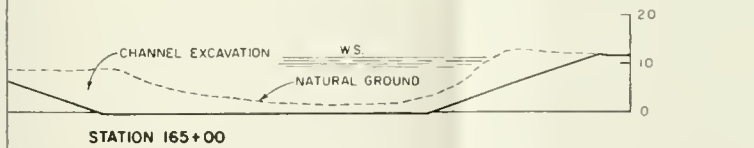
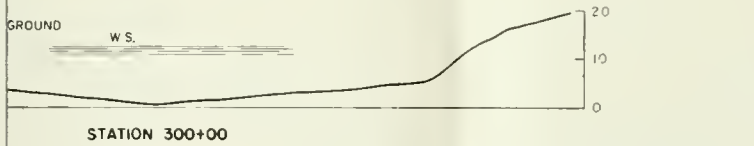
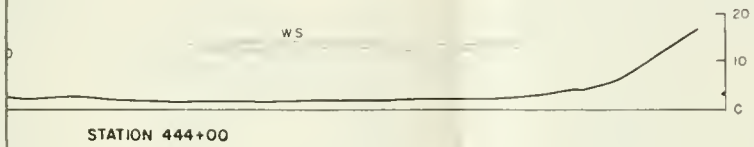
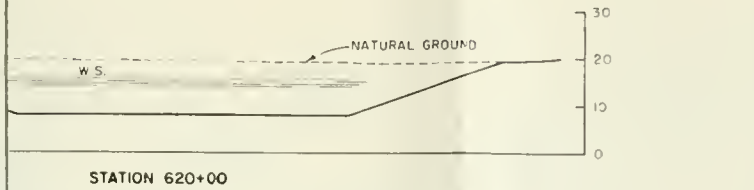

CAL SECTIONS - LOOKING UPSTREAM

SCALE 1" = 20'

STATE OF CALIFORNIA
 THE RESOURCES AGENCY OF CALIFORNIA
 DEPARTMENT OF WATER RESOURCES
 NORTHERN BRANCH
 COLUSA BASIN INVESTIGATION
 PROFILE, PLAN, AND
 TYPICAL SECTIONS OF
 YOLO BYPASS PROJECT
 1962

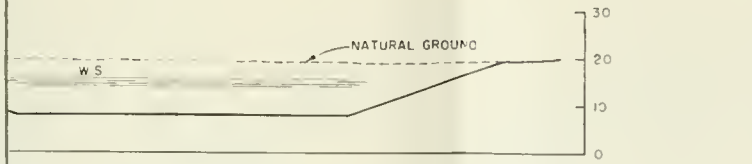

STATION 620+00



STATION 444+00

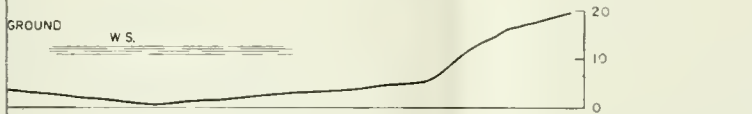

STATION 300+00



STATION 165+00

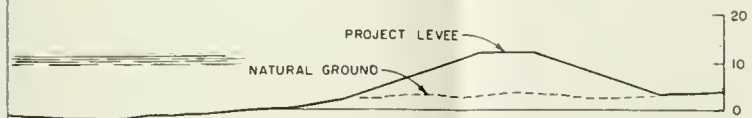

STATION 85+00

CROSS SECTIONS - LOOKING UPSTREAM

SCALE 1" = 20'

STATE OF CALIFORNIA
THE RESOURCES AGENCY OF CALIFORNIA
DEPARTMENT OF WATER RESOURCES
NORTHERN BRANCH
COLUSA BASIN INVESTIGATION

PROFILE, PLAN, AND
TYPICAL SECTIONS OF
YOLO BYPASS PROJECT

1962

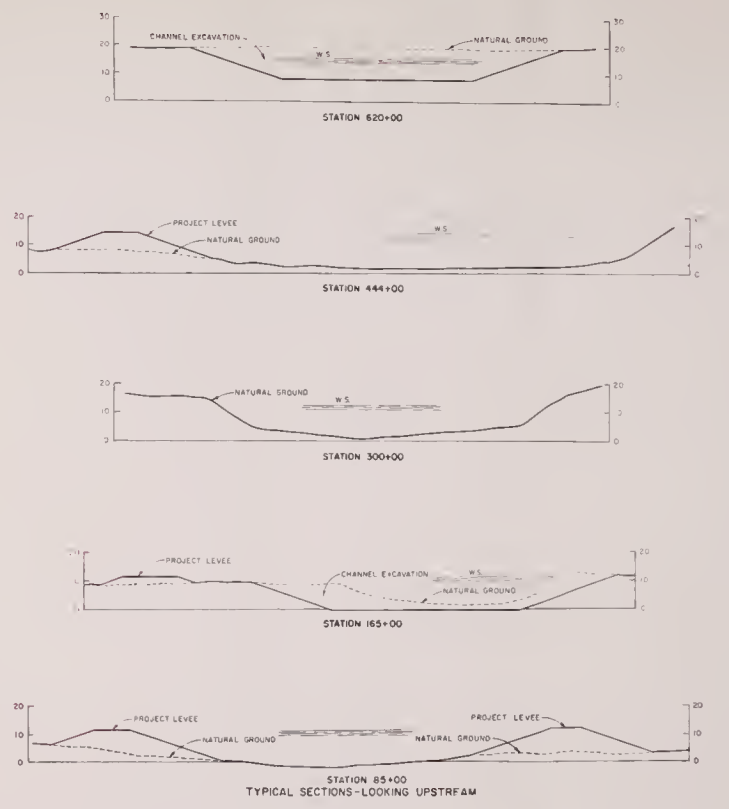
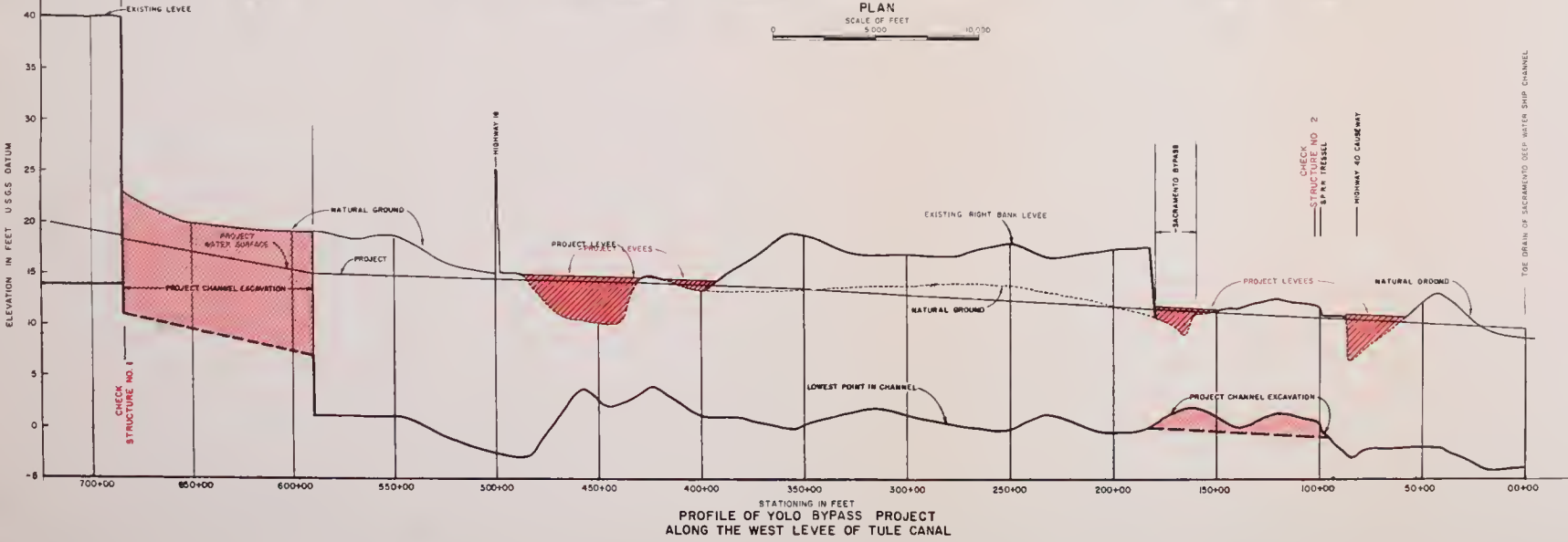
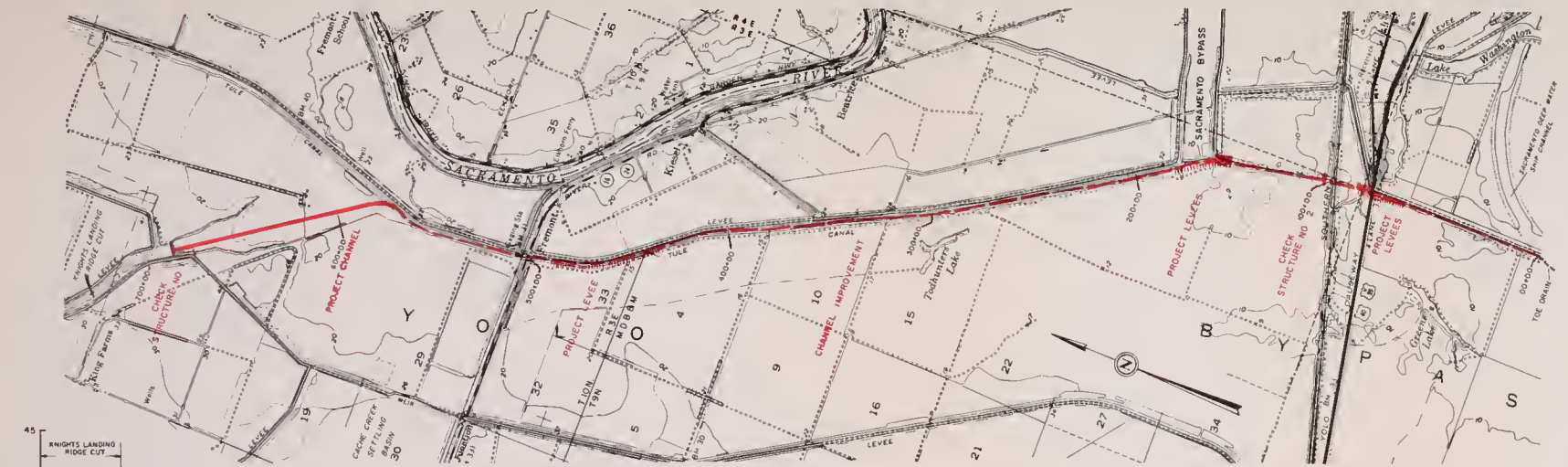

STATE OF CALIFORNIA
 THE RESOURCES AGENCY OF CALIFORNIA
 DEPARTMENT OF WATER RESOURCES
 NORTHERN BRANCH
 COLUSA BASIN INVESTIGATION
 PROFILE, PLAN, AND
 TYPICAL SECTIONS OF
 YOLO BYPASS PROJECT
 1962



THIS BOOK IS DUE ON THE LAST DATE
STAMPED BELOW

RENEWED BOOKS ARE SUBJECT TO IMMEDIATE
RECALL

APR 4 1978

APR 7 REC'D

~~JUN 16 1978~~
JUN 2 REC'D

APR 6 1981

~~JUN 19 1981~~
RECEIVED
Sept 24
SEP 24 1981

PHYS SCI LIBRARY

LIBRARY, UNIVERSITY OF CALIFORNIA, DAVIS

Book Slip-50m-12,'64 (F772s4)458



3 1175 00641 5361

354266

California. Dept.
of Water Resources.
Bulletin.

TC82L
C2
A2
no.1.9

PHYSICAL
SCIENCES
LIBRARY

LIBRARY
UNIVERSITY OF CALIFORNIA
DAVIS



