

THE LIFE HISTORY AND DISTRIBUTION OF LAMPREYS
IN THE SALMON AND CERTAIN OTHER RIVERS IN
BRITISH COLUMBIA, CANADA.

by

Ferdinand Tony Pletcher

B.Sc., University of British Columbia, 1958.

A Thesis Submitted In Partial Fulfilment Of
The Requirements For The Degree Of
Master of Science

in the Department
of
Zoology

We accept this thesis as conforming to the
required standard

THE UNIVERSITY OF BRITISH COLUMBIA

October, 1963

In presenting this thesis in partial fulfilment of the requirements for an advanced degree at the University of British Columbia, I agree that the Library shall make it freely available for reference and study. I further agree that permission for extensive copying of this thesis for scholarly purposes may be granted by the Head of my Department or by his representatives. It is understood that copying or publication of this thesis for financial gain shall not be allowed without my written permission.

Department of Zoology

The University of British Columbia,
Vancouver 8, Canada.

Date September, 1963

ABSTRACT

The analysis of the life history was carried out from collections that were predominantly Lampetra planeri from the Salmon River and Entosphenus tridentatus from the Nicola and Thompson Rivers and from Vancouver Island streams.

The taxonomy of British Columbian lampreys is reviewed and characteristics determined for separating large ammocoetes. The duration of adult life, distribution within streams, length, sex ratio, and fecundity was determined for both species. The spawning behaviour of both species is described from field and laboratory observations. Temperature affected length of spawning period, spawning behaviour, sex ratio, and relative abundance of L. planeri.

Hatching of lamprey eggs was dependent on temperature and differed between the two species. Newly hatched ammocoetes emerged from the gravel nests during darkness, were carried downstream by the current and were deposited in mud beds of quiet pools where they buried. The bottom preference of small ammocoetes was mud > gravel > sand and was reflected in field distributions where greatest concentrations of ammocoetes were found in mud bottoms. The greatest concentration of ammocoetes of mixed age classes was in the deep pool ammocoete beds with sand, leaf, and silt bottoms. Ammocoetes kept in aquaria moved their burrows frequently. Ammocoete intestines contained predominantly diatoms whose abundance corresponded to the season of most rapid ammocoete growth. Adult and ammocoetes were not eaten by salmonid and other fishes of the Salmon

River possibly because of a protective substance in their skin. Transformation to adults for both species occurred in the fall after at least five years of ammocoete life.

Probability paper was used to analyse length-frequency distribution and to construct growth curves. The growth curves of both species was very similar and nearly linear. The average length of life cycle for L. planeri was six years or more and that of E. tridentatus was seven years or more. Adult E. tridentatus parasitized trout in Elsie and Cowichan Lake to the greatest degree during the early spring and attacked salmon and other fish in the sea during the summer months.

ACKNOWLEDGEMENT

The author wishes to express his gratitude to the following persons:

- to Professor P.A. Larkin for his encouragement, inspiration, and supervision in analysing results and preparing the manuscript.

- to Professors W.A. Clemens, P. Ford, W.S. Hoar, T.G. Northcote, N.J. Wilimovsky for their critical reading of the manuscript.

- to Dr. J. Briggs and Dr. C.C. Lindsey for their supervision, suggestions, and advice during the preliminary stages of the study.

- to the Institute of Fisheries for providing financial assistance to collect data and facilities for experimentation.

- to the British Columbia Fish and Game Branch personnel for their assistance in collecting data: G. Hartman, D.R. Hurn, G. Vincent, and W. Fowkes.

- to Doctors G. Pile, D. Milne, and P. Wickett of the Pacific Biological Station at Nanaimo for data and suggestions.

- to Dr. W. Pfeiffer, M.A. Hafeez, and S.N. Ahsan for their histological assistance.

- to the many fellow students for their assistance and suggestions.

- to Frances L. Pletcher for her encouragement throughout the study and in preparing the manuscript.

- to Dr. J.R. Stein for her assistance in identifying diatoms.

- to W.E. Roberts for his assistance in collecting data.

TABLE OF CONTENTS

LIST OF FIGURES	vi
LIST OF TABLES	xi
ACKNOWLEDGEMENT	xii
INTRODUCTION	1
DESCRIPTION OF THE STUDY AREA	6
A. Physical description of the Salmon River	6
1. Mapping and stations	6
2. Drainage	6
3. Flow	11
4. Temperature	11
B. Biological description of the Salmon River	15
1. Plant cover	15
2. Aquatic plants	15
3. Animal life	16
METHODS AND PROCEDURES	17
A. Collecting methods for ammocoetes	17
B. Collecting methods for adults	18
RESULTS AND A REVIEW OF THE LIFE HISTORY	20
A. Review of the taxonomy of B.C. lampreys	20
1. Identification of adults	20
2. Identification of ammocoetes	23
3. Nomenclature	25
4. Comparison of European and B.C. <u>L. planeri</u>	27
B. Adult Life	28
1. Duration of adult life	28
2. Length of adults	31
3. Parasitic life of <u>E. tridentatus</u>	36
4. Sex ratio and length of spawners	41
5. Fecundity of B.C. lampreys	45
6. Spawning of lampreys	51
a. Method of analysis	51
b. Spawning requirements	54
c. Sexual dimorphism at maturity	64
d. Prespawning activity	72
e. First sign of spawning	75
f. Nest building	76

g. Combination rock lifting-digging	78
h. Digging action	78
i. Courting behaviour	82
j. Spawning act	84
k. Internal fertilization	90
l. Length of spawning period	91
m. Communal spawning	94
n. Displacement behaviour	98
o. Effect of temperature	101
C. Ammocoete Life	105
1. Method of hatching lamprey eggs	105
2. Embryonic and early larval life	106
3. Hatching results	106
4. Burrowing and swimming action of larvae	108
5. Collecting emergent ammocoetes	109
6. Bottom type preference	109
7. Intestine analysis of ammocoetes	116
8. Protective nature of lamprey skin	120
9. Distribution of ammocoetes within stream	126
10. Relative abundance of ammocoetes	135
11. Burrowing behaviour of ammocoetes	138
12. Movement of ammocoetes in burrows	140
13. Growth of ammocoetes	141
14. <u>Entosphenus</u> ammocoetes	146
15. Age determination and growth	148
16. Transformation of ammocoetes	161
D. Community relationship and mortality	167
DISCUSSION	170
SUMMARY OF SPAWNING BEHAVIOUR	183
SUMMARY OF LIFE CYCLES	184
CONCLUSIONS	186
LITERATURE CITED	190

LIST OF FIGURES

Figure	Page
1. Pacific lamprey drying in the sun at Moricetown on the Bulkley River	5
2. Rivers and streams in British Columbia where lampreys were collected and studied	7
3. Collecting stations on the Salmon River	8
4. Section of the Salmon River below station 1	10
5. Pool area of the Salmon River	10
6. Mean weekly discharge and maximum water temperature (Salmon River, Station 1, 1960-61)	12
7. Mean weekly discharge and maximum water temperature (Salmon River, Station 1, 1961-62)	13
8. Mean weekly discharge and maximum water temperature (Salmon River, Station 1, 1962-63)	14
9. Collecting equipment	18
10. A standard scoop of substrate with some sand removed to show the ammocoetes at the surface	19
11. Method used to collect ammocoetes in the mud	19
12. Buccal disc and tooth morphology of the non-parasitic lamprey <u>L. planeri</u> of the Salmon River	21
13. Schematic drawings of the buccal disc of the European and Salmon River <u>L. planeri</u>	21
14. Comparison of British Columbian and European Ammocoetes by area of pigmentation	21
15. Buccal disc and tooth morphology of the parasitic lamprey <u>E. tridentatus</u> from the Salmon River	22
16. Schematic drawing of the disc and dentition of <u>E. tridentatus</u> from the Salmon River	22
17. Myotome number in (a) ammocoetes (b) adults	24
18. Shows how the melanophore pattern can be used to distinguish ammocoetes of <u>Entosphenus</u> from <u>Lampetra</u>	26

Figure	Page
19. Length-frequency diagrams of adult (a) <u>Lampetra planeri</u> (b) <u>Entosphenus tridentatus</u>	33
20. Shows the size difference in <u>Entosphenus</u>	34
21. Lamprey scar on the opercule of a 6 lb. pink salmon caught near Sooke	37
22. Rainbow trout gill netted in Elsie Lake showing lamprey scar marks	39
23. Ventral view of intestine of adult <u>Entosphenus</u>	39
24. Length-frequency distribution of adult <u>L.</u> <u>planeri</u> in the Salmon River 1961-62	42
25. Experimental spawning tank	53
26. Spawning tank showing current and bottom arrangement	53
27. Experimental trough to test response of adults to current	58
28. Experimental trough in the stream, and laboratory tanks to test the preference of spawning adults for light	59
29. A pair of actively spawning <u>L. planeri</u> on the Salmon River in bright sunlight	61
30. <u>Lampetra</u> spawning in the shade of a log	61
31. Lateral view of the urogenital papilla of a male <u>L. planeri</u> and the surrounding structures	67
32. Dorsal view of the second dorsal fin of <u>L. planeri</u> comparing the swelling present in the female to no swelling in the male	67
33. Lateral view of the swellings present in the female	67
34. Displays of the upward bend of the tail of females and the downward bend of the tail of males	68
35. Ventral view of the urogenital opening of <u>E. tridentatus</u> showing the papilla and the pseudoanal fin	70

Figure	Page
36. Lateral view of the swelling of the female at the positions indicated by the arrows	70
37. Lateral view and ventral view of the urogenital papilla of the male <u>E. tridentatus</u>	70
38. Salmon River spawning adults from a communal nest	71
39. <u>Lampetra</u> removing rocks from a nest in an aquarium	77
40. <u>Lampetra</u> in an aquarium nest displaying digging action	80
41. Longitudinal section through a nest constructed by a pair of large <u>Entosphenus</u> on the Salmon River	81
42. Spawning sequence of <u>L. planeri</u> in an aquarium	85
43. Communal spawning showing the position taken by the male in grasping the head of the female	88
44. Communal spawning showing the position of the tail of both sexes	89
45. Spawning <u>Lampetra</u> showing the distance between the urogenital openings during the spawning act	91
46. Length of the spawning period at different temperatures for <u>L. planeri</u> of the Salmon River	92
47. Coiling action during communal spawning	96
48. A female courting a male by gliding along his body	100
49. Experimental tank used to test the bottom preference of larger ammocoetes	111
50. Experimental trough to test the bottom preference of larger ammocoetes	111
51. The position that the ammocoetes burrowed in the bottom of a trough with a current of 1 foot per second at the surface	117
52. Epidermis of <u>L. planeri</u> ammocoete from the Salmon River, Dec. 28, 1962	126

Figure	Page
53. Large pool where ammocoetes are deposited at station 1	127
54. Ammocoete beds and spawning nests at station 1	128
55. Station 4, Salmon River	129
56. Station 1 pool, Salmon River	130
57. Length-frequency diagrams of <u>L. planeri</u> in different habitats of the Salmon River on February 23, 1962.	132
58. Length-frequency diagrams of <u>L. planeri</u> in different habitats of the Salmon River on September 9, 1962.	133
59. Length-frequency diagrams of <u>L. planeri</u> in different habitats of the Salmon River	134
60. Concentration of ammocoetes per standard scoop in different bottom habitats of the Salmon River	136
61. Length-frequency distribution of ammocoetes from certain streams in British Columbia	143
62. Length-frequency distribution of ammocoetes from the Salmon River, 1960-1963.	144
63. Growth of ammocoetes (<u>L. planeri</u>) in the Salmon River during the years 1960-62.	145
64. Length-frequency diagram of <u>Entosphenus</u> larvae, August 19, 1961.	147
65. Length-frequency of <u>Entosphenus</u> larvae from the Nicola and Thompson Rivers	149
66. Separation of polymodal frequency distributions of <u>L. planeri</u> ammocoetes using probability paper (Salmon River, Sept. 9, 1962)	151
67. Separation of polymodal frequency distributions of <u>L. planeri</u> ammocoetes using probability paper (Salmon River, February 23, 1962)	152
68. Separation of polymodal frequency distributions of <u>E. tridentatus</u> ammocoetes using probability paper (Thompson and Nicola Rivers, Aug. 19, 1961)	153

Figure	Page
69. Separation of polymodal frequency distribution of <u>E. tridentatus</u> ammocoetes using probability paper (Nicola River, Aug. 2, 1962)	154
70. Growth curve of <u>L. planeri</u> from the Salmon River	156
71. Growth curve of <u>E. tridentatus</u> , Nicola and Thompson Rivers	157
72. Growth curves of British Columbia lampreys (Nicola and Salmon Rivers)	158
73. Length-frequency diagrams of transforming larvae, ammocoetes and adults of <u>Lampetra</u> and <u>Entosphenus</u>	163
74. A comparison of the size and shape of transforming larvae of <u>L. planeri</u>	165
75. A comparison of the head of <u>L. planeri</u>	165

LIST OF TABLES

Table	Page
1. Salmon River stream bottom types	9
2. Incidence of lamprey scars on trout in Elsie Lake	37
3. Fecundity and egg size of British Columbia lampreys	49
4. Analysis of the depth of water and current velocity above nests occupied by spawning adults in the Salmon River	79
5. Collection of emergent larvae from the Salmon River, July 25, 1962	110
6. Bottom type preference of emergent larvae from the Salmon River	113
7. Ammocoete burial rate in the sand and mud in a trough suspended in the Salmon River	115
8. Intestine analysis of ammocoetes from the Salmon River	118
9. Summary of probability paper analysis of two collections of <u>L. planeri</u> and <u>E. tridentatus</u>	155

INTRODUCTION

A study of the life history and distribution of Lampetra planeri (Bloch) and Entosphenus tridentatus (Richardson) was undertaken because of an almost complete absence of information concerning the biology of these two species in British Columbia. Stomach analysis, bottom preference, distribution within the stream, and a statistical analysis of the length-frequency data for the two species of lamprey were carried out on the Salmon River populations during 1961 to 1963. Adult morphological characteristics, fecundity, spawning behaviour, and seasonal distribution were also observed on the study stream during this period. Duration of the various life stages from egg to adult was attempted from the data collected. The ecological relationship between the various stages of lamprey growth and the other community members is discussed as well as the significance of parasitic and non-parasitic life histories from an evolutionary point of view.

The major part of the study was carried out on the Salmon River lamprey population. This river drains delta farmland and flows into the Fraser River near Fort Langley. The lamprey population is an abundant fish form in this river at all seasons of the year and occupies the bottom habitat of mud and sand in the pool areas of the river. Monthly collections of lampreys were made during most of the time between 1961 and 1963. Preliminary spawning behaviour observations were carried out in aquaria in the laboratory as well as in the stream for both species. Specimens of Lampetra were examined from Sweltzer

Creek (Cultus Lake), Port John Creek, Whonnoch Creek, Roberts Creek, Scott Creek, Tsolum River, and the Big Qualicum River for comparison with the Salmon River population. Due to the small population of Entosphenus in the Salmon River (10% of spawning population) and the difficulty in separating the ammocoetes, samples of adults of this species were obtained from the Thompson, Nicola, Big Qualicum, Stamp, Cowichan, Sweltzer, and Port John systems. Ammocoetes of this species were collected from the Nicola, Thompson, Tsolum, and Big Qualicum Rivers.

The life history of Lampetra planeri in Washington State has been studied by Schultz (1930). A survey of L. planeri and E. tridentatus was made in the Cowichan River by Carl (1953). Lampetra planeri has been extensively studied in Europe by Ivanova-Berg (1931), Knowles (1941), Zanandrea (1951, 1954, 1961), MacDonald (1949), and Hardisty (1944, 1951, 1961). Many other major studies have been undertaken on other species of lamprey particularly in Eastern North America. A basic pattern of similarity of life cycle seems to run through the groups.

Lampreys are a significant and interesting vertebrate group because they represent the lowest form of vertebrate found in fresh water lakes and streams as well as being closely related to the oldest vertebrate fossil forms- the Ostracoderms from fresh water Silurian and Devonian remains. They are distributed widely in the temperate regions of the world, being found in North America, Australia, New Zealand, Europe, and

Asia. Lampreys are not distributed in the tropical regions of the world nor in Africa or South America.

Lampreys can be found in most streams and rivers along the West Coast of North America. However they are best known from the migrating schools of Pacific lamprey returning to rivers in the late spring and fall.

Lampreys have been classed as parasitic or non-parasitic by Hubbs (1924), Zanandrea (1961), and Hardisty (1963), but some workers do not agree that lampreys are true parasites. Facultative ecto-parasite may be a better term, but the original terms that appear in the literature will be used throughout this thesis.

The non-parasitic brook lamprey is seldom seen. The strong swimming ability and sucking buccal disc enable lampreys to scale vertical dams, water-falls, and gorges that present impassible barriers to other fish. The common species, Lampetra planeri and Entosphenus tridentatus, are distributed extensively in the Fraser River system, Skeena River, streams of Vancouver Island, and in many other major coastal rivers. A third species, Lampetra ayresi (Gunther), a parasitic lamprey, is common in the Strait of Georgia during the summer months but only one specimen has been taken from fresh water. The distribution of lampreys in the province has been studied and recorded by Carl, Lindsey et al. (1959). Renewed interest in the biology of lampreys has occurred in the last ten years due to lamprey parasitism apparently being directly responsible for the removal of the lake trout population from the Great

Lakes of Eastern Canada. Incidence of parasitism on trout in Cowichan and Elsie Lake on Vancouver Island has been reported on the increase during recent years (D.R. Hurn- British Columbia Fish and Game Branch- personal communication). This life history and population analysis of the lampreys of the Salmon River and other systems will provide the basis for further research and further management of the predator.

HISTORICAL AND COMMERCIAL VALUE OF LAMPREYS

For centuries the Native Indians of British Columbia have used lampreys as food in the smoked, sundried, and salted form. Indians at Moricetown Falls on the Skeena River (Fig. 1) and at Lillooet on the Fraser River catch lamprey by lining their traditional salmon dip nets with fine meshed webbing. The lamprey are easily scooped from the canyon walls as they cling to the walls or to each other in great numbers. In 1948 it was reported that masses of lampreys formed mats along the walls of Hell's Gate Canyon and Lillooet Rapids to a depth of at least a foot of entangled bodies.

King Henry I of England enjoyed eating the primitive but tasty lampreys to such an extent that his inglorious death is attributed to eating too many at one meal.

Little or no commercial use is made of the lampreys of British Columbia. A few European immigrants at Alberni catch the adult lampreys as they migrate up Stamp Falls fish ladder and canyon. The migrating fish are caught by hooks attached to a long pole, much like a herring jig. The larger ammocoetes are occasionally used as bait by trout fishermen because they

maintain vigorous body movements for a long time when baited on a hook. The Chinese community in Vancouver maintain that ammocoetes are the best bait for sturgeon in the Fraser River. Schultz (1930) reported that lamprey in the Seattle area are sold extensively for trout bait. Pike (1953) reported that at Willamette Falls, (Oregon) up to 200 tons of lamprey are taken for reduction purposes during the annual spring migration. A small canning operation uses Petromyzon in Ontario to produce spiced, smoked, and flavoured delicacies. Great numbers of adult lampreys can be obtained at weir dams in the rivers by inserting vertical boards with water running over the boards. The lamprey climb these boards and fall into baskets at the top. Possibly lamprey will be more fully utilized as a food source in the future.

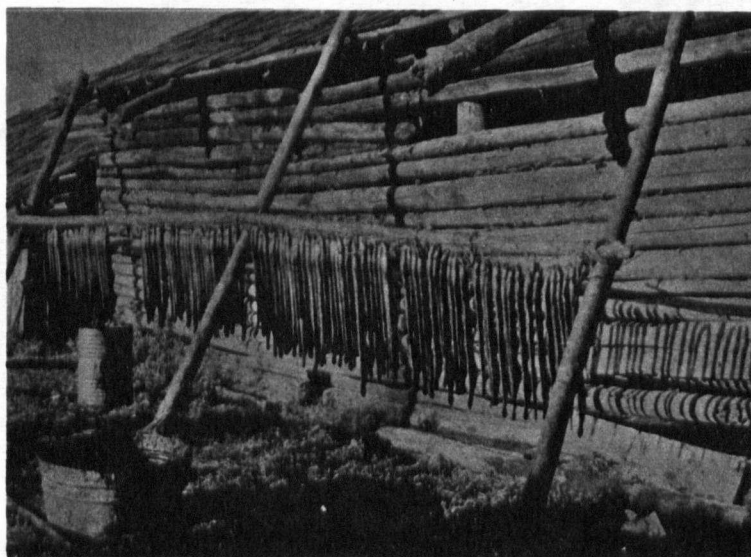


Fig. 1 Pacific lamprey drying in the sun at Moricetown on the Bulkley River.

DESCRIPTION OF THE STUDY AREA

Lampreys were collected mainly in the Salmon River and adjoining streams and on Vancouver Island, as indicated by Fig. 2. Lampreys occur in streams that have a large number of pool areas where sediments can settle, interspaced with areas of gravel. Streams with a steep gradient and little or no pool area are usually not occupied by lampreys. However, the upper reaches of a stream may be filled with rapids and no sediment areas, yet the lower reaches, less than one mile from the sea, may be occupied by lampreys as is the case, for example, in Roberts Creek.

A. Physical Description of the Salmon River

1. Mapping and Stations

See Figures 2 and 3.

2. Drainage

The Salmon River drains delta and plateau farm and wooded area in the Lower Fraser Valley (Fig. 2 and 3). The drainage basin lies at an elevation of less than 300 feet. The drainage area from Jardine to the river mouth (Fig. 3) has been subject to periodic flooding by the Fraser River in the recent past as the soils are alluvial underlain by clay. This section of the river has stable banks and a mud bottom. Few lampreys are found in this section of the stream as it contains no gravel areas for spawning and ammocoetes washed down by flooding are usually deposited further upstream.

From Jardine to Coglan Creek junction the soils are clay

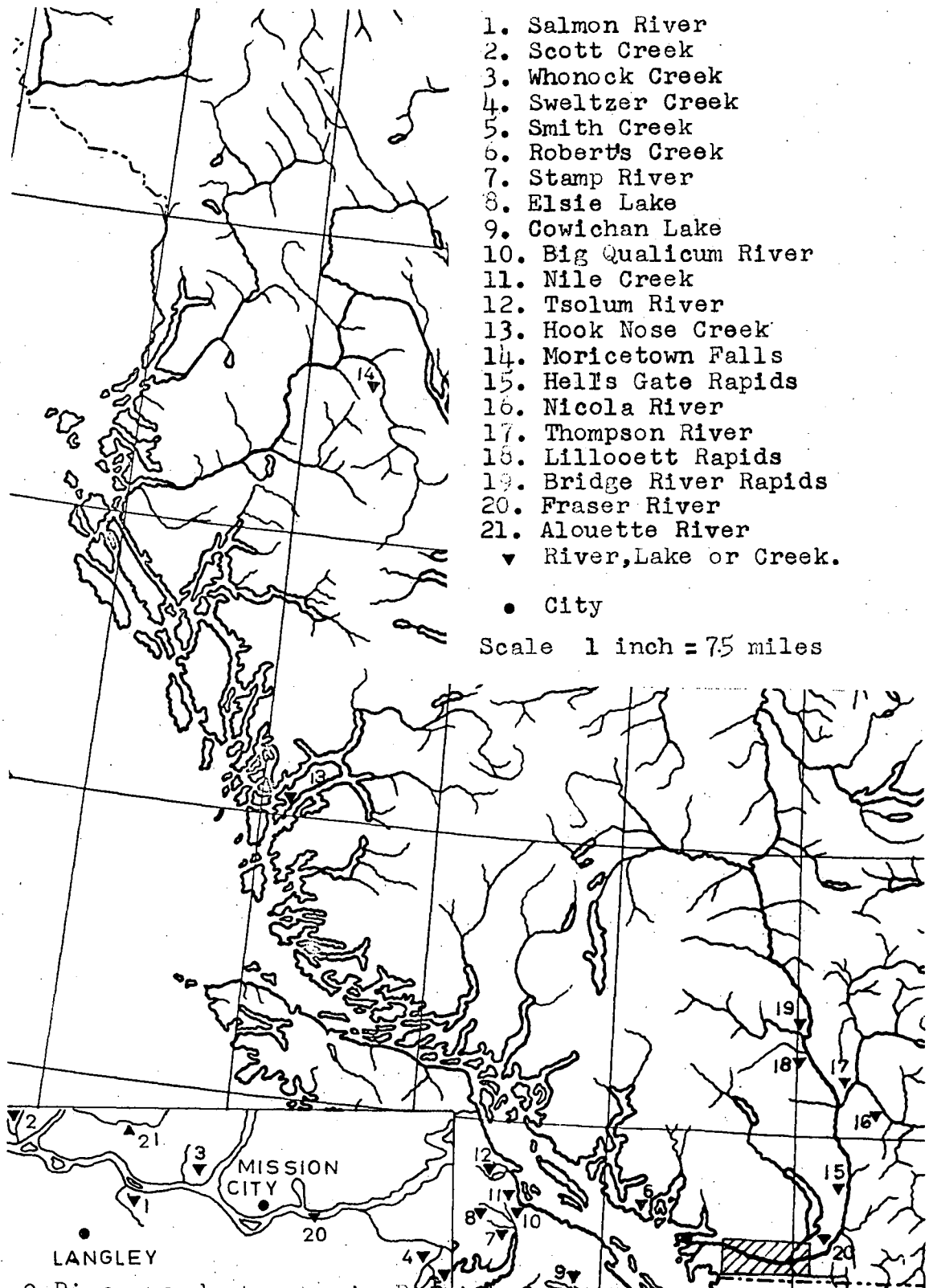


Fig. 2 Rivers and streams in British Columbia where lampreys were collected and studied.

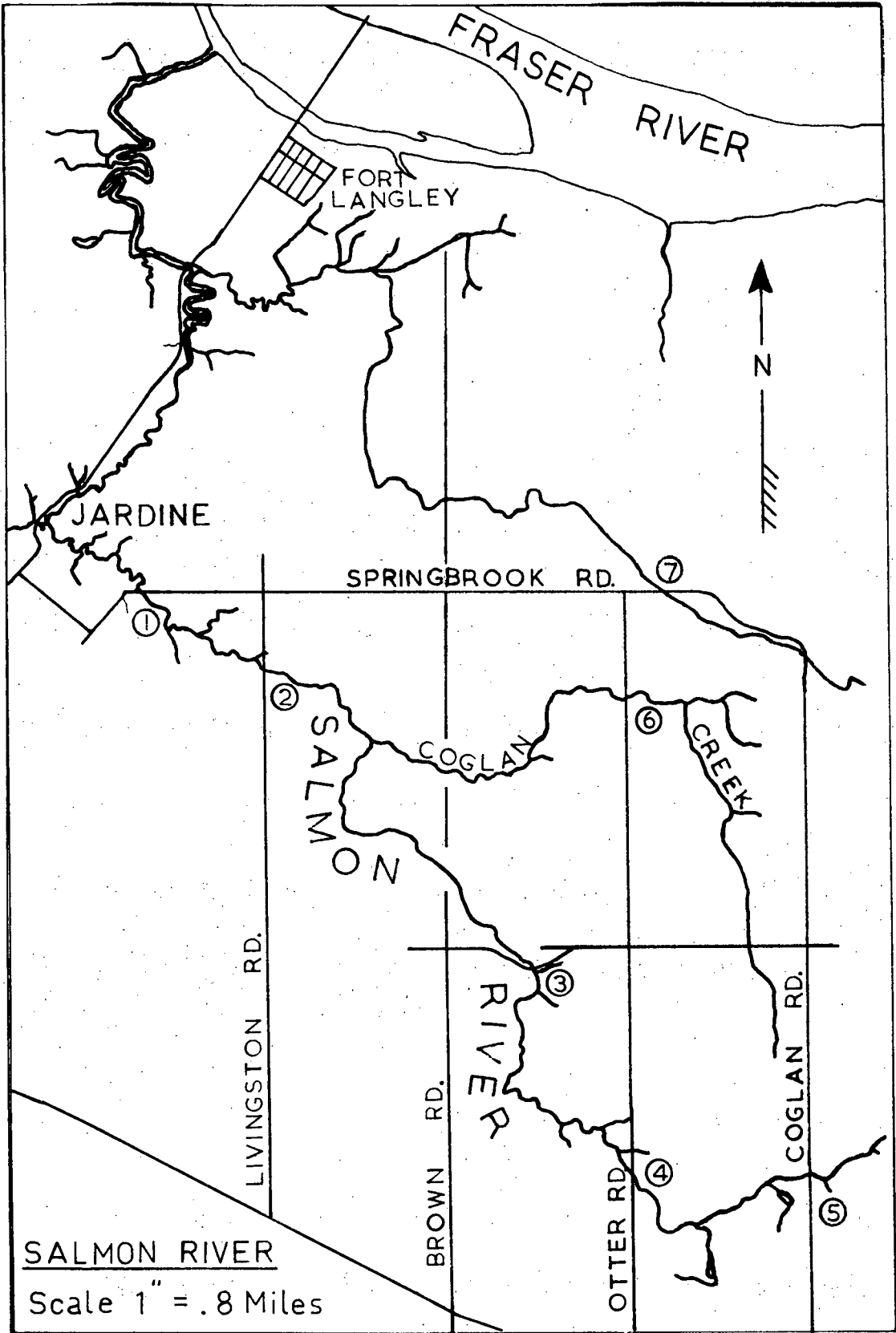


FIG. 3. COLLECTING STATIONS ON THE SALMON R.

loams underlain by dense clay (Kelley and Spilsbury 1939). Ammocoetes are very abundant in the large pool areas of this section of the river and adult Lampetra and Entosphenus are found above the riffle areas during the spawning season (Fig. 4 and 5).

The stream bottom types are shown in Table 1.

Table 1 Salmon River Bottom Types (McMynn and Vernon 1954)

<u>Section of Stream</u>	<u>Miles</u>	<u>Percent</u>
Total length of stream system	22.3	100
Length of stream with unstable banks and no tree cover	11.8	53.0
Length of semi-permanent portions	4.3	19.4
Length of permanent portion	18.0	80.6
Length of permanent stream with unstable banks and no tree cover	7.5	33.6
Length of permanent stream with stable banks and tree cover	10.5	47.0

The section of the river from Coglan Creek junction to above station 5 consists of sand and gravel loams underlain with clays (Keely and Spilsbury 1939). A moderate gradient exists and 30 to 40 percent of the bottom consists of gravel and stones (McMynn and Vernon 1954). Small pool areas occur in this section of the stream where silt, sand, and forest debris are deposited. Spawning was observed throughout this section of the river and ammocoetes were found in the pool and sand bar areas but they were not as densely concentrated as at station 1. The stream bottom between stations 5 and 1 is semi-

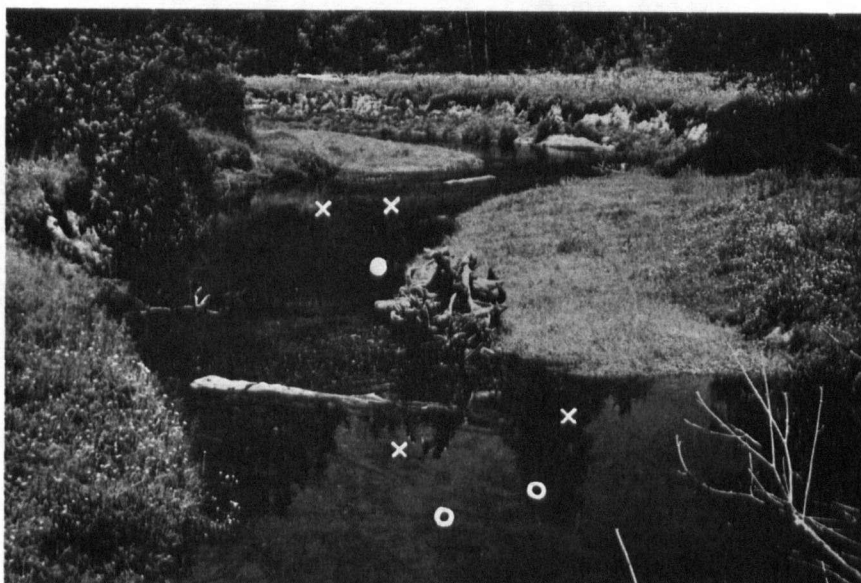


Fig. 4 Section of the Salmon River below station 1.
 X = Lampetra spawning area. ● = Ammocoete area.
 ○ = Entosphenus spawning area.

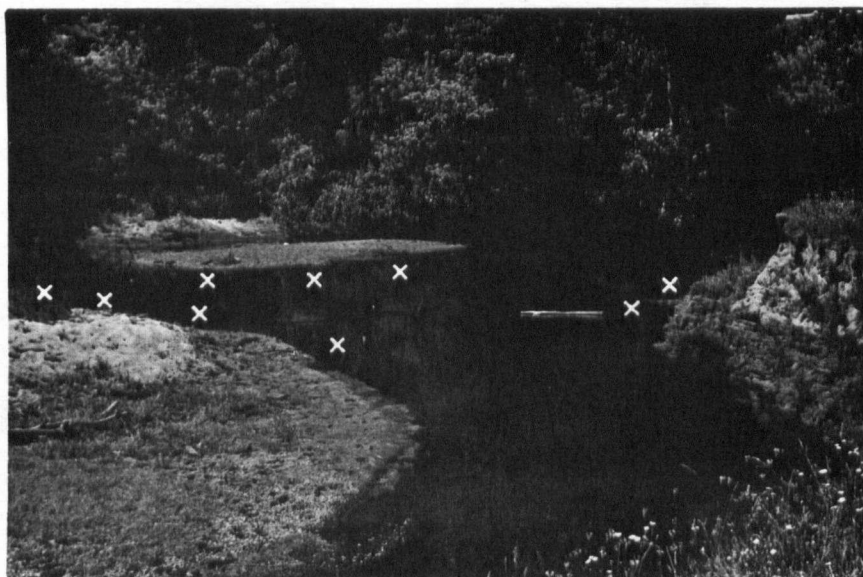


Fig. 5 Pool area of the Salmon River below station 1.
 X = areas where ammocoetes may be collected.

permanent as flooding is continually shifting its position. The lower tributary from station 7 to the mouth did not contain lampreys. Many sediment deposits containing ammocoetes have formed and disappeared during the study period in the stream above Jardine.

3. Flow

A water gauge was located at station 1 and the Water Resources Branch of the Department of Northern Affairs and National Resources recorded the daily flow throughout the study period.

The greatest discharge of water from the Salmon River usually occurs between December and February. A maximum discharge of 720 cubic feet per second (Second-feet) was recorded on December 30, 1962, at station 1, and the minimum discharge of 4.2 second-feet was recorded on April 28, 1963 (Figures 6, 7, and 8). However, in the two previous years the lowest discharge occurred in the June to September periods. Farms bordering the river pump water from the Salmon River during the summer which tends to reduce the flow still further.

4. Temperature

An automatic temperature recorder (Weksler) was maintained by the British Columbia Fish and Game Branch during 1961 and 1962 at station 1. Individual temperature readings were taken with a field thermometer whenever the stream was visited in 1963.

The comparison of maximum weekly water temperature and mean weekly discharge is graphed (Figures 6,7,and 8) for the three years of the study. The maximum water temperature

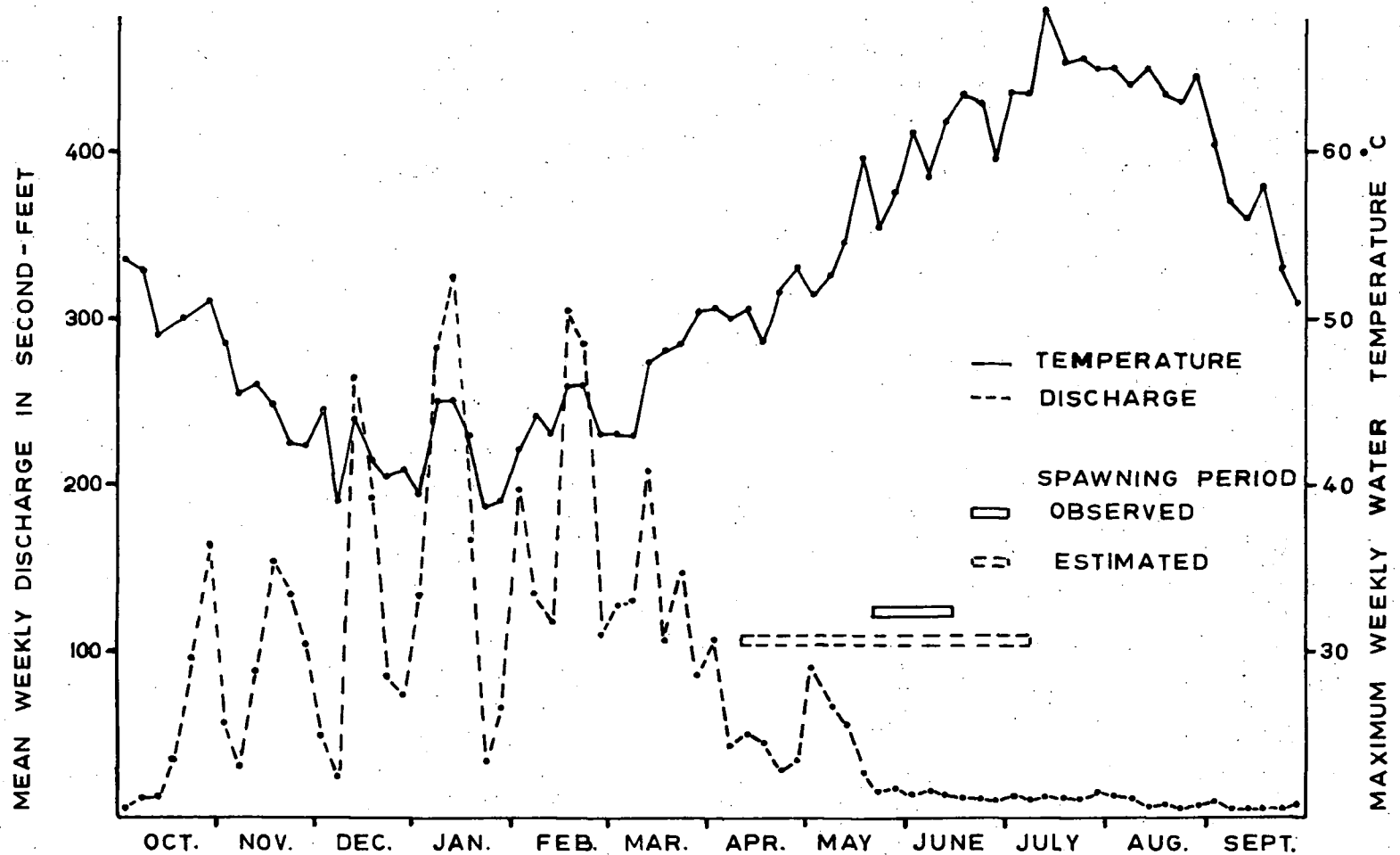


FIG. 6. MEAN WEEKLY DISCHARGE AND MAXIMUM WATER TEMPERATURE (SALMON R., STATION 1, 1960 - 61)

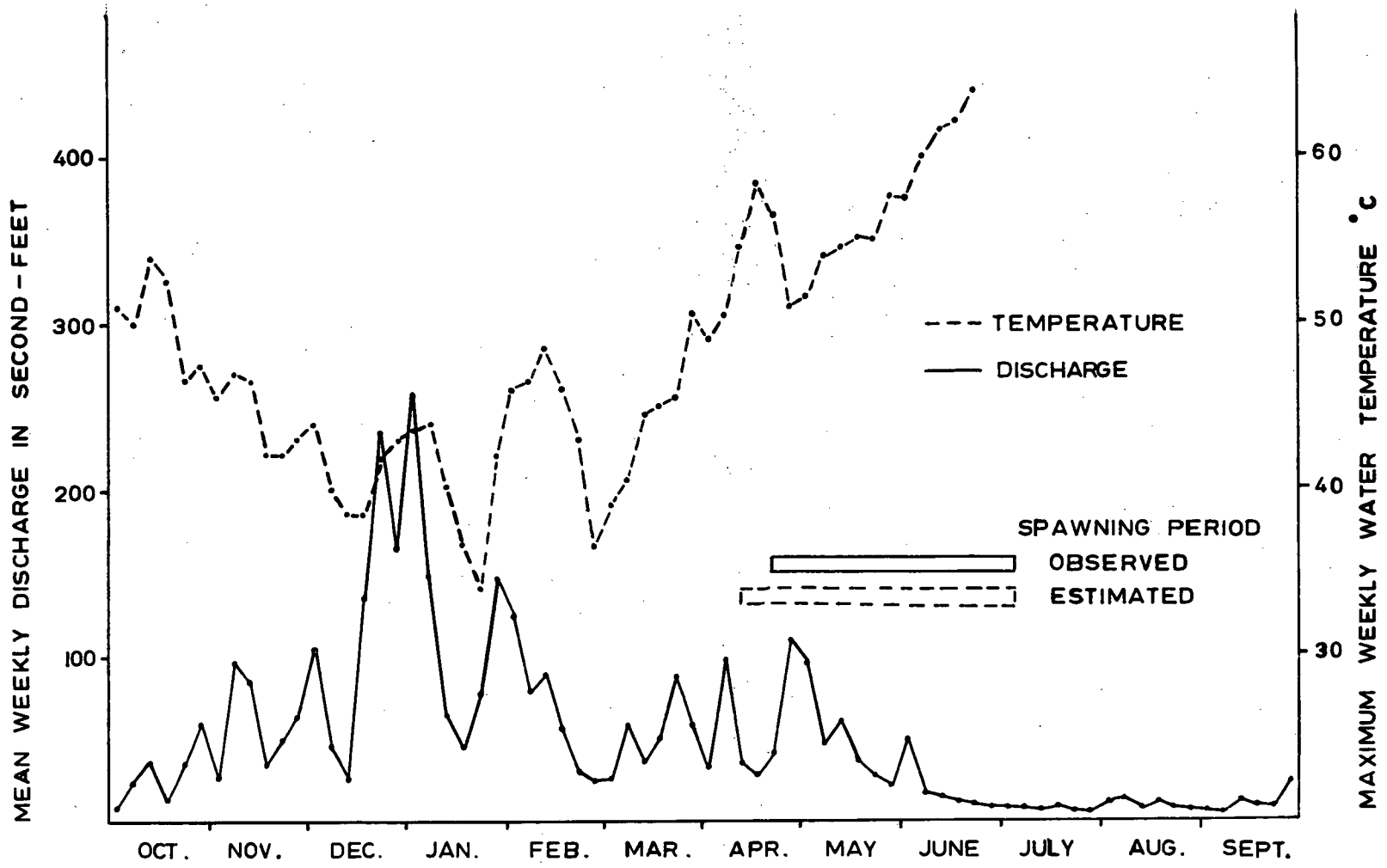
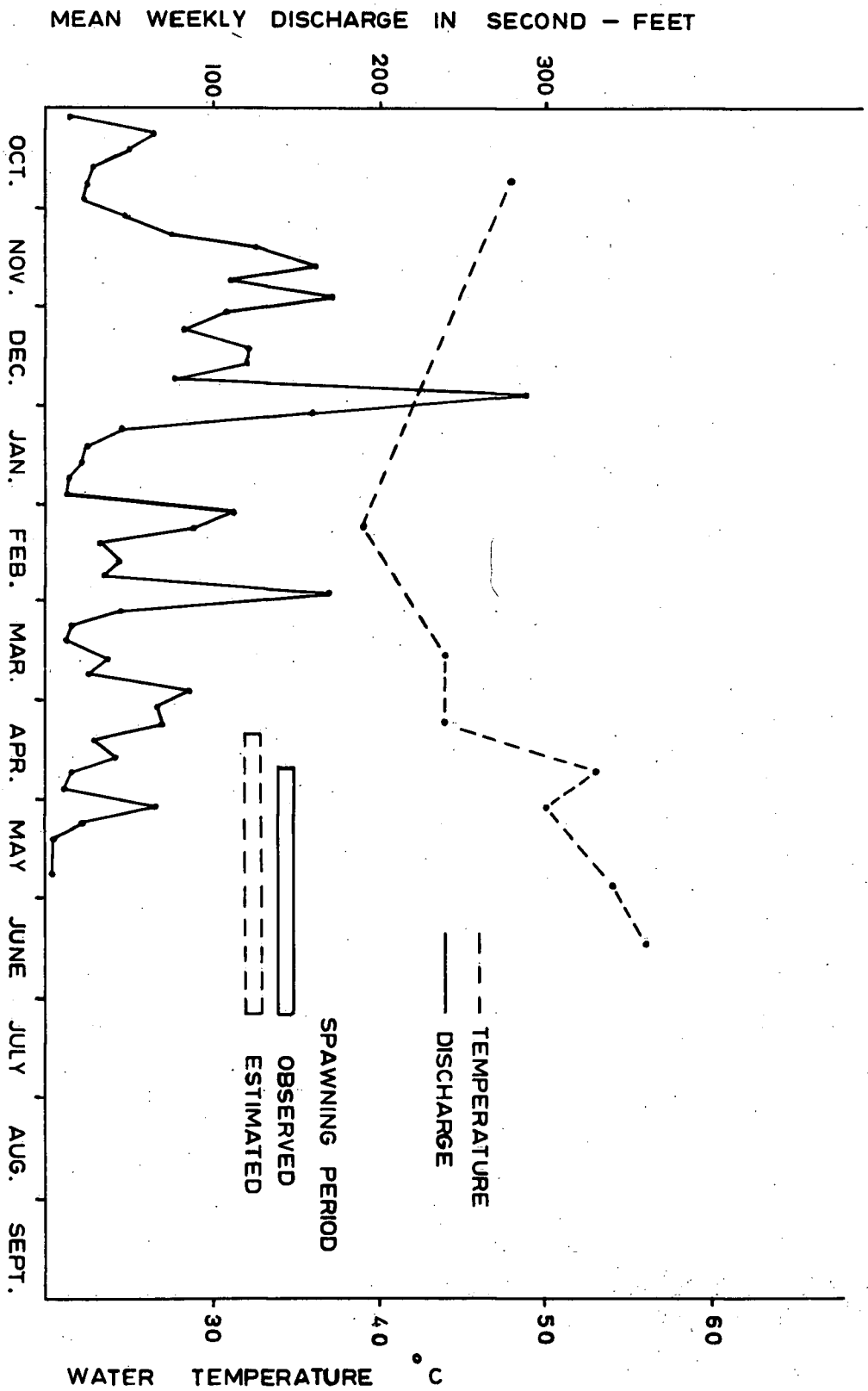


FIG. 7. MEAN WEEKLY DISCHARGE AND MAXIMUM WATER TEMPERATURE FOR THE SALMON RIVER (STATION 1, 1961-62)

FIG. 8. MEAN WEEKLY DISCHARGE AND WATER TEMPERATURE
 (SALMON RIVER, STATION 1, 1962-63).



usually occurs in June or July and the lowest water temperature occurs in January or February.

B. Biological Description of the Stream

1. Plant Cover

The entire drainage area was originally covered with dense coniferous forest, except for a small flood plain near the mouth. The land above the flood plain was cleared for agricultural purposes during the last half century (McMynn and Vernon 1954). The second growth Douglas Fir (Pseudotsuga taxifolia), Western Red Cedar (Thuja plicata), Western Hemlock (Tsuga heterophylla), Broad Leaf Maple (Acer macrophyllum), and Red Alder (Alnus rubra) were replaced by crops of strawberries and hay.

The river banks are lined with Vine Maple (Acer circinatum), Bitter Cherry (Prunus emarginata), Cascara (Rhamnus purshiana), Northwest Willow (Salix sessilifolia), Western Red Cedar and Red Alder. The undercover along the stream consists of Salmon Berry (Rubus spectabilus), Thimbleberry (Rubus parviflorus), Trailing Blackberry (Rubus Vitifolius), Red Elderberry (Sambucus Callicarpa), and Stinging Nettle (Urtica lyallii).

2. Aquatic Plants

Sewage bacteria (Sphaerotilus) were very abundant during the summer months in the Salmon River. Spirogyra and other filamentous pond algae were common in the back water areas and stream bottom during the warmer period of the year. A great variety of diatoms and some desmids were observed to

inhabit the river water throughout the year, as was evident from analysis of lamprey intestines.

Rooted aquatics were represented by Anacharis, Ranunculus, and Potamogeton in the deeper permanent pools of the river.

Great quantities of plant debris accumulated particularly in the fall and was buried in the pool area and sand bars. This material decays at a slow rate, but offers a refuge and possible food source for larger ammocoetes.

3. Animal Life

McMynn and Vernon (1954) sampled the bottom fauna of the Salmon River during the winter and summer and my results agree favourably with their data. They found Ephemeroptera to be the most abundant group followed in abundance by Coleoptera, Plecoptera, Diptera, Trichoptera, Annelida, and Planorbidae. They noticed (as was verified) a rise in numbers of bottom organisms after December with a peak in numbers occurring in April. A scarcity of bottom fauna was particularly noticed during the winter flooding period. Fresh water clams were particularly abundant from station 2 to the mouth of the river. The crayfish (Pacifastacus leniusculus) is abundant, but was collected only during the summer and fall, and occupies a habitat similar to the lamprey larvae.

The Salmon River supports an abundant fish population. Lampreys are the most abundant vertebrate residents in the river throughout the year. Coho Salmon (Oncorhynchus kisutch) are present in five times the density of the other salmonids combined (McMynn and Vernon 1954). The stickleback (Gasteroseus

aculeatus) is a permanent resident throughout the stream. A number of other fish species that are restricted to one part of the stream, or occur only during one part of the season are Steelhead trout (Salmo gairdnerii gairdnerii), cut-throat trout (Salmo clarkii clarkii), prickly sculpin (Cottus asper), and the largescale sucker (Catostomus macrocheilus).

METHODS AND PROCEDURES

A. Collecting Methods for Ammocoetes

Emergent ammocoetes were collected by using a modified Surber Sampler placed in the riffle area of the stream below a spawning location. The sampler was modified by gluing a liner made from a knotted nylon stocking into the collecting mesh of the sampler. This produced folds and a very fine mesh so that the water pressure did not force the delicate bodies of the newly hatched ammocoetes through the mesh. The sampler was placed in the stream and emptied every eight hours.

Flat aluminum trays (25 mm. by 38 mm.) were filled with fine mud and placed in various locations in pools and gravel areas to catch ammocoetes that were being carried downstream. The larvae buried into the mud of the trays and were counted at eight hour intervals when the trays were removed.

The majority of the ammocoetes of all year classes were dug from the bottom of the river with a sturdy scoop attached to a long handle (Fig. 9 and 11). The dimensions of the frame of the scoop are 24 x 20 x 20 x 12 cm. and 1.5 mm. plastic mesh served as screening. A standard scoop of bottom

(Fig. 10) was obtained by digging 8 cm. of the surface over 1 metre of the bottom (approximately 2 liters of sand per scoop). The sediments were usually placed on an inclined plywood box and the ammocoetes were removed by hand and subsequently preserved in 2% formalin.

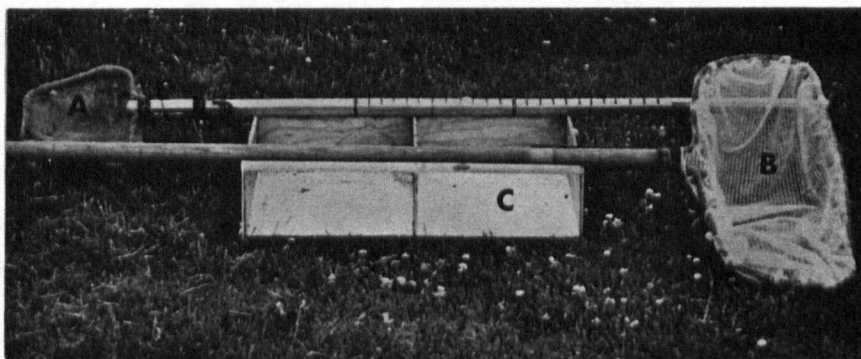


Figure 9. Collecting equipment: A. ammocoete scoop. B. Adult scoop. C. Plywood box used to sort larvae from bottom sediments.

B. Collecting Methods for Adults

A portable 400 volt pulsating square wave direct current electric shocker (O-L Electronic Shocker, Oceanic Instruments Inc.) was used once to collect prespawning adults hiding in the gravel at the end of large pools (Fig. 11).

An eight foot seine was used to collect the gravel areas at the end of large pools and the riffle areas. The seine was held downstream by one person while the other turned over rocks upstream with a shovel. Sweeps of the pools and bottom areas with the seine were also carried out.

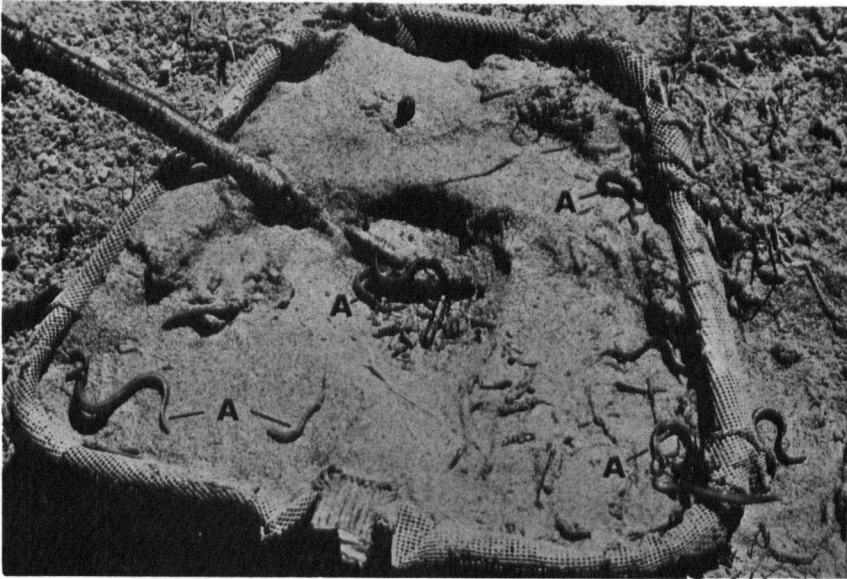


Fig. 10 A standard scoop of substrate with some sand removed to show the ammocoetes (A) at the surface.



Fig. 11 Method used to collect adults and large larvae above a riffle area. Electric shocker being used.

Adults spawning in nests were captured with a large scoop (Fig. 9-B) that was quickly drawn over the nest removing the lampreys and gravel. Particular care must be taken on bright sunny days to move slowly but to perform the scooping operation quickly as the animals are easily frightened at this time.

RESULTS AND REVIEW OF LIFE HISTORY

A. Review of the Taxonomy of the British Columbia Lampreys

1. Identification of Adults

By Dentition

The differentiation between adults of Lampetra planeri and Entosphenus tridentatus is facilitated by the presence of blunt degenerate teeth in the non-parasitic Lampetra while the parasitic Entosphenus has sharp rasping teeth (Fig. 12 and 15). Figure 15 shows the variation in the cusps on the lateral teeth of Entosphenus. The schematic drawings (Fig. 13 and 16) show the difference in number and position by dentition that appears commonly in the two Salmon River species. The supraoral lamella of Entosphenus has three cusps; Lampetra has only two, while the infraoral lamella in the former has 5 cusps, but 7 cusps in the latter. Entosphenus has 4 to 5 lateral teeth while Lampetra has three.

By Myotomes

The adult myotomes were counted under a dissecting microscope. The adults had to be skinned and stained with eosin on occasions when counting from external features was difficult. The count was taken between the last gill cleft

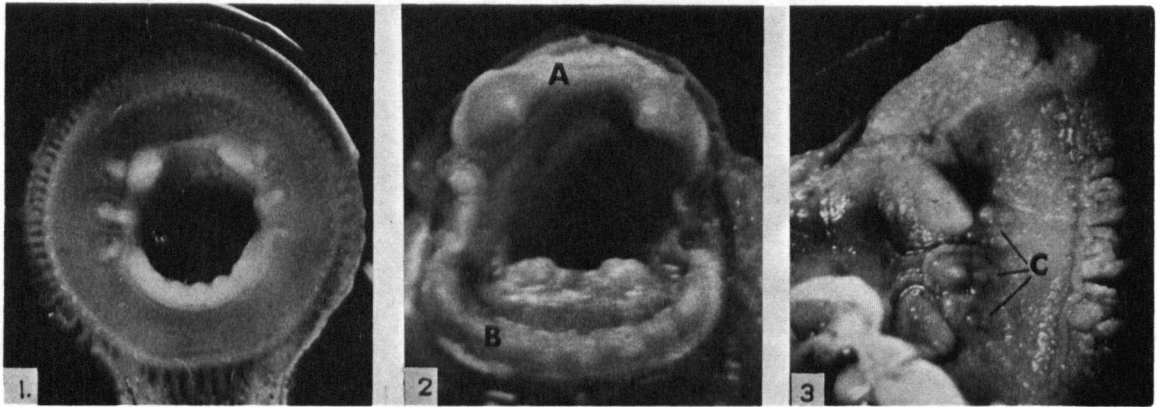


Fig. 12. Buccal disc and tooth morphology of the non-parasitic lamprey *L. planeri* from the Salmon River. Supra-oral(2A) and sub-oral(2B) lamella with the disc and lateral teeth removed. Saggital section(3) through the buccal disc showing the lateral teeth, each with two cusps (3C).

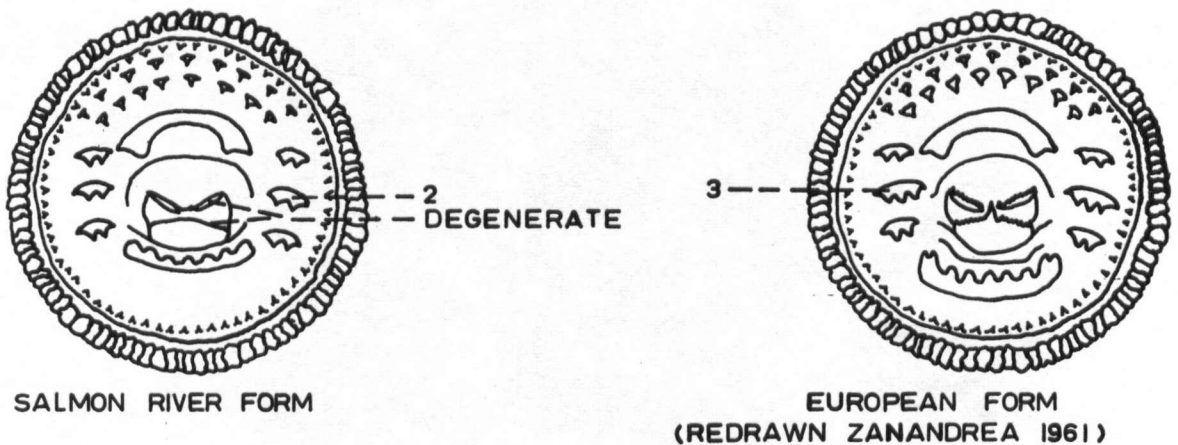


Fig. 13. Schematic drawings of the buccal disc of the Salmon River and European *L. planeri*.

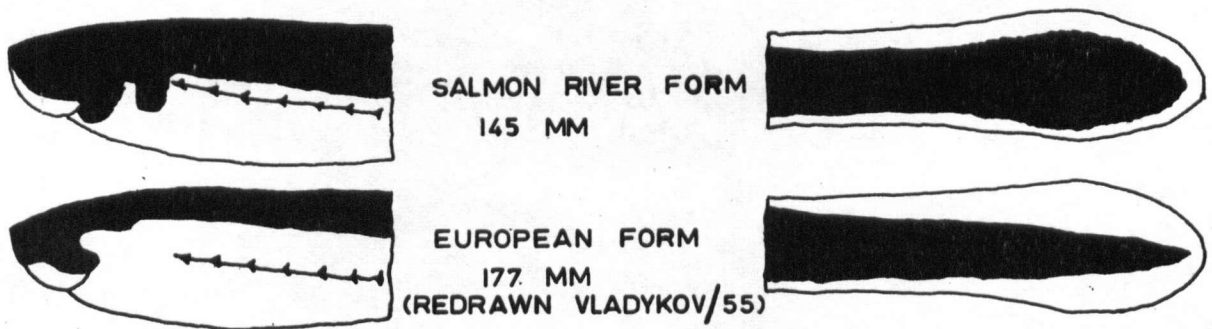


Fig. 14. Comparison of British Columbian and European ammocoetes of *L. planeri* by areas of pigmentation.

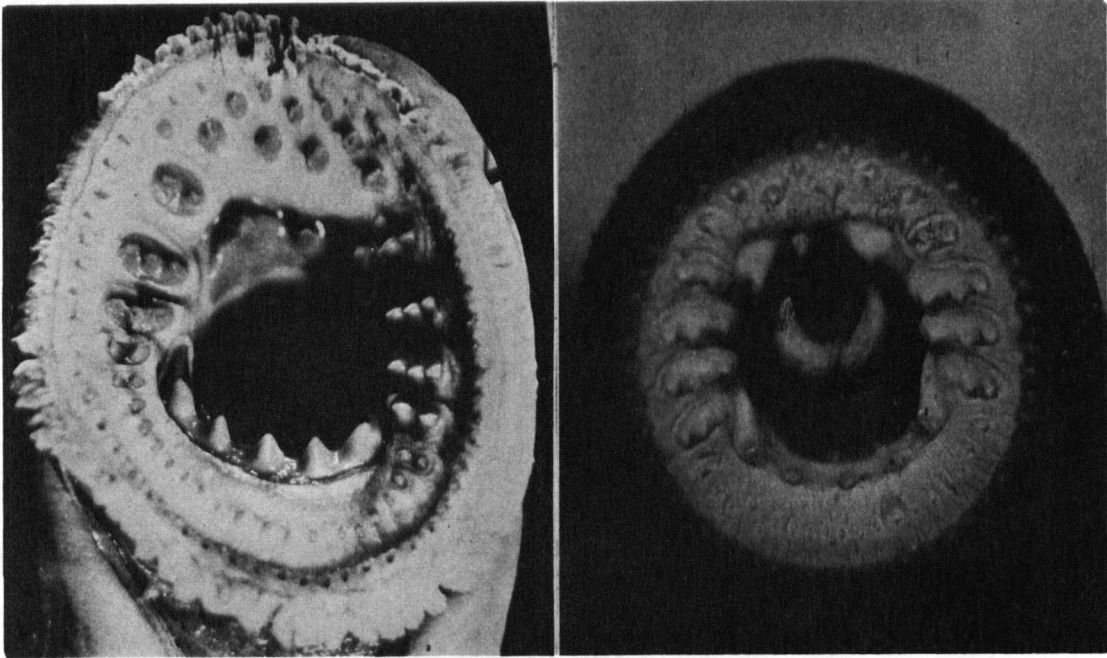


Fig. 15 Buccal disc and tooth morphology of the parasitic lamprey E. tridentatus from the Salmon River.

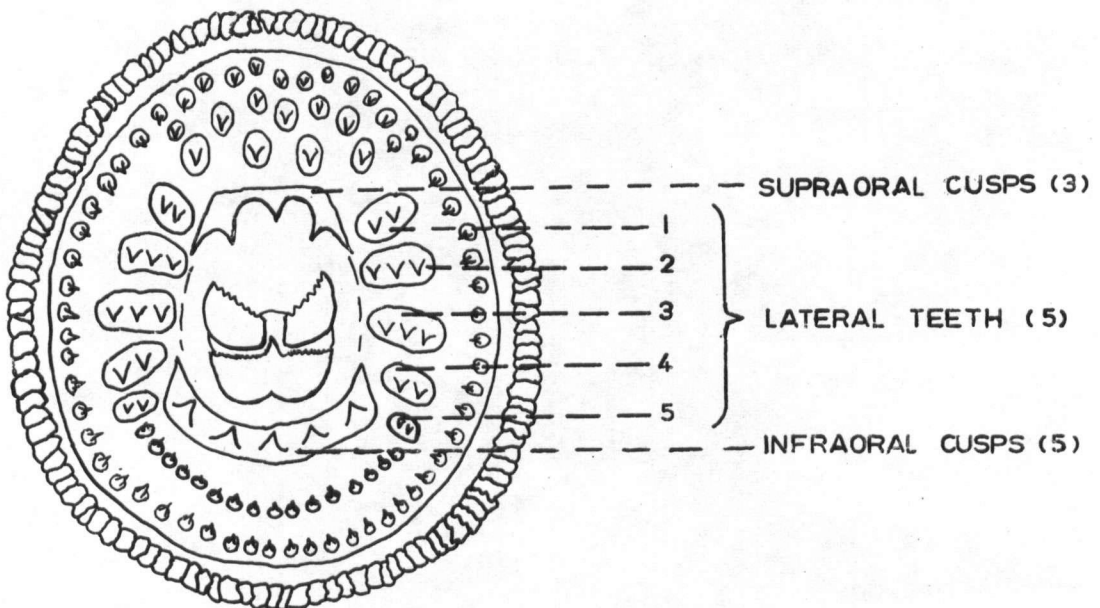


Fig. 16 Schematic drawing of the disc and dentition of E. tridentatus from the Salmon River.

and the anterior edge of the urogenital opening.

There was a significant difference in myotome counts between the adults of the two species (Fig. 17 mean L. planeri 63.9 and E. tridentatus 66.9; $T = 10.53$, $P < .001$). This represents a higher myotome range 62-69 for L. planeri compared to a 60-65 range reported by Hubbs (1924) and Carl et al. (1958).

2. Identification of Ammocoetes

Identifying ammocoetes of British Columbia lampreys has been very difficult as a myotome count has been the only criterion used (Carl et al. 1959). All ammocoetes were skinned on the right side and counts made under the microscope. Skinning was accomplished by making two parallel cuts along the side of the animal from the last gill opening to just past the vent. Then the skin was stripped from the side with forceps. Staining the ammocoete connective tissue with eosin helped in making accurate myotome counts. Vladykov (1955) reported that on the average ammocoetes possessed 1 or 2 fewer trunk myotomes than adults. Counts of myotomes are most difficult on adults. Adult Entosphenus do not increase their myotome numbers on reaching adulthood as is common for Lampetra in the Salmon River and in other species reported by Vladykov (1955). Figure 17A and 17B shows the range of variation in the myotome number for the adults and ammocoetes from the Thompson-Nicola system (exclusively Entosphenus) and those of the Salmon River, a mixed population containing mainly Lampetra (90-95% of spawning adults). Myotome counts on 45 ammocoetes of Entosphenus (range 65 to 71, mean 67.5) showed a highly significant difference from Lampetra (range 59 to 65, mean

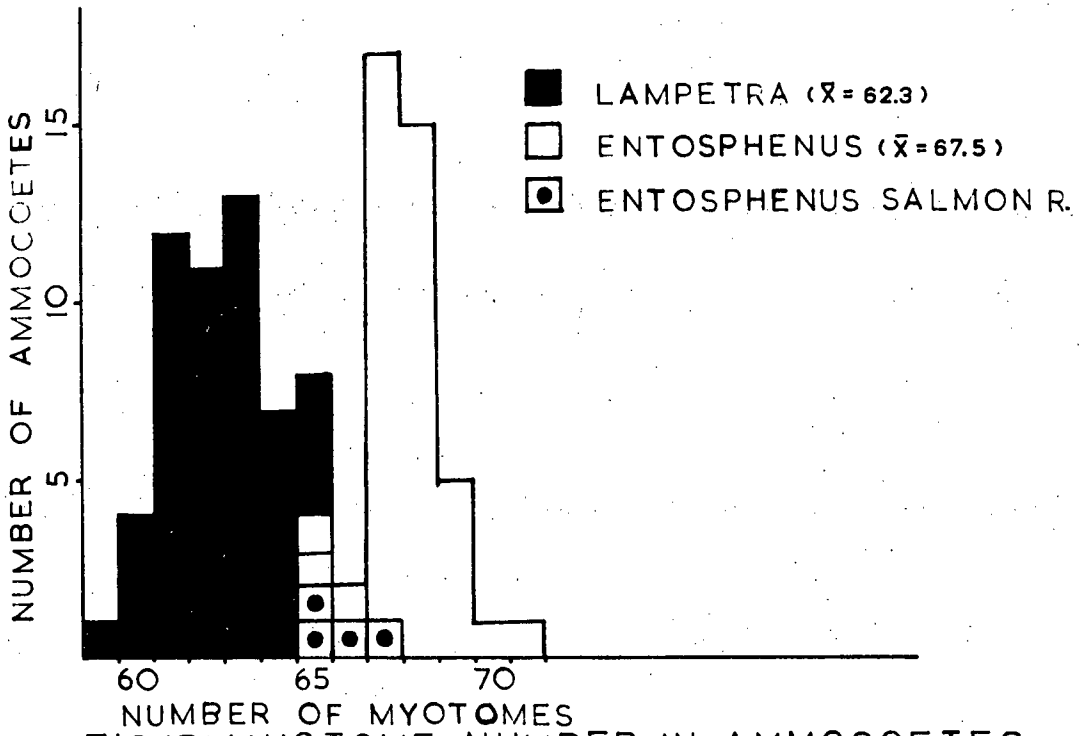


FIG.17A.MYOTOME NUMBER IN AMMOCOETES

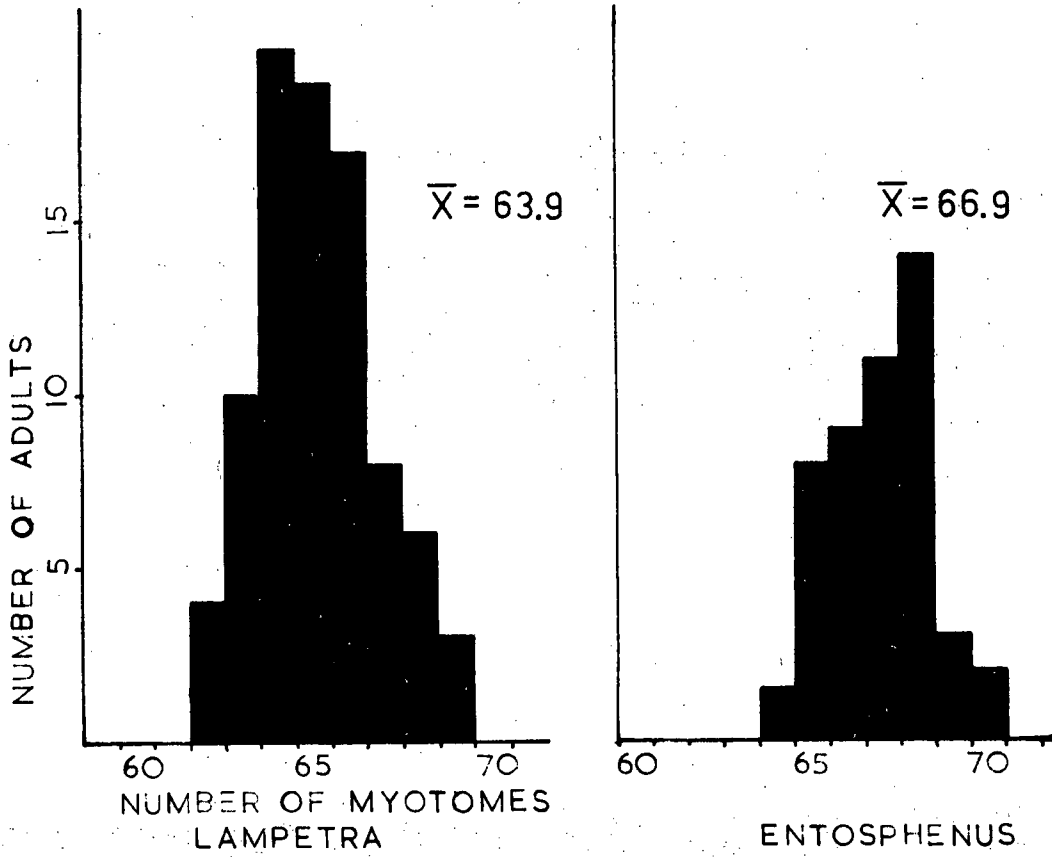


FIG.17B.MYOTOME NUMBER IN ADULTS

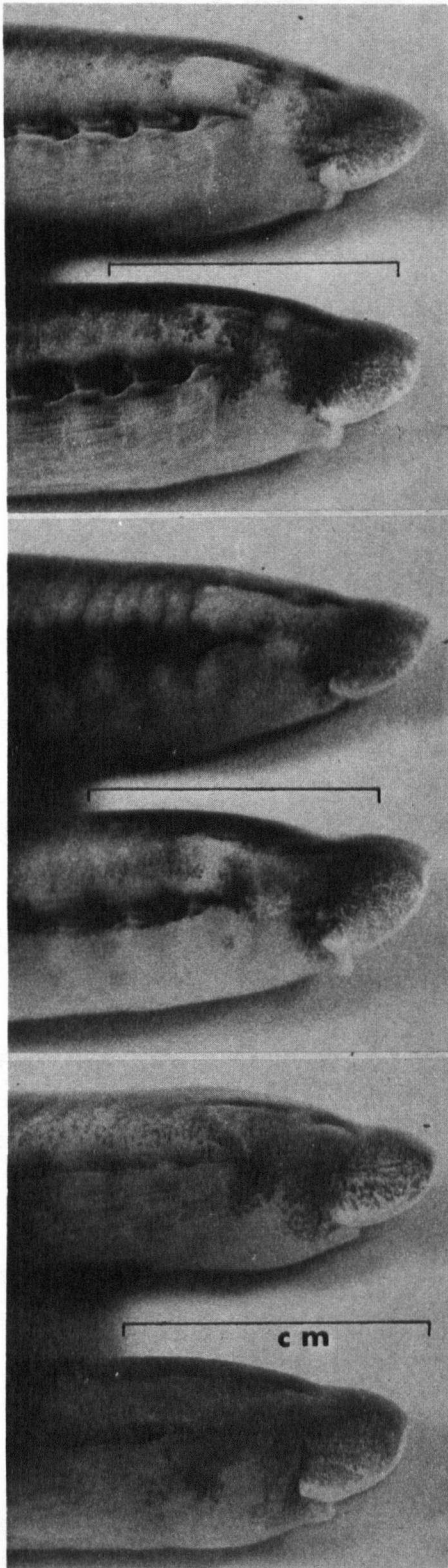
62.3) $T = 19.3$, $P = .001$, 95 df.

The separation of the individuals with overlapping myotome numbers was accomplished by comparing the areas of the ammocoetes covered by melanophores (Fig. 18). Vladykov and Follett (1958) maintain that, "one of the most important characters for the identification of larval lampreys is the pigmentation of the head and tail region." Care must be taken to have the melanophores in the same stage of contraction to make this method consistent. The increase in melanophores on two areas of the head of Lampetra is a distinct characteristic in separating the larger ammocoetes of the two species. Small ammocoetes do not show the same distinct differences and can not be separated on the basis of pigmentation. Figure 17B represents myotome counts of Lampetra from the Salmon River and Entosphenus from the Nicola, Thompson, and Cowichan Rivers. Four of the ammocoetes with higher myotome counts from the Salmon River ammocoetes proved to be Entosphenus when melanophores were observed (Fig. 17A).

3. Nomenclature

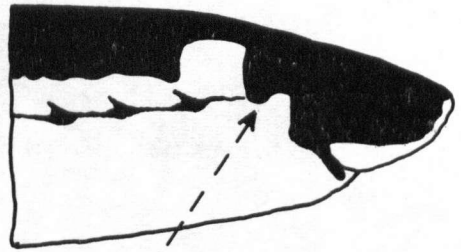
A key to Western North American lampreys appears in Carl et al. (1958). The identification and nomenclature of Entosphenus tridentatus and Lampetra ayresi produces no difficulty for the adult but separation of the ammocoetes is not possible from the myotome counts given. The nomenclature applied to L. planeri showed much discrepancy with the European form so the original naming was traced. The first description of the North Western Brook lamprey was attempted by Creaser & Hubbs (1922) and was based on the description of Regan (1911)

ENTOSPHENUS TRIDENTATUS



NICOLA RIVER

100 mm.

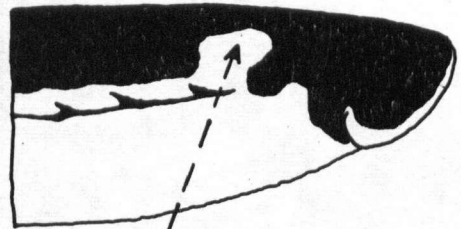


101 mm.

Melanophores reduced below the gill slits

COWICHAN RIVER

95 mm.



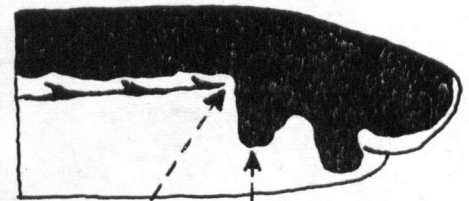
85 mm.

Clear area above 1st gill slit

LAMPETRA PLANERI

SALMON RIVER

96 mm.



88mm.

No clear area above 1st gill slit

Melanophores extended below gill slit

Fig. 18 Shows how the melanophore pattern can be used to distinguish large ammocoetes of E. tridentatus from L. planeri.

from specimens taken from Europe, Siberia, and Japan. The name Lampetra planeri was adopted because the middle lateral tooth has two or three cusps, according to Regan (1911). Since this time the specimens with two cusps have been renamed L. mariae and L. reissneri in Europe and Asia while L. wilderi applies in Eastern North America (Berg, 1931). However for the lampreys from Western North America the specific name planeri has been retained. A re-examination of the genus Lampetra would seem to be desirable.

4. Comparison of European and British Columbia L. planeri

The number of cusps on the middle lateral tooth of the Salmon River L. planeri ranged from none to three well developed cusps (Fig. 12). Three individuals from the Salmon River possessed two cusps of the middle laterals on one side and three on the other side, while on two others the laterals were missing completely. However, two cusps on the middle lateral tooth was the average number for adults from the Salmon River and Sweltzer Creek while adults from Port John Creek had an average of three cusps. The middle lateral tooth cusps always numbered three in the European L. planeri. The myotome number of the adult European L. planeri varied from 60 to 65 (mean 62.3) Vladykov (1955), while its ammocoetes ranged from 58 to 64 (mean 60.7). The Salmon River population had higher counts of myotomes, 61 to 65 (mean 63.4) for adults while the ammocoetes had 58 to 65 (mean 62.3). The melanophore area of the head and tail of the European L. planeri ammocoete was greatly reduced compared to areas of the North American form (Fig. 14).

There seemed to be a greater degree of sexual dimorphism in the European form than in the Salmon River form because dorsal fin height, eye diameter, and buccal disc diameter showed only slight difference with sex compared to marked sexual differences in the European forms (Vladykov, 1955).

B. Adult Life

1. Duration of Adult Life

Adult life commences when metamorphosis is complete and when the adult morphological characteristics appear. Metamorphosis is the transition period when the ammocoete undergoes drastic body changes such as the formation of a sucking buccal disc with teeth, formation of functional eyes, development of two dorsal fins, atrophy of the endostyle, enlargement of the gonads, and abandoning of filter feeding, plus many other physiological and morphological changes. From length-frequency data adult life apparently starts after at least five years of larval life. Further morphological changes take place during transformation and adult life for at least one year. Leach (1940) is of the opinion that there is a rest period prior to metamorphosis, when the ammocoete does not grow in length. Stauffer (1962) found evidence of a longer life cycle than was indicated from length-frequency data when he allowed a Sea Lamprey population to go to extinction. A rest period has been found in all cases examined experimentally. It is highly likely therefore that the Salmon River population and other British Columbia lampreys are at least one year older than is indicated from the length-frequency analysis of the population.

Lampetra

Transforming ammocoetes appear in the collections from the Salmon River during August to November, with fully transformed adults appearing on the spawning gravel in April. No specimens of transforming adults have been found in the river from December to April so little can be said about the exact time adult life starts. However, one partly metamorphosed female was obtained as late as April 29. The buccal disc was incompletely formed and no female secondary sex characteristics were present. This specimen was kept in an aquarium (16-20°C). By the first of June the abdomen was distended from the enlarging eggs and a pseudoanal fin had developed. However, the animal remained buried in the gravel until the sexual development was complete, suggesting that transforming adults burrow deeply into the gravel during the winter and leave the gravel only when sexual maturity is completed in the spring. Collection from the Salmon River of four adults nearing sexual maturity but still burrowed in the gravel was accomplished by using an electric shocker in May 1962. These specimens had just attained sexual maturity as one female had not shed her eggs and her body was distended. When placed in an aquarium, communal spawning started within two days. Hence adult life appears to last for only a matter of one or two weeks before spawning. Females usually die within a week of laying all eggs, but they can live for one month at low temperatures (8-14°C) as will be described in the post spawning period observations. Males may live as long as two months after spawning.

Entosphenus

The Brook lamprey achieves sexual maturity immediately after transformation, spawns and dies; but the parasitic lamprey, Entosphenus, migrates to sea at the start of adult life. The migration to sea takes place during the spring and summer in British Columbia. Entosphenus begins to feed parasitically on the blood of fishes upon entry to the sea or lake and develops a large abortive intestine. In the Salmon River population metamorphosis probably occurs during the summer and fall of the fifth year of life or later. Specimens of transforming Entosphenus were taken from the Big Qualicum River during August 1961 and from the Nicola River in December of the same year, indicating that migration downstream occurs during the summer following transformation. Small mature adults apparently migrating downstream were collected on the irrigation screens of the Nicola River during August.

From the size of adults attached to fish in the Strait of Georgia and in Cowichan Lake it can be deduced that parasitism begins during the spring and summer following migration to the sea or lake. No evidence exists on the Pacific Coast for parasitism by the lamprey during the first year of adult life but they possibly feed on species of fish that are slow swimming and bottom feeders rather than on salmonids which are preyed upon by large lampreys. The size of scar marks on hosts and the size of specimens collected indicate a further stay of one year in the sea with migration upstream commencing during the summer and fall of the first or second year of sea

or lake life. Precocity is suggested by small sized members of the populations in the Salmon River and Nile Creek (Vancouver Island). Migration upstream may occur one year in advance of spawning. Applegate (1950) suggests that the Sea Lamprey of Eastern North America spends two years of adult life in the sea. Recent diving observations by Mansuet (1962) suggest that the Sea Lamprey, upon migration to the sea, may spend the winter of the first year in the estuaries near the shore feeding on small bottom and shore fishes such as the menhaden. Atrophy of the mid-gut and intestine occurs upon entry to fresh water, and no feeding occurs during the year preceding spawning.

Some specimens of Entosphenus spend the winter and early spring among rocks and gravel in the upper reaches of British Columbia streams. One specimen was collected during December, 1961, at Merritt on the Nicola River while the writer was turning over some large boulders. A short migration to locate spawning gravel is suspected in April to June, when the temperature rises above 10°C (from observations on the Salmon River). Few actual observations of Entosphenus spawning have been witnessed and apparently no descriptions of spawning behaviour occur in the literature.

2. Length of Adults

Ammocoetes and adults were measured to the nearest mm. by placing the animals over a plastic ruler and reading the distance from the tip of the oral hood to the tip of the tail. A shrinkage of 3 percent occurred after a period of preservation of one month from the initial measurements.

The live animals were first measured after anaesthetisation with MS 222 (0.2 gr. per liter).

Lampetra

Adult lampreys from the Salmon River are much shorter in length than those of Smith Creek and Hooknose Creek (see Fig. 19A). The mean length is 120 mm. for the Salmon River and 143.8 mm. and 167.2 mm. for the other streams respectively. Schultz (1930) collected 126 adults (mean 110 mm.) near Seattle, Washington. These Lampetra are much smaller than any of the populations in British Columbia. Hardisty (1944) found considerable variation in the size of adults from different streams and even from different parts of the same stream for L. planeri in England. He found a difference of 20 mm. between means of some populations but the mean over a ten year period was 132 mm.

The variation in length over a wide range (83-169 mm.) in the Salmon River population seems to be a general characteristic of lamprey populations as reported by Applegate (1950) and Zanandrea (1954). Hardisty (1961a) suggests that this spread in size represents mixed spawning classes as is also indicated from the length-frequency data. Two or three modes may occur in separate age classes. However nutritional or environmental effects on length was indicated by the great range in length in L. planeri in the Salmon River (Fig. 24). The upstream adults are significantly smaller in length than the downstream individuals which suggests differences in nutrition.

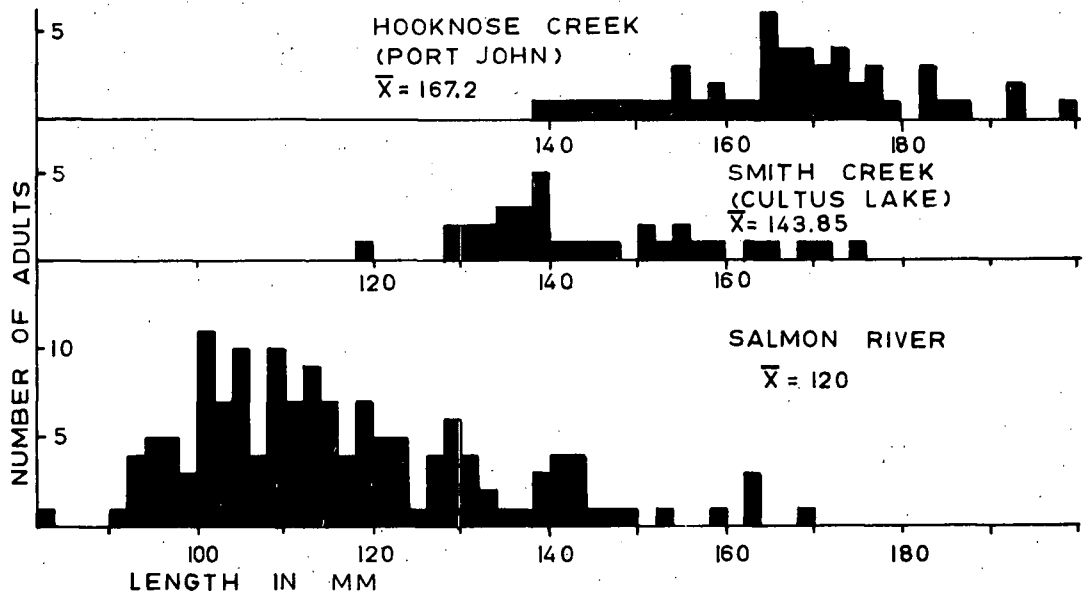


FIG.19A. LENGTH-FREQUENCY DIAGRAMS OF ADULT LAMPETRA PLANERI.

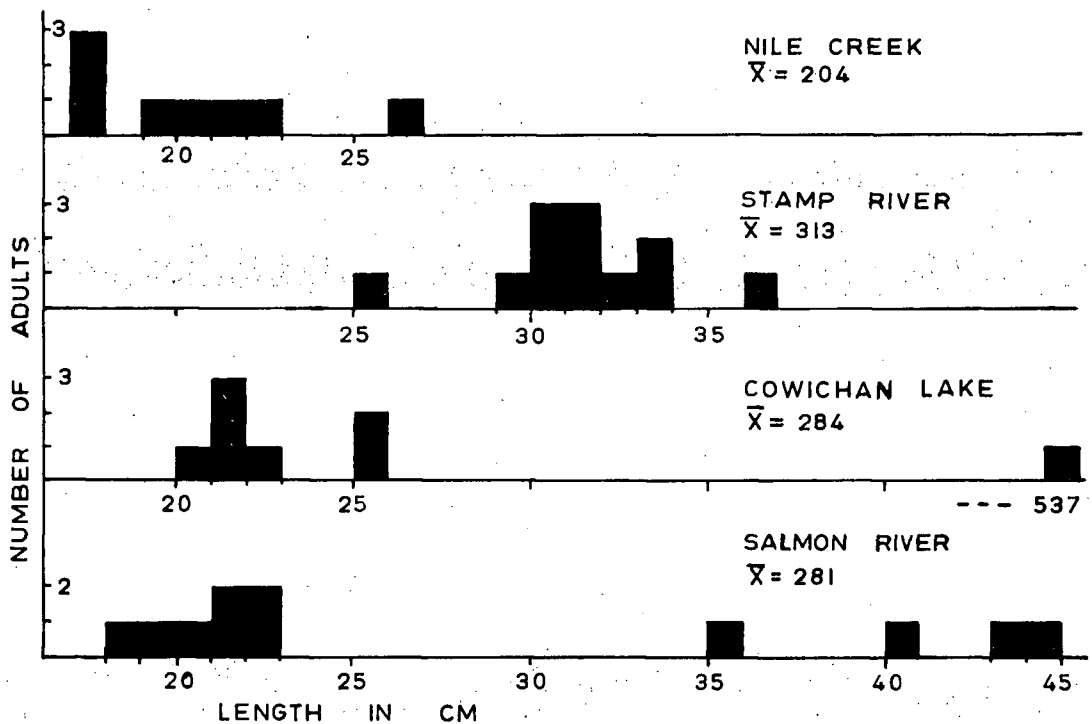


FIG.19B. LENGTH-FREQUENCY DIAGRAMS OF ADULT ENTOSPHEMUS TRIDENTATUS.

Entosphenus

The Entosphenus spawning population on the Salmon River also shows a wide range in size when compared to the migrating adults collected on the Stamp River. Since this species is anadromous and parasitic there is greater nutritional variation than might be expected in the sedentary Brook Lamprey. The variation in length is from 193 to 450 mm. with a mean of 281 (See Fig. 16 & 19). Inadequate sample size from this rather small percentage of the Salmon River lamprey population (5-10%) limits the conclusions that can be drawn, but there is an indication from the histogram (Fig. 19) that two distinct size groups may be present. It is possible that some individuals return from the sea prematurely

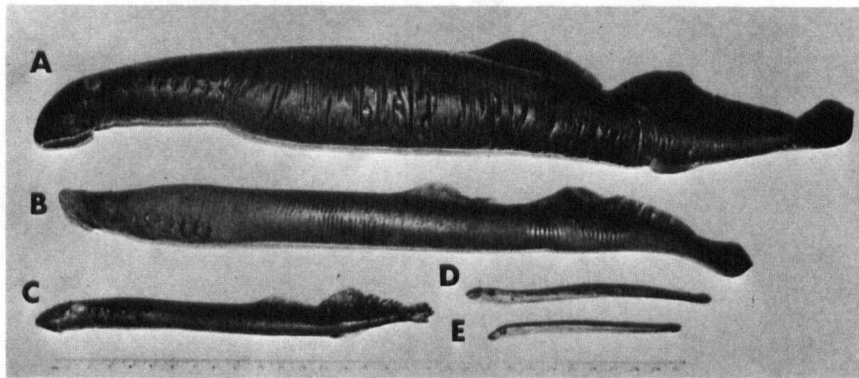


Fig. 20: Differences in sizes of Entosphenus
 A. A distended 410 mm. specimen from Port John
 B. A 330 mm. migrating adult from the Stamp River
 C. A 183 spawning female from the Salmon River
 D. Metamorphosing adult from Nicola River
 E. Metamorphosing adult from Big Qualicum River

because they may migrate to the Fraser River or estuaries, while the larger size adults may spend a greater number of years living parasitically on fishes in the open sea.

Examination of specimens caught in the Strait of Georgia suggest the possibility of a small size group (Fig. 19).

The size of lamprey scars on whales (Pike, 1951) and from one large specimen (570 mm.) taken from the mouth of a fur seal many miles off Cape Flattery, suggests that larger lampreys go many miles into the open ocean.

Carl et al. (1959) suspect that a dwarf race of Entosphenus is present in the Cowichan River system. An analysis of 6 specimens attached to trout from Cowichan Lake showed a mean length of 226 mm. These animals were probably in their second year of adult life as indicated from their gonads and intestines. They possibly represent a land-locked race of lamprey that spends its entire life in Cowichan Lake and is similar to the land-locked lamprey of the Great Lakes. However, one specimen 537 mm. in length was collected attached to a log during June of 1961. On examination it was determined that this represented a migrating adult returning from the sea (Fig. 23). Carl (1953) reported a large migrating run of Sea Lamprey that formerly ascended Scutt Falls in August. No reports of this large run have been made in recent years.

A landlocked parasitic race of lamprey may be present in the recently impounded Elsie Lake near Alberni (D.R. Hurn, personal communication). Hurn reported a 76 percent incidence of lamprey parasitism on the trout population in this lake in May (Table 2). His netting of trout showed an

increase of fresh lamprey scars during the spring and early summer. Recruitment from the sea has been cut off by the impoundment and a landlocked race is left to continue the cycle. The size of the scars indicate a dwarfed race of lamprey or immature size length. A similar dwarf lamprey occurs in an impoundment in California (Coots 1955).

The greater length of migrating anadromous Pacific lamprey that ascend Hell's Gate on the Fraser, Moricetown Falls on the Bulkley, and Bridge River Rapids and Stamp Falls on Vancouver Island seem to agree with Lack (1954) who states that greater length and fecundity is associated with longer migratory journey. Five specimens obtained from Nile Creek, a short, small stream, have a mean size of 217 mm. The reduction in size and fecundity of the landlocked lampreys of the Great Lakes gives added support to this theory.

The length of the adult Entosphenus of the Nicola-Thompson system was not determined. Recently transformed adults of mean length 122 mm. were collected during December 1961 and April 1962. One specimen 300 mm. long collected in December 1961 represented the wintering migratory year class which would spawn the following spring. Large adult size of lampreys is suspected from the greater length of the ammocoetes collected and from the physical and chemical properties of the Nicola River system.

3. Parasitic Life of Entosphenus tridentatus

Recently transformed Entosphenus feeds parasitically soon after transformation and migration to the sea or lake. Small Pacific Lampreys were collected in June attached to

Table 2. Incidence of lamprey scars on trout in Elsie Lake.
D.R. Hurn, 1963, British Columbia Fish and Game
Branch.

Date	No. of fish sampled	Percent old & new scars	Percent old scars	Percent new scars
20 May 59	47	76.63	2.13	74.5
6 May 60	80	57.5	27.5	30.0
6 June 60	24	66.67	29.17	37.5
13 July 62	110	40.91	13.64	27.27
3 April 63	19	52.63	21.05	31.58
5 June 63	117	15.20	8.77	6.43

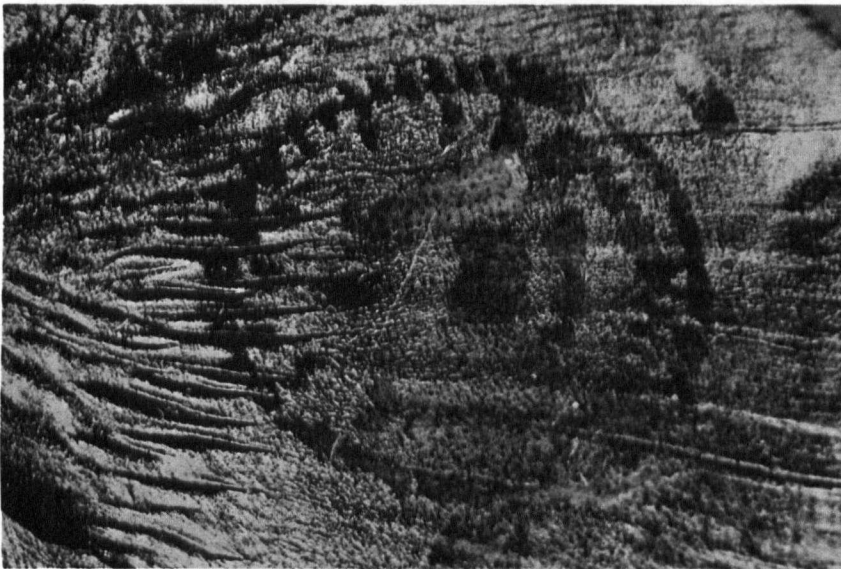


Fig. 21 Lamprey scar on the operculum of a 6 lb. pink
salmon caught near Sooke August 21.

shore feeding and spawning herring in Howe Sound. Predation is common on salmon in the Gulf of Georgia and the Strait of Juan de Fuca during June to September (Fig 21). Numerous reports of lamprey attached to herring bait trolled from a line have been reported from the same area at this time. Landlocked Pacific Lamprey migrate to the lakes where they begin to feed on the resident trout population. Hurn (personal communication) indicated a high incidence of parasitism (15-76 %) from analysis of trout bearing scars in Elsie Lake during the March to July period. In Cowichan Lake the period of greatest predation on trout extended from January to June (Fig. 23 and Table 2).

Wigley (1959) reported that Sea Lamprey of Cayuga Lake, New York, reached a peak of parasitism during August and September with an incidence of 66 to 70 % of the trout bearing wounds. He found the greatest number of lamprey scars on the largest trout, but found no preference by lampreys for trout of a certain size. Analysis of covariance revealed that the lake trout with the greatest number of lamprey wounds are the thinnest, and smaller trout suffered more severeweight loss than did large trout.

Lampreys locate prey by vigorous swimming and orientation toward a chemical stimulus released into the water from the prey (Kleerkoper 1958). The chemical stimulus is perceived by the olfactory organ located in the lamprey's single nostril. The final location of the prey is accomplished by an electric field that surrounds the head region of the lamprey (Kleerkoper 1958). This electric field (200-300 μ volt)

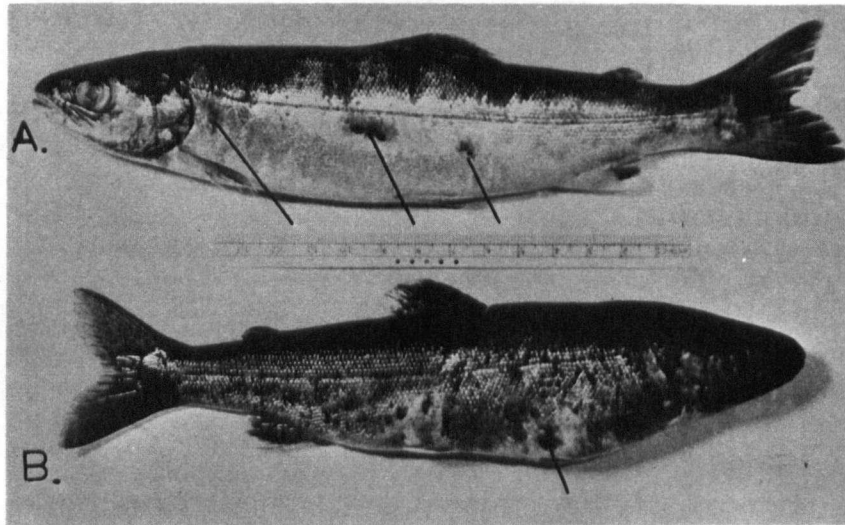


Fig. 22 Rainbow trout (*Salmo gairdnerii*) gill netted in Elsie Lake showing lamprey scar marks. A- pointers indicate old scars. B- fresh scar.

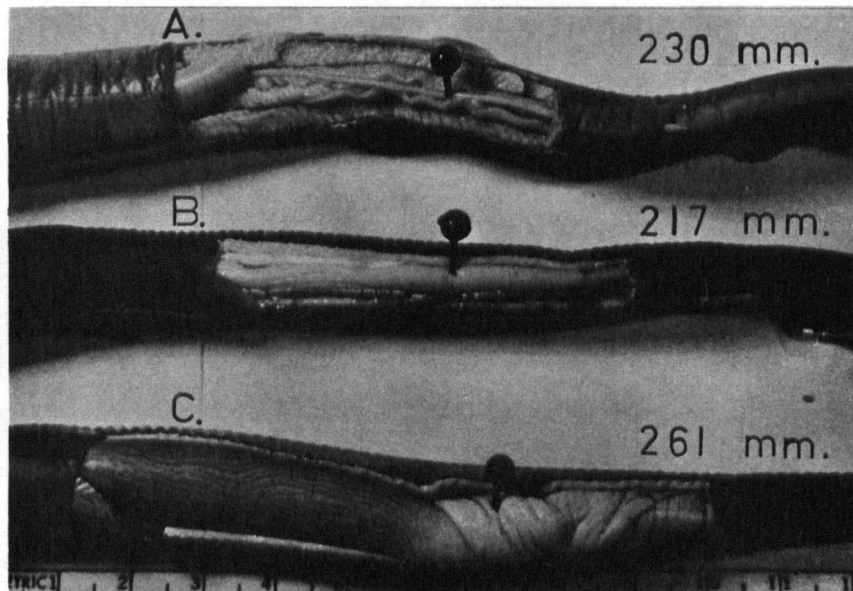


Fig. 23 Ventral view of intestine (pin insertion) of adult *Entosphenus*. A- Spawning male, Nile Creek, June, complete atrophy. B- Female one year prior to spawning, Cowichan Lake, January, feeding reduced, atrophy started. C- Male, Cowichan Lake, January, actively feeding.

comes into use 5-10 cm. from the prey and enables the lamprey to make final attachment to the prey. Suction and the horny teeth enable the buccal disc to be firmly attached. A hole is rasped through the skin and into the flesh by a toothed tongue and the blood and body juices are extracted by suction. A powerful anticoagulant is injected that keeps the blood flowing, helps to corrode the flesh, and thus enlarges the wound (Kennedy 1956).

Duration of Attachment

Carl (1953) reported that actively feeding Entosphenus 200 mm. in length from Cowichan Lake kept in a tank attached to cutthroat trout, brown trout, char and coho salmon for a period of one day to several weeks. Kennedy (1956) reported that Sea Lamprey in the Great Lakes remained attached to prey for at least one day to a week.

Hurn (personal communication) found that Entosphenus in Elsie Lake attached most frequently below the lateral line and posterior to the opercule (Fig. 22). Wigley (1959) analysed lamprey scars and found 49% in the pectoral, 25% in the prepelvic, 23% in the pelvic, and 5% in the head region. Wigley found few scars above the lateral line of the prey. This seems to indicate that the lamprey attacks the fish from behind and below in the region very near the heart.

No dead or dying fish have been reported from lakes or the sea as a result of lamprey attacks in British Columbia. However, it is evident that the surviving and attacked fish are seriously weakened. Kennedy (1956) found that Sea Lamprey in aquaria killed their prey in most cases.

41

4. Sex Ratio and Length of Spawners

Lampetra

The overall sex ratio for the Salmon River proved to be nearly even 1.2:1 for 1960-1963 (Males/females see Fig. 24). Schultz (1930) recorded the sex ratio at 2.32:1 for the same species in Washington. The sex ratio in the upstream and downstream samples is significantly different, as there is a larger proportion of females downstream, 1:2, and a larger proportion of males upstream, 2.5:1 (Fig. 24D).

There is also a significant difference in lengths between males (mean 113.4) and females (mean 126.8 $t = 3.1$ $p = >.01$) for the adults collected during the spawning season (Fig. 24A). Schultz (1930) found the opposite relationship, the males were larger than the females (means of 112 and 107.8 respectively). The effects of sex and stream location are confounded on the Salmon River. The upstream individuals of both sexes are smaller and males preponderate, while downstream the animals of both sexes are larger and females are the more abundant sex (Fig. 24B, 24C, and 24D). Hardisty (1961) found no significant difference between the length of the sexes for L. planeri in England over a ten year period.

These sex ratios and differences in size offer some food for speculation. The large size of the adults downstream suggests that there is a greater growth due to a better food source. Since the stream increases its flow downstream and the gradient decreases, more diatoms and other algae will be available to the larvae. The greater number of females in the

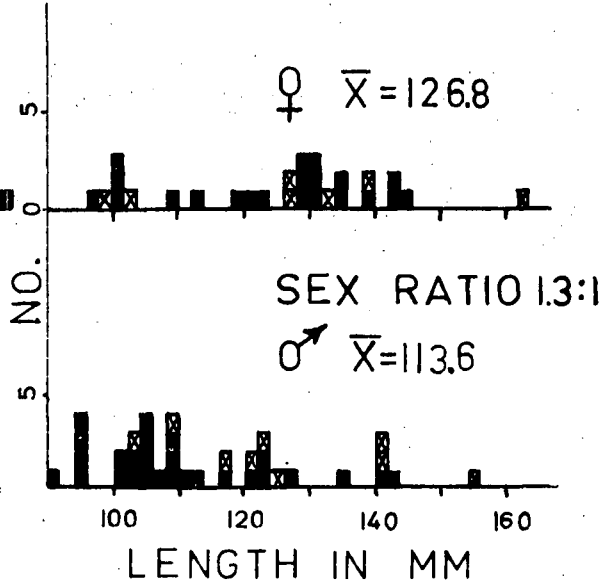
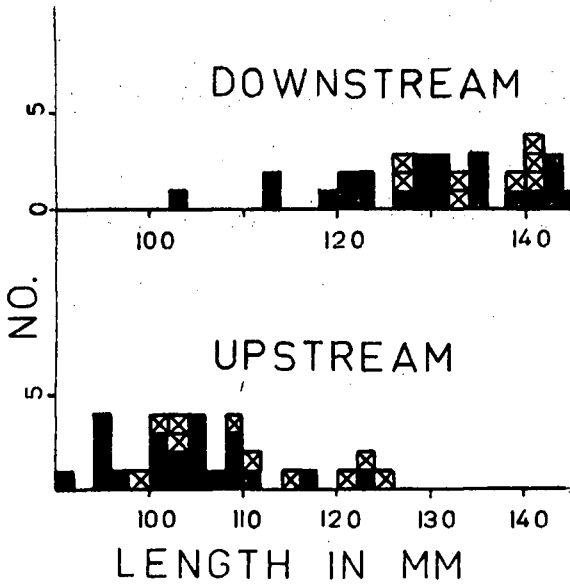


FIG. 24A. LENGTH DISTRIBUTION OF ADULTS.

FIG. 24B. LENGTH DISTRIBUTION OF SEXES.

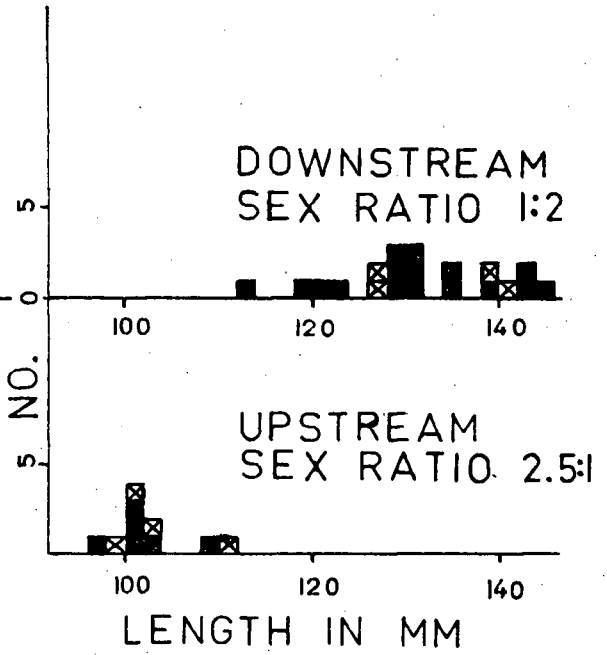
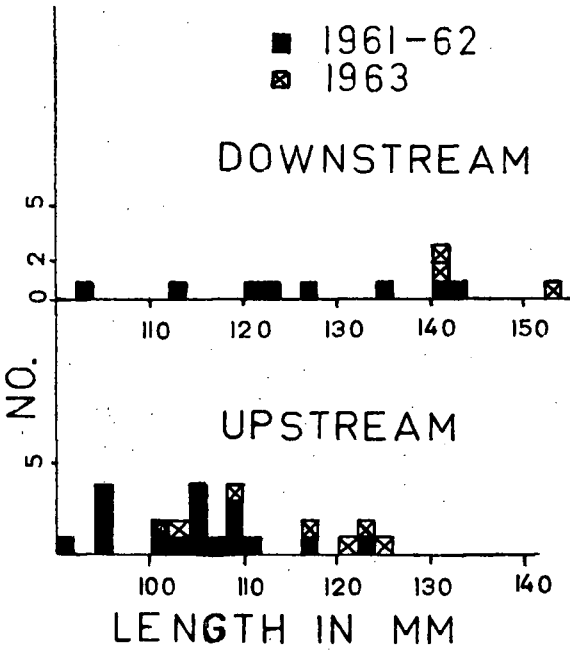


FIG. 24C. LENGTH DISTRIBUTION OF MALES

FIG. 24D. LENGTH DISTRIBUTION OF FEMALES.

FIG. 24. LENGTH-FREQUENCY DISTRIBUTION OF ADULT L. PLANERI IN THE SALMON RIVER, 1961-63.

downstream collection suggests a greater reproductive potential for the downstream population. This trend occurred in three separate years so it does not indicate sampling variability. Thus the downstream population would have a definite advantage in a greater number of eggs and a greater number of females.

Observations on adults held in aquaria at different temperatures offer some explanation for the sex ratio. At low temperature ($<10^{\circ}\text{C}$) the females are the aggressive nest builders and are active on the gravel, while the males are usually active for short periods only. Males spend most of the time hidden under rocks near the spawning area. Thus a greater proportion of the females would be sampled during the early part of the season when the temperature is cold. When spawning lampreys are transferred from a cold tank ($8-10^{\circ}\text{C}$) to a warm tank ($14-16^{\circ}\text{C}$) the behaviour changes. The male becomes the aggressive nest builder while the female spends more time away from the nest hiding under stones. Careful temperature analysis in the stream correlated with sex ratio throughout the season and at various times of the day should prove rewarding. There was a two degree higher temperature in the upper part of the stream in 1963, which would indicate a higher proportion of males and an earlier spawning in the upper reaches. However, spawning adults were first discovered downstream in 1961 and 1962. Upon more careful sampling during 1963 the upstream population was recorded spawning just as early, or earlier. Dead adults upstream and spawned out females indicate that the upstream population may have started to spawn earlier than the downstream population. If a spawning migration takes place in

the lower reaches of the river it seems reasonable that the females are more active in cold temperatures than the males and would thus move to the upper gravel areas of the downstream area (station 1) before the males. Thus they would appear on the nest first and in greater proportion than the males. As the season progresses and the temperature rises there would seem to be an increase in the number of males, as is the case. However, aquarium holdings of spawning adults (8-14°C) indicate that the males lived for at least six weeks after spawning started while all the females died within four weeks of collection. However, when adults are kept at higher temperatures (16-20°C) females still die first but males usually die within two weeks of collection. Therefore, behaviour of adults at different temperatures and longevity of each sex after spawning may effect the sex ratio of collections.

Hardisty (1954) analysed L. planeri sex ratio in many streams in England over more than ten years and reported great variation in different streams from year to year. Zanandrea (1961) and Hardisty (1961) found that the sex ratio upon reaching the adult stage was even but as the season progressed the number of males always outnumbered the number of females. Applegate (1950) and Surface (1897) found similar conditions for Petromyzon marinus.

Greater longevity of males was suspected by the above workers as a possible explanation for the greater number of males as the season progresses. Hardisty (1954) made weekly analysis of sex ratio throughout the season and found that

the smallest proportion of males was found in the last week of the spawning season. Hardisty (1961) found a distinct correlation between the sex ratio and the relative abundance. The years with the lower relative abundance were associated with a sex ratio of 1.8 or less while ratios higher than 2.2 were associated with greater numbers of adults. Similar correlations were reported by Applegate (1950a, 1950b) for P. marinus. Wigley (1959) found that when sea lampreys were abundant there was a higher proportion of males (3:2) and in years of low abundance the ratio was nearly 1:1. Hardisty (1954) suggests that the difference in sex ratio may be caused by environmental conditions as temperature and nutrition influencing the ammocoetes. Because of the long ammocoete life he considered the transformation year as being critical to the environmental effect on the sex ratio.

Entosphenus

Small sample size of the adults prevents drawing reliable conclusions about the population. From the 11 adults collected, the sex ratio is 1:1.8 which indicates a small population size according to Hardisty's theory. A sample of 12 migrating adults on the Stamp River revealed a 1:1 relation.

5. Fecundity of British Columbia Lampreys

The number of eggs in a one gram or less section of the ovary were counted and weighed (blotted dry). Then the remainder of the ovary was weighed and the total number of eggs obtained by simple calculation (Vladykov 1955).

Lampetra

A lack of mature but unspawned females from the Salmon River makes estimation of fecundity difficult for this population. Only two distended or nearly unspawned females were found. These contained 1136 and 1900 eggs. However, samples from Cultus Lake (Sweltzer Creek fence) produced estimates of fecundity between 2300 and 3000 while the Hooknose Creek population had a slightly higher fecundity with a mean of 2900 for the two populations (see Table 3). Hardisty (1960, 1963) and Zanandrea (1961) recorded egg production at 1000-2000 (mean 1500) for L. planeri in Europe. Zanandrea found a slightly higher number of eggs (mean 1850) for L. zanandrea of Treviso, Italy. Examination of spawned out dead adults from the Salmon River reveals very few eggs left in the body (1-7).

Hardisty (1961,1963) suggests reduced fecundity in dwarf forms is counterbalanced by a reduced mortality. In his 1960 paper he uses oocyte number in ammocoetes as a means of separating L. planeri from L. fluviatilis. He suggests that the brook lamprey evolved from the river lamprey by reducing its size and egg number but this is balanced by a reduced mortality associated with abandonment of anadromous migration. Hardisty estimated the oocyte number of L. planeri ammocoetes at 5000-10,000; during metamorphosis the greater part of the ovary atrophies as only 1000-2000 eggs are laid. Svardson (1949) has suggested that reduced fecundity in fishes is accompanied by an increase in egg size, but this does not occur in lampreys

(Hardisty 1963). Hardisty also suggests that precocious sexual maturity with reduced potential fecundity occurs in paired residual and andromous lampreys.

Rensch (1959) reported that in fish and reptiles increased body size results in greater egg number rather than larger eggs. However, Lack (1954) suggested that the extent of the spawning journey that the female undertakes and the number of primary oocytes present in the ovaries determines fecundity. The large lampreys with the greatest number of eggs could conceivably represent the individuals that migrate the greatest distance, thus compensating for the greater mortality with increased egg number.

Egg size of Lampetra is not very variable in the Salmon River. The Cultus Lake specimen was taken in the Sweltzer Creek fence so complete maturity of the eggs cannot be determined, but the eggs were not completely free from the ovaries which indicates immaturity.

Entosphenus

No mature unspawned Entosphenus were collected from the Salmon River but from size alone a high potential exists in part of the population. Analyses of unspawned Stamp River and Hooknose Creek populations reveal an average fecundity of 34,000 eggs with the highest number being 106,000 eggs in the largest individual examined. The sample size is not sufficiently large to warrant a regression analysis. Applegate found that the number of eggs produced increased quite rapidly with increase in total length, but that increased weight was more

directly proportional to egg production. Wigley (1959) reported a linear relation between body length and egg number for Cayuga Sea Lamprey. Hardisty reported a reduction in egg number in landlocked Sea Lamprey (mean 62,000, Vladykov 1951) from the parent Sea Lamprey that led an adromous life (mean 171,000 eggs, Vladykov 1951). Better collections of unspawned Entosphenus of the smaller size groupings from the Salmon and Cowichan Rivers may reveal from fecundity data a parallel to landlocked and estuarine races of Pacific Sea Lamprey.

The number of unspawned eggs in dead spawned out specimens of Entosphenus from the Salmon River were 35-135 eggs. Applegate (1950) reported a 5% retention of eggs at death. He noticed an increase in the relative percentage of unspawned eggs in females at the very end of the season in Lake Huron Sea Lamprey. Thus a greater reproductive potential exists for eggs that are produced by females at the beginning of the season.

The egg diameter of Entosphenus is very similar to Lampetra (Table 3). The eggs of both species are elliptical in shape; immature migrating Entosphenus possessing eggs that are one half the size of mature eggs. Ten eggs of Entosphenus were cross-fertilized with Lampetra and development proceeded to neurula but development stopped at this stage. This suggests that hybridization may be possible. From aquarium observations, male Lampetra were seen spawning with female Entosphenus when no Entosphenus male was available. Male Lampetra also took the spawning posture on male Entosphenus. However, Entosphenus usually prefer larger gravel size areas and deeper water for

Table 3. Fecundity and Egg Size of British Columbia LampreysUnspawned Entosphenus tridentatus

<u>Location</u>	<u>Date</u>	<u>Length</u>	<u>No. Eggs</u>
Stamp River	June 20, 1961	325	18,600
" "	" " "	310	10,100
" "	" " "	308	30,500
" "	" " "	375	35,400
" "	" " "	311	15,500
Hooknose Creek	May 1959	406	106,100
" "	" "	<u>262</u>	<u>24,800</u>
	Mean		34,400

Unspawned Lampetra planeri

Hooknose Creek	Feb. 1957	175	3,700
" "	" "	170	3,300
" "	" "	196	3,700
" "	" "	166	2,900
" "	" "	171	1,700
Sweltzer Creek	May 30, 1942	156	3,000
" "	" " "	153	2,900
" "	" " "	127	2,300
Salmon River	May 27, 1962	111	1,100
" "	" " "	<u>118</u>	<u>1,900</u>
	Mean		

Eggs remaining in spawned out females

Entosphenus

Salmon River	June 2, 1962	194	35
" "	" " "	204	135

Lampetra

Salmon River	May 27, 1962	100	4
" "	" " "	96	7
" "	" " "	110	6
" "	May 6, 1962	105	8
" "	April 20, 1962	130	2
" "	" " "	135	1

Table 3 continued and completed on next page.

Table 3 Fecundity and Egg Size of British Columbia Lampreys

Egg Size (ocular micrometer measurement of 10 eggs from each adult)

Lampetra

<u>Location</u>	<u>Date</u>	<u>Length</u>	<u>Width mm.</u>	<u>Length mm.</u>
Salmon River	June 3, 1962	110	1.07	1.12
" "	May 27, 1962	111	1.09	1.13
Smith Creek	June 9, 1961	138	.98	1.05

Entosphenus

Hooknose Creek	May 1959	406	1.09	1.24
Salmon River	May 31, 1962	214	1.09	1.14
" "	June 4, 1962	193	1.06	1.12
" "	June 20, 1962	204	1.09	1.17
Stamp River immature	June 20, 1961	375	.57	.69

nest building while Lampetra will occupy an area downstream from that preferred by Entosphenus. The difference in size seems to offer no obstacle as fertilization takes place in the water and sperms remain viable for some time as indicated from artificial fertilization of Sea Lamprey, Piavis (1960), Lennon (1955).

6. Spawning of Lampreys

(a) Methods of Analysis

Observations of lampreys spawning under natural conditions were made in 1961 and 1962 at weekly intervals when the stream was not flooding. Occasional observations were made during 1963. Surface current was measured over the nest using a cork attached to a 10 foot length of nylon line.

Laboratory observations of lampreys were made during the same period. Still water aquarium observations were undertaken in 1961 and 1962 when 7 gallon standard stainless steel aquaria were filled with 8 inches of water above a 3 inch layer of gravel which was obtained from lamprey spawning beds. Two air stones in each tank kept the water circulating and the tanks were placed in the east-facing window of a basement during the first two years and under fluorescent lighting near the laboratory windows during the last year. The temperature in these still water tanks ranged from 15°C to 20°C. When the temperature of the tanks in the basement window rose in the early summer they were removed from the window location to a table four feet from the window to prevent excessive heating.

Running water tanks were established in 1963 using

dechlorinated water flowing through a large 60 inches by 20 inches by 30 inches tank with 5 cm. of bottom type and 20 cc. of water above that. The tank had glass sides, wooden ends, and a metal bottom (Fig. 25). A continuous current was maintained in the tank (.2 to .35 feet per second) and with a flow of 300 to 400 cc. per second (Fig. 26). A temperature of 8 to 10°C was maintained throughout the spawning season. During April the temperature was 8°C, during June it was 10°C. One third of the bottom was covered with sand, the remainder of the tank was covered with gravel taken from the Salmon River. Current speed was tested with a Leopold Stevens current meter.

The second running water tank was constructed of white fiber glass over plywood with one glass side and a glass top. A small inflow of water (5-7 cm. per sec.) was maintained in order to keep the temperature between 11°C and 14°C. The water depth was 8 inches and 3 inches of spawning gravel covered the bottom.

Motion pictures were taken of the 1963 spawning, in order to analyse behaviour; 35 mm. photographs were taken throughout the time to analyse the positions and actions of the lampreys.

During the 1962 spawning season one of the wooden tanks 60 inches by 30 inches was darkened with black plastic on all sides which allowed only diffused and reflected light to strike the bottom of one side of the aquarium. The air stones kept the water circulating so that there was no temperature difference between the two sides of the aquarium.

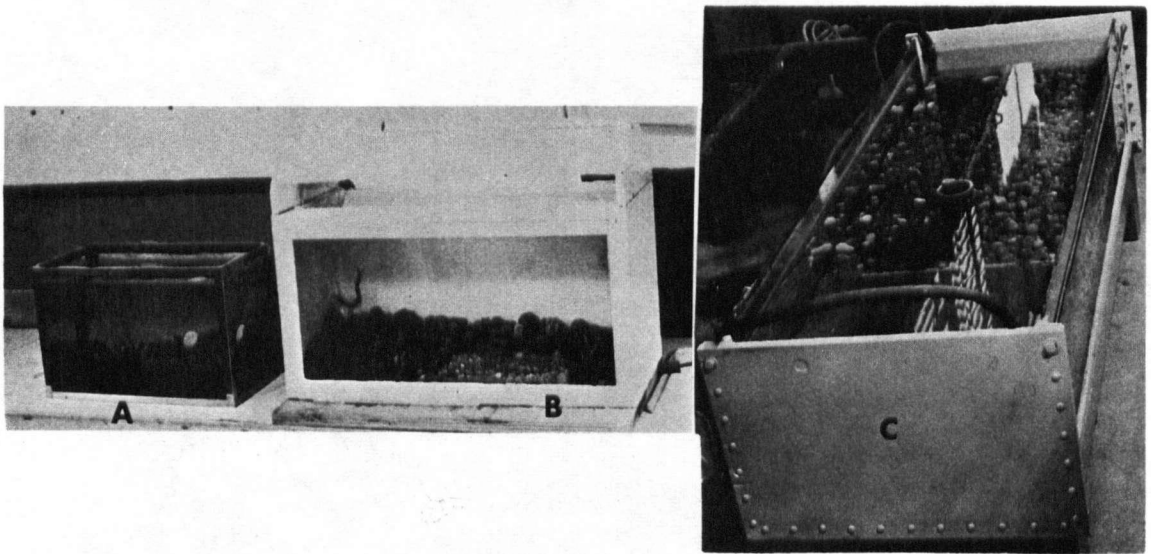
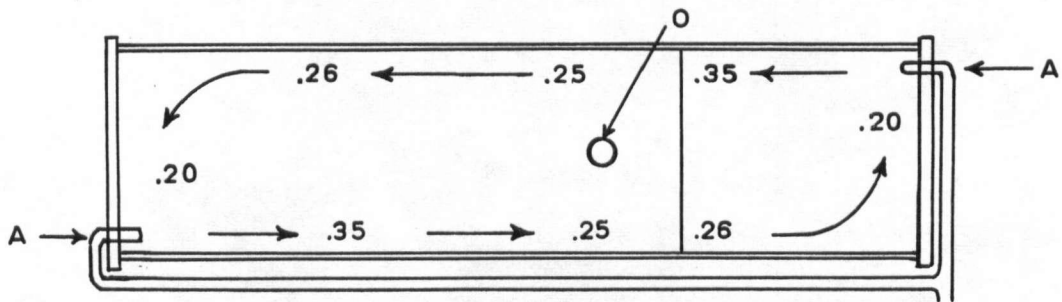
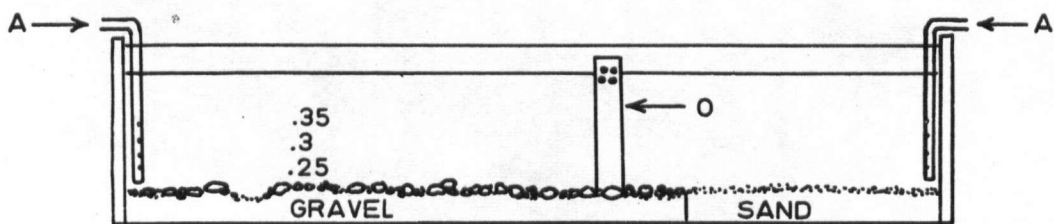


Fig. 25 Experimental spawning tanks. A (16-20°C.) contains still aerated water; B (11-15°C.) and C (8-10°C.) contain circulating water.



Top view of a spawning tank (C) showing current velocity in feet per second. A - water inlet; O - water outlet.



Side view of spawning tank (C).

Figure 26 Spawning tank (C above) (8-10°C.) showing current and bottom arrangement.

Another tank 20 inches by 40 inches had an aluminum partition separating the two halves of the aquarium, and gravel from the natural spawning bed was placed in the bottom of one and sand in the other. (Later the sand was replaced by fine stones.) Observations of bottom preference for nest building were made.

An experimental trough was also placed in the stream with one half of it covered with a black plastic sheet while the other end was kept in the sunlight on a riffle area with a current flow similar to that of the actual spawning riffles.

(b) Spawning Requirements of Lampetra

Maturity of Sex Products

The prime requirement for spawning activity is the presence of mature reproductive products. Evidence for this conclusion is shown in the following two examples.

On April 29, 1963, an immature Lampetra from the Salmon River was introduced into a 16-20°C tank containing gravel. The animal immediately burrowed into the gravel and remained concealed until it reached maturity on June 2. During this time other mature L. planeri used the tank for spawning but the immature specimen remained beneath the gravel. The specimen appeared to be a male when first introduced into the tank, but after three weeks its abdomen began to swell and distend, and the pseudoanal fin began to enlarge. On June 2, the animal left the gravel and began to swim actively around the tank and at the surface of the water. Mature eggs could be seen clearly through the transparent and distended abdomen.

Two male Lampetra were collected from the fish fence at Sweltzer Creek on April 4, 1963, and placed in an 8-10°C tank for observation. They remained burrowed under the rocks for the first three weeks but in the fourth week they made exploratory swimming excursions around the tank and began to lift rocks and dig periodically. They became more active and spawned with females that were introduced into the tank. One died on June 4, and the other was killed on May 27 as the viable sperm was used to fertilize eggs.

Spawning temperature and gravel were present in each of the above instances but the animals did not mature and move from the gravel until their sex products and secondary sex characteristics were mature. In the Salmon River, the differences in maturity date between individuals accounts for the long spawning period- from April to July.

Temperature Effects

Brook lamprey of the Salmon River were observed spawning and laying eggs under laboratory and field conditions within the temperature range of 8-20°C . Hardisty (1961) states that temperatures of 10-11°C are critical to appearance of spawning activity in Lampetra planeri in the river Yeo. He recorded isolated animals on the spawning site at temperatures below 10°C. A marked rise in numbers of animals occurred as the temperature rose above 10-11°C and showed a high degree of correlation with temperature. This behaviour was verified in laboratory observations on Salmon River lampreys in a cold tank (8°C) where most animals hid beneath the gravel, but when the temperature rose above 10°C. all the animals

left the gravel.

In 1961 the first adults were seen in May. However, the temperature was above 10°C . for some time before this (indicated by Fig.6) therefore first spawning could have occurred during the last two weeks in April.

In 1962 the first sign of spawning was observed on April 20, at a temperature of 9°C . High intensity spawning in a number of communal nests was observed. The temperature and flow data which indicates flooding clearly shows that spawning probably started near the 10th of April. (Fig.7). This was verified by examination of some of the females that were in a spawned out condition. By analysing flow and temperature data for 1961 and 1962 it is possible to conclude that spawning could start in the Salmon River as early as the 10th of April and extend until the first week in July.

In 1963 the river was checked in late March and on April 7, but the temperature was low and no adults were obtained with seining or on the gravel areas. Spawners were first seen on April 20 when the temperature was 11°C at station 1, and 11.5°C at stations 4 and 6. When these spawners were dissected it was found that some were spawned out, especially the upstream individuals. In general it appears that in the Salmon River spawning commenced in mid-April.

Schultz (1930) found L. planeri spawning in Washington State streams during a similar time to that reported for British Columbia. Carl (1953) reported Lampetra spawning in Holmes Creek in May. The Sea Lamprey prefers a much higher

temperature (18-21°C.) for initiation of spawning (Applegate 1950, Scott 1957, and Wigley 1959). The above workers found that if the temperature dropped below 18°C. the Sea Lamprey stopped spawning. This does not occur in Lampetra of the Salmon River for as temperature dropped the spawning did not stop, but spawning behaviour is definitely affected by temperature as will be discussed in detail later.

Flooding

Flooding limits spawning after the temperature rises above 10°C. because the increased current prevents the adults from occupying a position on the gravel. Seining over the gravel areas during flooding did not produce any adults although adults were common on the same stretch of gravel two days before flooding occurred. Temperature and flooding conditions in 1962 indicate that spawners should appear on the gravel during the second week in April.

Current Preference

A large trough filled with gravel was placed in a riffle area of the Salmon River where the current was 3 feet per second (Fig. 27). A board over the end screen controlled the current in the tank. A current of 1 ft. sec. was maintained and 8 adults were introduced into the rear of the trough. The position of the adults was observed after one hour. Then the current was increased to 2 ft. per sec. and the position of the adults recorded again. The experiment was repeated with eight new adults introduced into the front of the trough and the same procedure was followed as in the previous run. The

experiments were performed on April 27, 1962, with a water temperature of 11°C .

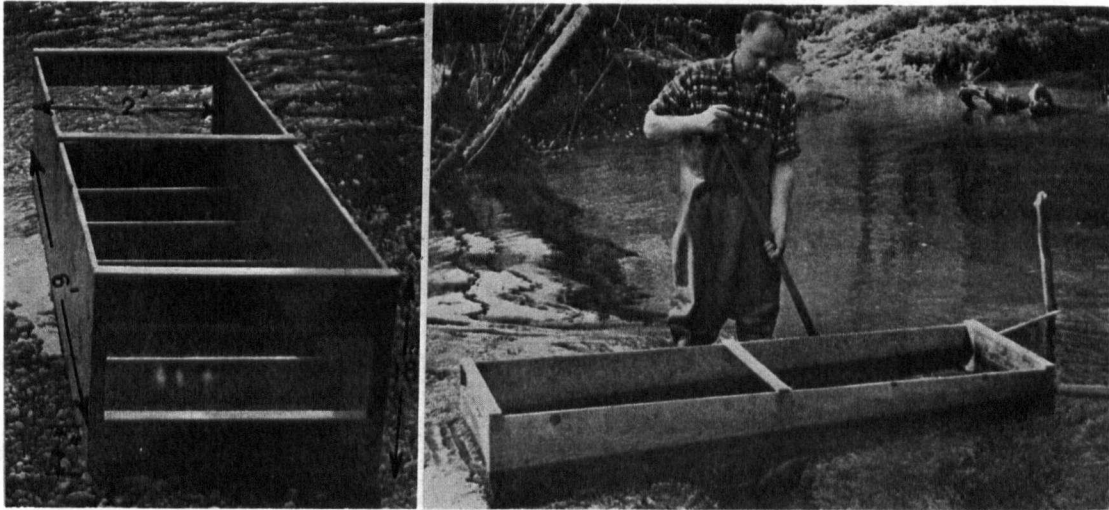


Fig. 27 Experimental trough to test response of adults to current

A current is a requirement for spawning in the stream habitat. In the Salmon River spawning always occurred in gravel over which a current flowed. Lampetra constructs its nest above riffle areas in current from 1 to 1.6 ft. per sec. velocity at the surface. Current seems to be related to depth of water over the nest since 8-15 inches is the range of water depth observed (See Table 4). In natural conditions current and correct depth of water are more essential than light to spawning requirements. However, the presence or absence of a current did not affect spawning behaviour or fertilization of eggs in aerated aquarium water. Spawned eggs in the gravel of the aquarium hatched without extra care or consideration in 1962 and 1963. Kennedy (1957) and Scott (1956-57) have also found that Sea Lamprey can spawn in perfectly still water

if the correct temperature and substratum are present. They were able to obtain fertile eggs from such spawnings. Current seems of little importance in aquaria, but when a large spawning tank was constructed in 1963 with a small circulating current the nests were always constructed in gravel under the greatest current flow. Therefore, although fertile eggs have been spawned in still aquarium water, indications are that lamprey seek gravel over which a current flows. Current seems to function in mixing the egg and sperm during the release of sex products, and in insuring a ready supply of oxygen for the eggs in the gravel.

Shade Preference

The trough (Fig. 28-1) was placed in a riffle area of the Salmon River on May 10, 1962, and the current was adjusted to 1.5 ft. per sec.. A large black plastic sheet was placed over half the trough and 9 adult lamprey were introduced

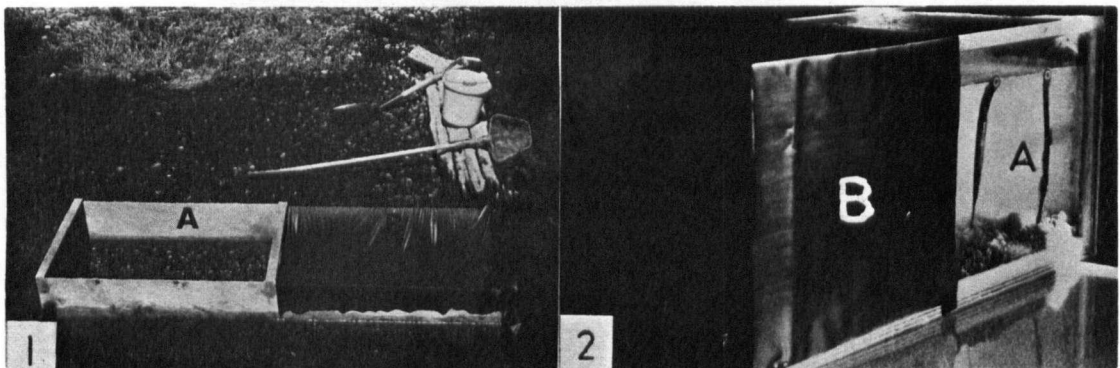


Fig. 28 Experimental trough in the stream (1) and laboratory tank (2) to test the preference of spawning adults for light. A- sunlit section; B- shaded section.

into the downstream end (light) of the tank. The position of the adults was recorded after 2 hours (1200-1400 hr.) of exposure to the apparatus. The plastic sheet was then moved to the opposite end of the trough and the position of the lampreys was recorded two hours later (1400-1600 hr.). One week later six adults were introduced to the upstream half of the trough (dark) and the above procedure was repeated.

A 10 gallon wooden aquarium (glass 2 sides, Fig.28-2) was set up in a basement window and half of the aquarium was covered with black plastic. Twelve spawning Lampetra were introduced to the tank and observations were made at 0700 and 1700 hours daily.

Light

Sunlight seems to have some influence on the choice of nest site. Spawning lampreys generally seek shaded areas in the gravel for nest construction. However, many nest occupied by spawning adults were observed in open riffles during bright sunlight (Fig. 29). Therefore other factors such as current, bottom composition, and water depth seem more important factors than sunlight.

Laboratory experiments showed significantly that lampreys preferred the shaded area of the tank in daylight. Less than one third of the 14 experimental animals were seen on the sunny side of the aquarium during the week study period, and on 10 occasions no animals were observed on the sunny side of the aquarium.

Hagelin and Steffner (1958) state that bottom



Fig. 29 A pair of actively spawning L. planeri in the Salmon River in bright sunlight. The pair is occupying a crude nest constructed between the larger rocks.



Fig. 30 Lampetra spawning in the shade of a log in the Salmon River.

conditions are more important than light. They performed similar observations to those above and found that L. fluviatilis preferred the shade as a site for nest construction. In the riffle nests of the Salmon River Lampetra are found in both shaded and sunlit areas.

These observations led to further stream observations and a trough experiment in the stream where all spawning factors were present. Ten spawning Lampetra preferred the shaded part of the trough when they were allowed to distribute themselves for a two hour period. The gravel, current, and depth of water were identical to that of natural riffle areas. A black plastic cover was then moved to the opposite end of the trough. All but one pair of the animals moved from the sunlit gravel to the shaded area. This pair which had started to construct a nest remained on the gravel in the open sunlight and continued with the nest construction. This suggests that nests that are occupied in the sun are probably constructed in the night but the animals will remain in the nest or hiding beneath the rocks in the nest in bright sunlight. Near station 1 where the gravel was small and produced little shade of its own, nests were built usually in the shade. Upstream where the large gravel produced more shade of its own, nests were common in open sunlight. On one occasion six communally spawning adults were seen taking refuge in the shade of a log (Fig 30). Hardisty (1944) found that Lampetra showed a preference for spawning in the shade and usually built nests under a bridge or in a position partly shaded by trees or buildings.

In bright sunlit nests, the animals are easily frightened and will swim extremely swiftly at the surface of the water to hide downstream in the riffles or upstream in the pool area. Males show a greater awareness of their surroundings than do females. The body of a female can be touched in the nest without causing her to leave the nest, but males respond immediately to the same action. The animals in the shade are not as easily frightened from the nest.

Bottom Preference

One half of the compartments of the trough (Fig. 27) were filled with sand and the other compartments were filled with gravel. Six adults were introduced to the sand end of the tank and the animals were allowed to distribute themselves for a one hour period. The position of the bottom type was reversed and the same six adults were introduced to the gravel end of the trough, and their position recorded after the one hour period. The temperature, when these experiments were performed, of the Salmon River was 12°C on April 25, 1962.

Half the bottom of a 5 gallon aquarium was filled to a depth of 3 inches with sand and the remainder of the tank was filled with spawning gravel from the Salmon River. The tanks were placed in an east-facing basement window and two different groups of 6 adults used the tank for spawning at temperatures of 16 to 18°C. Spawning activity in the two parts of the tank was recorded. Gravel seems to be an important ingredient of the habitat for spawning lampreys. Lamprey pairs never spawned in the sand area of an experimental tank. On

occasion single individuals would hang onto the glass and dig violently in the sand. This is probably a form of low intensity spawning behaviour similar to the spawning act. However, two females released eggs when kept in a sand-bottomed aquarium. Hagelin (1959) found that L. fluviatilis in aquarium conditions selected a mixture of sand and gravel over other bottom types. Scott (1956-57) reported that Sea Lamprey invariably choose a mixture of coarse sand, gravel, and small rocks over other bottom types for a nest site. Dendy and Scott (1953) found that no spawning occurred in a bare aquarium but as soon as coarse sand, gravel, and stones were placed in the aquarium immediate stone moving and spawning followed. Hagelin confirmed the same reaction in L. fluviatilis. Applegate (1950) showed a correlation between amount of spawning gravel present in the stream and the number of spawning lamprey. L. planeri in British Columbia displayed no signs of spawning when kept in a bare aquarium.

Entosphenus

Entosphenus has similar spawning requirements to Lampetra. They appear to be less sensitive to sunlight but nest construction is limited to a few sites in the stream. During the 1962 and 1963 spawning, the same nest locations were used.

(c) Sexual Dimorphism at Maturity

Lampetra

Recently transformed lampreys can not be separated sexually on the basis of exterior morphology. The two dorsal

fins are separated in the transforming adult and grow continually together as maturity approaches (Vladykov 1955). The intestine reaches its maximum state of degeneration at the onset of spawning. No food is consumed for at least one year or possibly two years prior to spawning (Leach 1940). After spawning commences the dorsal fins, area surrounding the urogenital opening, and the buccal disc of both sexes may become infiltrated with blood. These are some of the general identifying characteristics of arriving at the adult stage.

Zanandrea (1961) recorded neoteny in Italian Brook Lamprey ammocoetes. This condition was similar to sexual dimorphism with the growth of a pseudofin, transparency of the body wall but the endostyle and naso-pharynx remained in the larval form. This condition was never recorded in the Salmon River population.

No exact time of sexual maturity occurred in the Salmon River population, but the appearance of sexual dimorphism and maturity occurred throughout the spawning season. Hagelin (1959) found the period between sexual maturity and the appearance of sexual dimorphism was two weeks. He observed decreases in size during and after transformation, as well as a continual loss of weight as spawning progressed.

Four adults obtained with an electric shocker in May of 1962 revealed them to be in the early adult stage. Their oral hoods were reduced in size and no pseudoanal fin or body swelling was observed on the female. After a period of from one to two weeks in the aquarium these animals

matured, developed secondary sex characteristics and began to show spawning behaviour. This was also observed on one female collected in early May in 1963 yet it remained burrowed in a warm tank (16-20°C) until the end of May when the eggs and other sex characteristics were mature. All recent research indicates that all spawning parasitic and non-parasitic lampreys develop secondary sex characteristics at sexual maturity. The old idea that some specimens show no sex differentiation is no longer correct when complete information of life history is available (Zanandrea 1961).

There appears to be no difference in colouration between the sexes. Two colour phases in the Salmon River population, one yellowish golden-brown, the other a grey-black phase on the dorsal surface, are not characteristic of either sex. All spawning adults can be distinguished from transforming larvae by the presence of yellow or brown pigment in the fins (Zanandrea 1961).

Male Characteristics

Twenty male L. planeri (mean length 110.2 mm.) and twenty females (mean length 110.0 mm.) were selected at random from the Salmon River adult collections for measurements and comparison of sexual characteristics. The following external characteristics are those that appear on a sexually mature male (Figures 31 and 32).

1. A slender urogenital papilla is present in all males with a range in size from 5.6 to 0.15 mm. However different degrees of protrusion make exact measurement difficult. Hagelin and

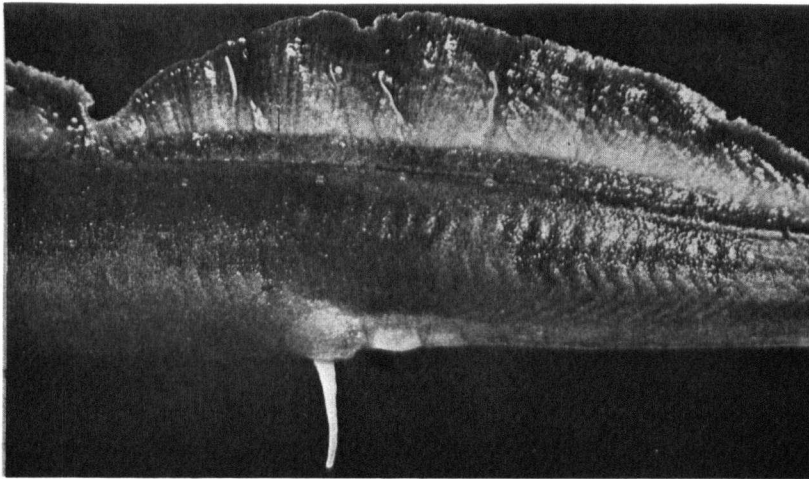


Fig. 31 Lateral view of the urogenital papilla of a male *L. planeri* and the surrounding structures (Salmon River)

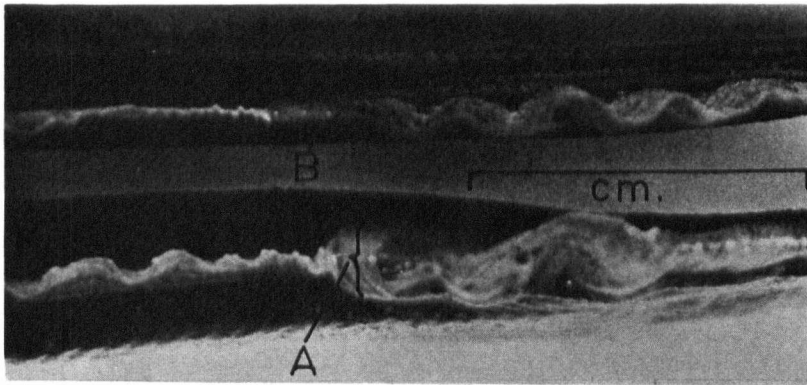


Fig. 32 Dorsal view of the second dorsal fin of *L. Planeri* comparing the swelling present in the female (A) to no swelling in the male (B).

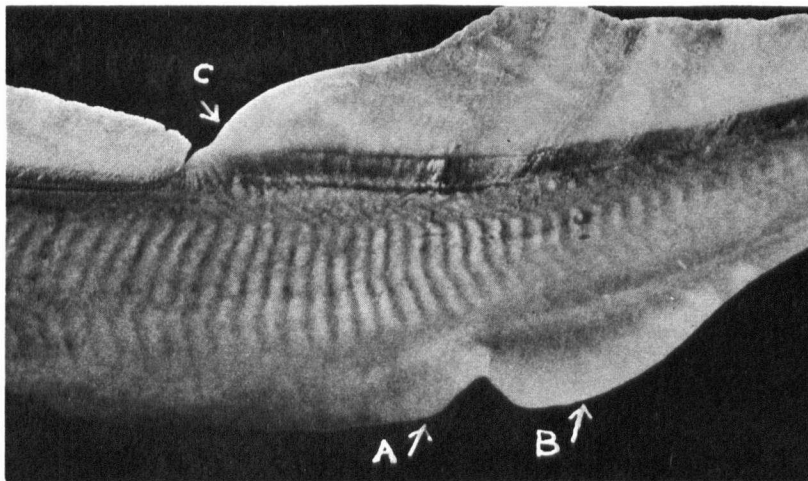


Fig. 33 Lateral view of the swellings present in the female (A, B, C) Salmon River specimen

Steffner (1958) reported the maximum length in the River Lamprey as 6 mm (Fig. 31).

2. The two dorsal fins of the male are slightly higher than females (1st. dorsal 3.8: 3.06, 2nd. dorsal 6.3: 6.03, males to females). The base of the second dorsal fin is not swollen as is the case of the female (Fig. 32).

3. No significant difference was observed between eye diameter, yet Vladykov found a larger eye diameter in European Lampetra males.

4. The oral hood of males is larger than that of females (\bar{x} 5.73:5.13).

5. Slight or little hypertrophy was noted around the vent as described by Hagelin and Steffner (1958).

6. The tail of the male bends downwards while that of the female bends upwards (Fig. 34).

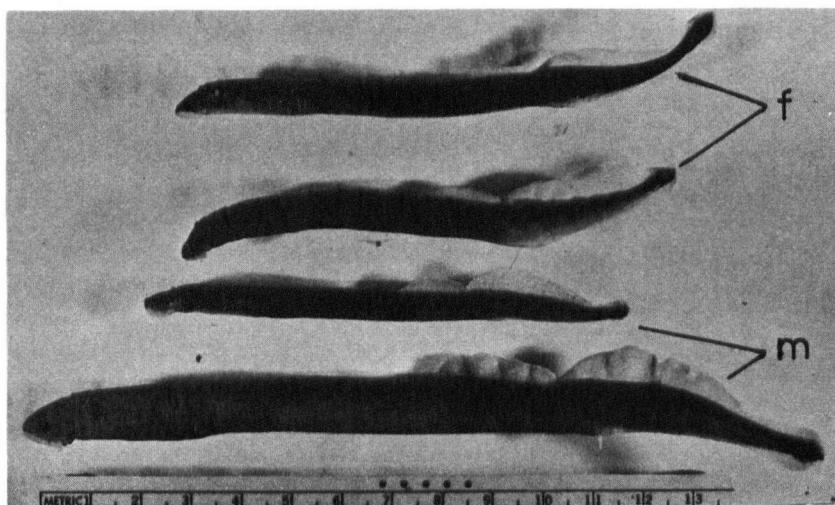


Fig. 34 Displays the upward bend of the tail of females and the downward bend of the tail of males of L. planeri from the Salmon River. (m = males, f = females)

7. The trunk of the males are shorter than the females, while the tail of the male is longer than that of the female.

Female Characteristics

The following characteristics appear on a sexually mature female:

1. A pseudoanal fin appears posterior to the vent (Fig. 33) in the mature female. This fin may become filled with blood due to rupture of capillaries during the digging of the nest.
2. The second dorsal fin is markedly swollen at the anterior edge (Fig. 32). The semitranslucent oedema often becomes filled with blood as spawning progresses. The swollen fin is alleged to serve as a stop for the male's tail as it coils around the lower body of the female and thus directs the sperms on the eggs during the spawning act (Hagelin and Steffner 1958).
3. The anterior edge of the vent is usually swollen in a similar manner to the pseudoanal fin.
4. The sucking disc is slightly smaller in the female.
5. The trunk of the female is longer than that of the male, while the tail is usually shorter.
6. The abdominal body wall becomes transparent and distended so that individual eggs can be seen within. However, spawned out or nearly spawned out females may have very slender bodies.
7. The tail of the female is usually turned upwards and is particularly noticeable in the well preserved specimens and live animals.
8. The urogenital papilla of the female is reduced in size

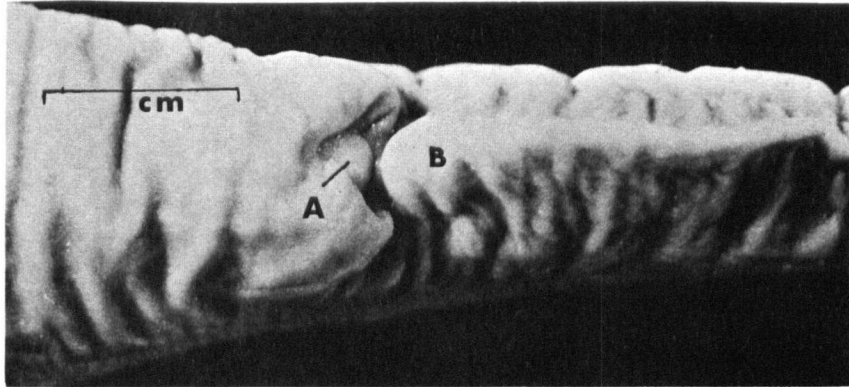


Fig. 35 Ventral view of the urogenital opening of E. tridentatus showing the papilla (A) and the pseudoanal fin (B). Salmon River specimen.

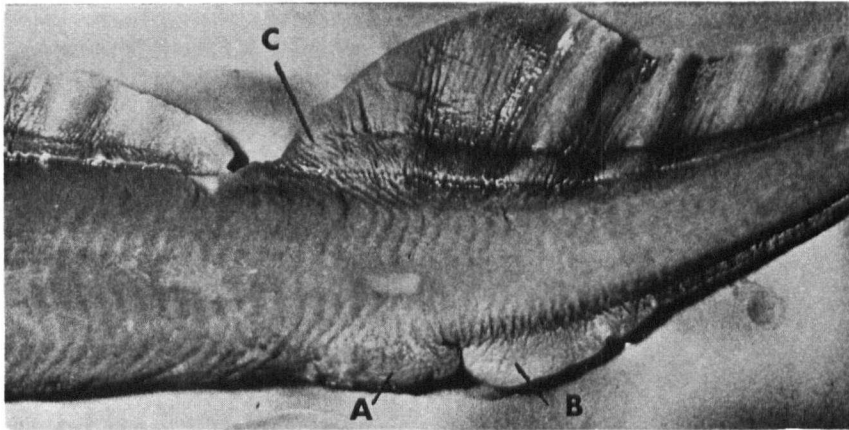


Fig. 36 Lateral view of the swelling of the female E. tridentatus at the positions indicated by the arrows.

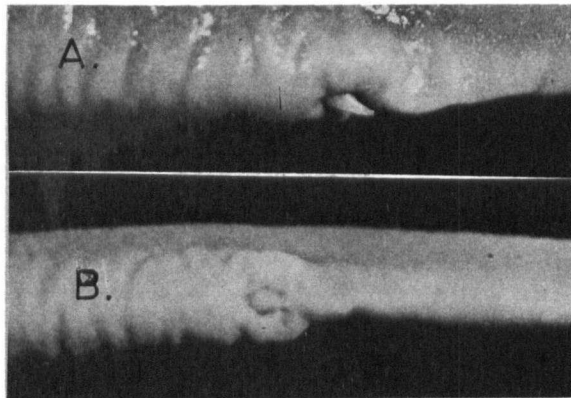


Fig. 37 Lateral view (A) and ventral view (B) of the urogenital papilla of the male E. tridentatus, showing the absence of the ventral swelling.

(less than 2 mm.) and is usually enclosed by a fold of swollen skin.

Entosphenus

Entosphenus possess the same major sexual dimorphic characteristics found in Lampetra (Figures 35, 36, and 37). The males are usually a red brown colour while the females are a darker brown or grey colour. The female body wall never becomes transparent as it does in Lampetra. The urogenital papilla of the male is much shorter in length compared to Lampetra. The body is usually very much distended in the unspawned female (Fig. 38A and 38C).

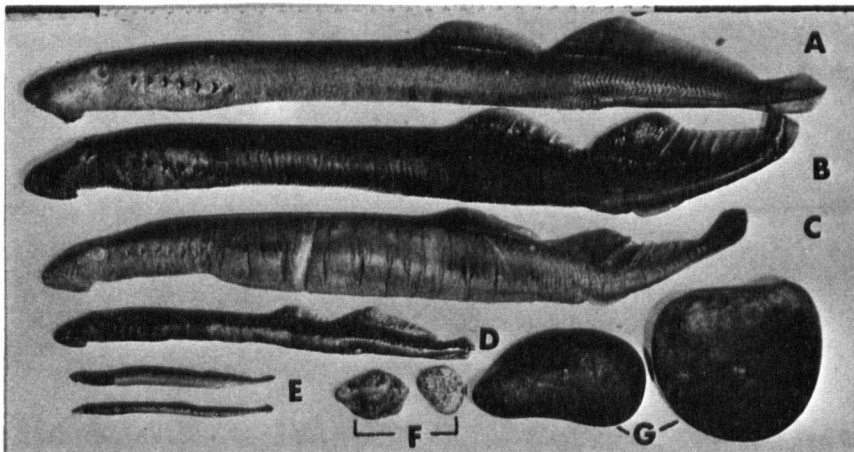


Fig. 38 Salmon River spawning adults.
Lampetra (E) and Entosphenus (A, B, & D) were taken from a communal nest.
 The distended female (C) contains over 106,000 eggs (Hooknose Creek)
 The rocks (F) from a Lampetra nest.
 The rocks (G) from an Entosphenus nest.

(d) Prespawning ActivityLampetra

Few specimens were collected and observed during this stage because lampreys burrow into the gravel and thus become difficult to collect by conventional seining and digging methods. Several attempts to collect adults during the winter months when Lampetra should be in the prespawning condition produced no specimens. A portable electric shocker was used in May, 1962 to collect four adults that were burrowed into the gravel above a riffle area of the Salmon River. These specimens were not captured when the area was dug over and swept with a seine the day previous. Two males were collected from the fish fence at Sweltzer Creek in 1963 in early April. One female was collected from the Salmon River in early May, 1963, by digging and seining at night. The electric shocker method seemed to be most productive in obtaining specimens of adults in the prespawning condition during the winter and early spring. The animals appear to burrow into gravel areas at the lower end of large pools during the prespawning period. They seem to be inactive and are not seen unless disturbed. Lampreys appear to spend this period in dormancy while maturity develops.

Collected specimens observed in an aquarium burrowed beneath the gravel and were not seen until they emerged in spawning condition with sexual dimorphic characteristics fully developed. In the prespawning stage the males cannot be distinguished from the females.

A slight migration in the Salmon River is suspected prior to spawning, from the muddy lower reaches to above station 1. No spawning gravel is available below station 1 and the flooding conditions of the stream during the winter carries ammocoetes to the lower silted regions of the stream. On April 20, 1962, and 1963, a migration of spawning adults was observed above station 1. One mile above the station and at station 2 no adults were seen but spawning adults and adults moving upstream were captured on the gravel at station 1 (Fig. 3). P. Wickett (personal communication) collected lampreys at the fish fence on Nile Creek from 1948 to 1954 and recorded movement of lampreys down the creek from April to July with the peak movement occurring in May and June. These figures reveal some movement during the prespawning period but the greatest movement within the stream occurs with the onset of spawning.

Leach (1940) observed laboratory-held I. fossor to be semi-sedentary until January when some specimens did not bury themselves while others were seldom out of the sand until April. Leach measured seven individuals kept in a cool cellar during the winter and found that they reduced their length by 10 percent during the prespawning period. These animals seemed to lack the normal spawning stimulus to spawn naturally, but the sex products proved viable when fertilized artificially.

Schultz (1930) noticed an apparent tendency for the males to appear on the spawning grounds before the arrival of

females for Lampetra planeri. However no evidence of this was found on the Salmon River. Applegate (1950), Gage (1928), and Wigley (1959) maintained that males arrived on the spawning area before the females, chose the location, and started to dig the nest. The females were observed to join the males later and assist with construction. The above authors suggest that there may be a form of territoriality set up by the males.

Thus, the prespawning period is generally a time of little activity that stretches from the end of transformation to the beginning of the first signs of spawning. This period is from one month to two weeks in duration as the exact time of completion of transformation and the beginning of prespawning is extremely difficult to determine. Prespawning extends from March to June in the Salmon River and depends on the maturity of the individual Lampetra.

Entosphenus

Less is known about the winter life of Entosphenus than Lampetra as few have been collected or observed during this time. One specimen was dug from between boulders in December on the Nicola River; another was removed from the gravel at night on March 15 from the Alouette River. Three adults nearing spawning condition (sperm active) were captured at the fish fence at Sweltzer Creek on the first of April. Thus a sedentary burrowed existence is indicated during the greater part of the prespawning and winter period with migration and movement within the stream starting in April.

From aquarium observations of behaviour during April

prior to spawning, the males are more active at lower temperatures than Lampetra. Entosphenus spends part of the prespawning period resting attached to the bottom rocks or the aquarium glass while Lampetra spends more time burrowed in the gravel.

(e) First Sign of Spawning

The animals leave the gravel and move to the riffle areas of the stream. They were observed lifting rocks and moving about on the nests. They are usually seen hiding in the shade or under rocks during this early period, while later when spawning is more intense they are seen on the gravel in bright sunlight. It was difficult to determine the first sign of spawning as the stream was not visited daily. However a form of low intensity nest construction or "play with stones" was observed. Both males and females lifted and dropped stones haphazardly without construction of a nest in any one locality. There seemed to be considerable movement within the gravel area before nest construction was started.

When adults in the spawning or prespawning condition are introduced to an aquarium they burrow into the gravel for a number of hours. The first spawning signs involve the adult leaving the gravel and resting attached to rocks. Searching the aquarium and frantic swimming around the surface of the aquarium usually follow and rock lifting and digging by individuals occurs later. Individuals may leave the gravel for a short time to dig and lift rocks, and swim at the surface but spend the remainder of the day resting under the rocks. There is a greater frequency of activity on the gravel during

the darkness hours before actual spawning starts.

Hagelin (1959) observed a similar restless behaviour in the River Lamprey. The male often plays with stones by lifting and dropping them immediately or by a combination of lifting and swimming on the side of the body with the body arched like a bow; it glides along the bottom.

These low intensity activities of "play with stones" and digging probably prepare the adult for the more vigorous behaviour of actual spawning that is to follow. The first signs of spawning start when the temperature rises to 11°C . (Hardisty 1944 and Schultz 1930) while the temperature for initiation of spawning is $12-13^{\circ}\text{C}$. as reported by Wigley and Hagelin (1959). In Salmon River lampreys a temperature of less than 10°C . will initiate females to start spawning while a temperature above 10°C . has a highly stimulating effect on males.

(f) Nest Building

Normal nest building by Lampetra in the Salmon River commenced after the temperature rose above 10°C . but spawning and nest building was observed at a temperature of 9°C . (low temperature for spawning) on April 24, 1962. However, the temperature had previously risen above the 10 to 11°C . apparently necessary to initiate the action (Hardisty 1954).

The male (above 10°C .) was the instigator of nest construction and contributed at least two-thirds of the effort of construction. The female helped the male complete the nest after it had been started. She contributed much less to the endeavour especially after spawning had started, for much of

her time was spent with her body draped in the nest with oral hood attached to a rock at the edge of the nest.

Nest construction involved three definite actions on the part of either adult:

1. Rock lifting was similar to the rock play already mentioned. Small rocks less than $3/4$ inch in diameter were removed to the side of the nest. Most often the rocks were removed to the downstream edge of the impression, but occasionally rocks were carried upstream or to the sides of the nest, a distance of usually not more than six inches. Hardisty also observed this (1944). Rocks weighing up to 30 grams were rolled or pried from the nest, but rocks less than 15 grams were removed easily by a lamprey swimming with it. A lamprey needs three swimming movements per second in order to lift a 2 to 4 cm. stone (Hagelin 1959).

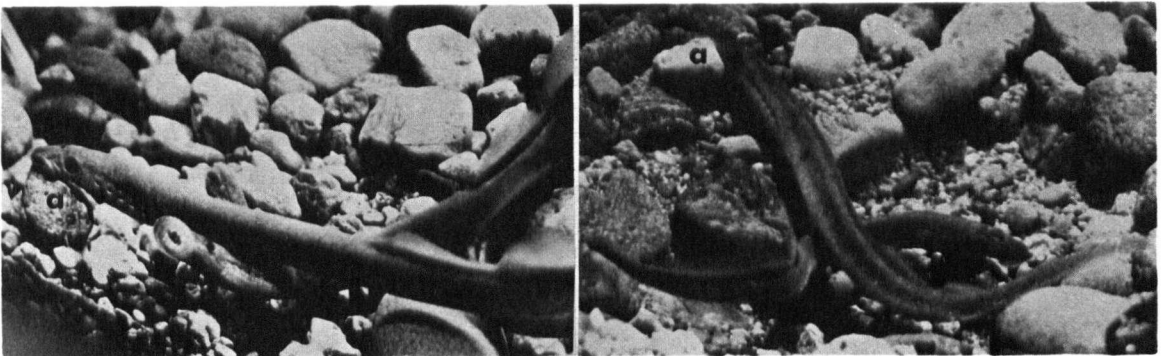


Fig. 39 Lampetra removing rocks from a nest in an aquarium.
(a is removed rock)

In an aquarium the nest was round but in the stream it was usually wider than it was long (See Table 4 for sizes of nests). In an aquarium a male usually built a nest where he started construction, but in the stream he would often start a nest, partially complete it, and then wander away to a nest occupied by a number of other lampreys. The first nest was completed later by another animal or group of animals.

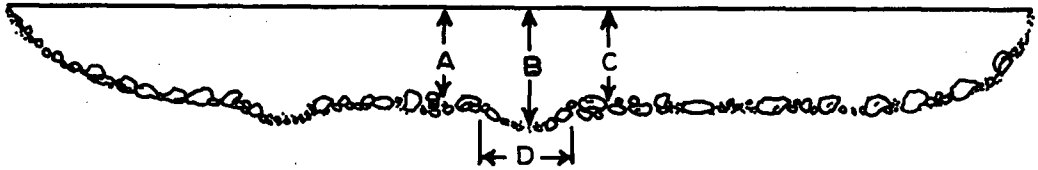
(g) Combination Rock Lifting and Digging

This act was performed by lampreys in removing large rocks from the nest. The buccal funnel was attached to the rock, the body was arched in a prying motion, and the tail performed vigorous swimming movements. The action was so vigorous that sand and small stones were stirred up from the bottom of the nest. Hagelin analysed this and found that the swimming movements were at a frequency of five or six per second. If the rock was very large it was rolled or carried along the bottom and out of the nest. The lamprey occasionally turned on its back or side to pry a large stone loose; its body would rest on the bottom. The muscular movements of the head dragged or rolled the rock a short distance. On a number of occasions two lampreys were seen attached to one rock and removed it from the nest but this was apparently a chance occurrence rather than co-operation.

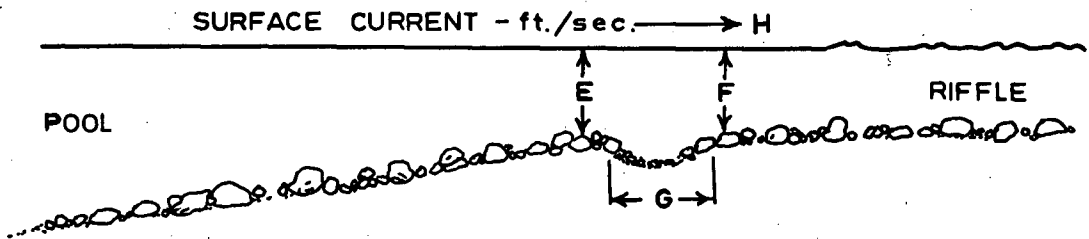
(h) The Digging Action

This action followed when the nest reached a depth of one inch or when some of the surface stones had been removed. The buccal disc was attached to a larger stone at the edge of

Table 4. Analysis of the depth of water and current velocity above nests occupied by spawning adults on the Salmon River.



Cross-section through a Lampetra nest. Depths tabled below.



Longitudinal section through a Lampetra nest. Depths and current tabled below.

		Water Depth in inches. Current in ft. per sec.							
		A	B	C	D	E	F	G	H
<u>Lampetra</u>									
April	20/62	15	15	12	15	13	13	15	1.5
"	25/62	12	13	12	4	12	12	3	1.6
May	20/62	12	13	11	5	11	11	5	1.5
"	27/62	6	10	5	12	6	6	7	1.5
June	10/62	9	12	10	6	8	8	7	1.6
"	"	9	10	9	12	9	9	9	1.6
"	"	9	11	9	10	9	9	10	1.5
"	"	9	10	9	7	9	8	6	1.2
June	14/62	7	10	8	5	7	8	4	1.2
"	"	13	15	12	13	13	13	10	1.0
June	22/62	10	14	11	18	11	9	24	1.0
"	"	7	8	7	9	7	7	5	1.5
Mean		9.8	11.7	9.5	9.7	9.6	9.4	8.8	1.4
<u>Entosphenus</u>									
April	20/62	16	17	11	21	16	6	22	1.2-1.6
April	28/62 (Abandoned)	13	18	15	21	12	15	23	<1.6

the nest and while the animal was on its side the tail vibrated rapidly at a frequency greater than seven movements per second. The sand and small rocks were lifted from the bottom of the nest and flipped out of and to the sides of the nest, thus making the nest deeper (Fig. 40). This behaviour was undertaken by both male and female but in the stream at higher temperatures it was more frequently peculiar to the male. Rock lifting can follow digging but usually digging immediately preceded the spawning act when the nest is completed or after spawning has started.

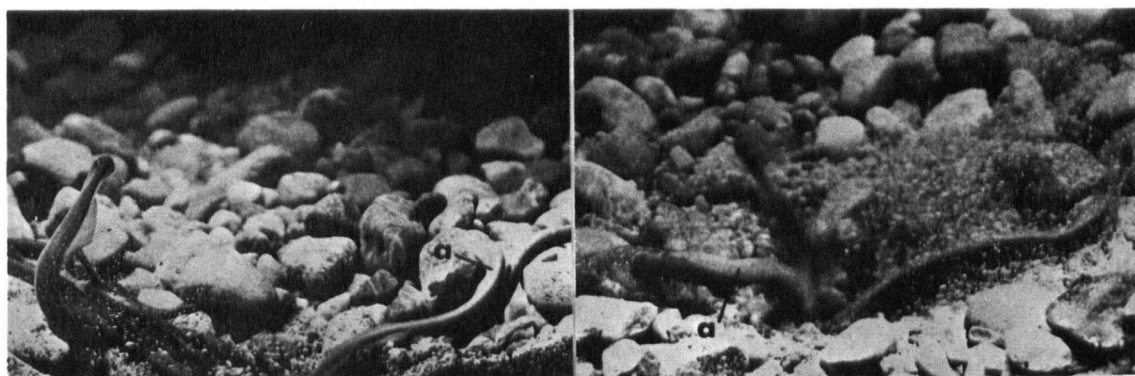


Fig. 40 Lampetra in an aquarium nest displaying digging action. (a is a digging adult)

Digging serves to loosen the bottom and line the bottom of the nest with sand which is important for anchoring the eggs in the nest. From observations it is apparent that the vigorous digging action also serves to move the sex products to the urogenital opening as only a few eggs are laid and released from the main egg mass at a time, starting from the posterior end and proceeding forward.

Entosphenus

The behaviour of Entosphenus differs from that of Lampetra only in the intensity of the actions, the size of the nest, and its location in the stream. Table 4 shows the larger dimensions of the nest and Fig. 41 shows a cross section of an Entosphenus nest. A comparison between Salmon River lampreys taken from the nest and the nest stones is shown in Fig. 38. A spawning pair was observed for a five hour period in the Salmon River on April 20, 1962. They deposited eggs regularly every two to five minutes throughout the observation period. Nest construction and digging was carried on between spawning acts with the males contributing the majority of the effort. However, the female contributed some rock lifting and digging between every spawning. Rocks weighing 660 grams were

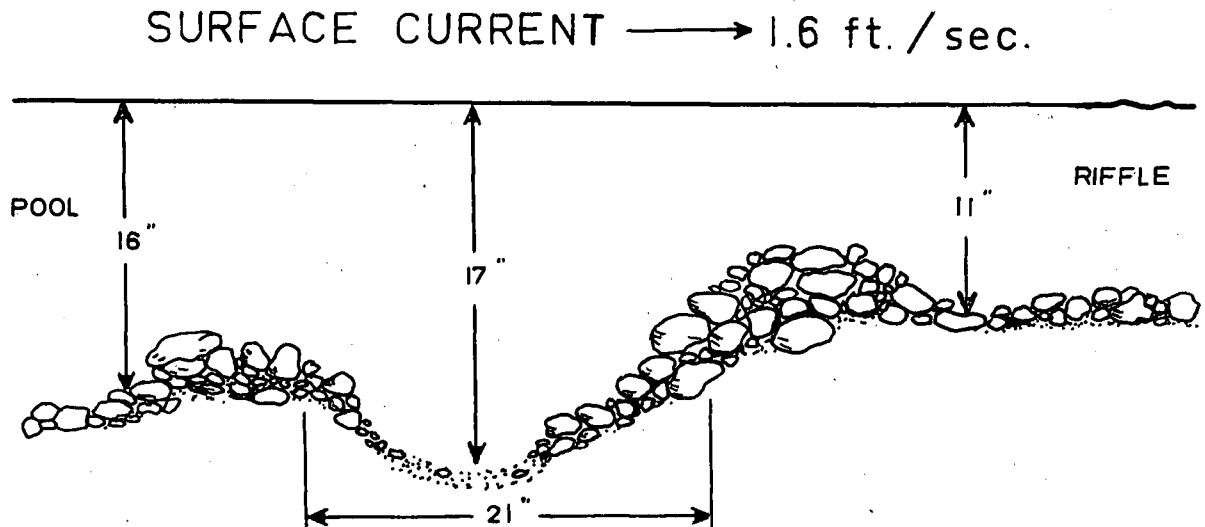


Fig. 41 Longitudinal section through a nest constructed by a pair of large Entosphenus (> 400 mm.) on the Salmon River.

observed being rolled from the nest. Both adults were observed lifting together a large rock from the nest, but as with Lampetra this is apparently a chance matter of both lampreys attaching to the same rock at one time.

(i) Courting Behaviour

This behaviour is usually confined to the nest site and is most often exhibited by the male, but females do display a similar behaviour. The male and the female are usually seen jointly building the nest. The female, just prior to release of eggs, rests in the nest with her buccal disc attached to rocks at the upper edge of the nest while the male continues to dig and lift rocks from the nest. Her body lies curved in the bottom of the nest and undulates slowly back and forth. The male passes over and under her body as he digs. She may dig, rest, and undulate again. Usually just after digging, followed by a short rest, the male moves to the bottom of the nest and touches the female's body with his buccal disc and moves, with a "gliding-feeling" motion, up her body to the top of her head.

Hagelin (1959) describes a courting or prespawning behaviour in L. fluviatilis in which the female swims in circles over the nest-constructing male. As she passes over the nest she sinks down so that part of her abdomen passes over the male's head at five or six second intervals at each excursion. These courting circles were not observed in L. planeri, nor was there any violent shaking by the female in the nest; Hagelin may have interpreted the digging behaviour as

shaking. However, a shaking behaviour was observed when the female was attached to the aquarium glass.

The Salmon River female lampreys were also observed courting with glide-feeling advances to a male not on a nest. This was observed toward other females in the nest at various times, as is shown in Fig. 42A. This shows three females occupying one nest but no male is present on the day which followed high communal spawning. The two outside females in the figure are undulating and the centre female has completed a courting glide up the female attached to the glass. This method of attachment of a female to another lamprey was not as forceful and only on rare occasions was there arching of the forebody or vigorous vibrations. However, when two females are allowed to spawn without the presence of a male they usually both attach the buccal disc to the glass or a rock and vibrate vigorously with their bodies touching. Eggs were observed being released with each vibration until all eggs were spawned in a week's time.

A low intensity of courting involves the rubbing of the body of one sex against, under, or over the body of another. This apparently tends to stimulate the less receptive partner into activity, or it may increase the general pitch of spawning activity of a communal nest. A similar behaviour was observed when one male had just dug a nest but no females were to be found on the gravel. Here the male went to the corner of the tank where the other adults were and burrowed under the rocks, twisting his body about and against the others, thus apparently exciting them into action.

Entosphenus

Observations of paired and one communal spawning of Entosphenus showed that the courting action of the male is very pronounced. The female courted or glided over the male only on one or two occasions. Usually spawning followed the first or second courting glide of a male over a female. The buccal disc in male Entosphenus seemed to be used more in grasping and courting than in Lampetra. The intensity of courting in the one instance of communal spawning was that of five adults nest building only. No spawning actually took place during the observation period.

(j) Spawning Act

A few courting movements immediately precede spawning. Here the male glides and feels up the female's body to a position above her buccal disc. He attaches his buccal disc to the top of her head (Fig. 42C) and arches his forebody. This is followed by the same behaviour from the female, plus undulation of her body. The male twists his tail around the body of the female and both lampreys vibrate vigorously. Both lampreys stop vibrating and the male relinquishes his head and tail hold on the female (Fig. 42D). The eggs and sperms are released by the animals during this short interval. The action of the vibrations may be so vigorous that the rock to which the female is attached is pulled from the edge of the nest, or the female may be dislodged from the glass in an aquarium. The tail of the female is forced into the loose sand, or against it in a vertical position, at the bottom of the nest

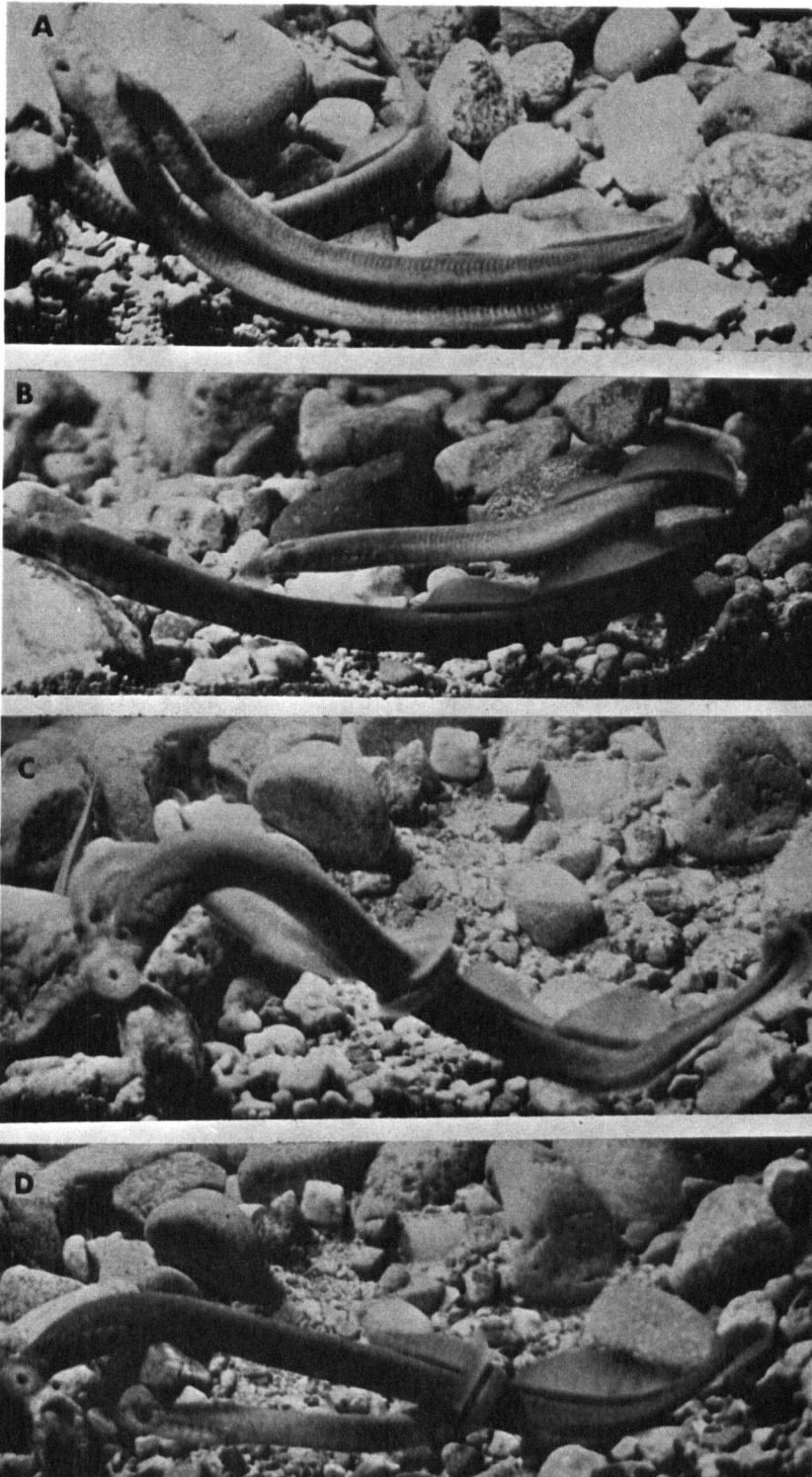


Fig. 42 Spawning sequence of L. planeri in an aquarium.
 A- females undulating in nest waiting for a male.
 B- male courting or gliding up the body of female.
 C- male grasps female by the head and twists his tail around her body, both vibrate and release sex products.
 D- male releases the head hold, both stop vibrating.

as the eggs and sperms are released (Fig. 43A, 43B, 43C). The forced vibrations cause the sand in the nest to be stirred up in a cloud. The eggs, heavier than water, are adhesive and become attached to grains of sand which sink to the bottom of the nest and are covered by the cloud of sand. When the nest was examined after a spawning act, no eggs could be seen at the surface. The papilla of both animals may be completely buried in the sand so that the eggs are actually released below the surface of the nest bottom (Fig. 43A, 43C). The tail position of the female is in a vertical plane (Fig. 45) which is quite different from the position of digging, and the sand is not sucked from the nest as in the latter case. The intensity of the vibrations is greater in the spawning act than in the digging action.

More than one pair of lampreys have been observed in the spawning act at one time. One male has been observed spawning with two females simultaneously. The male grasps one of two females that are undulating side by side; he throws his tail around one female that he has attached to and begins to vibrate, as do both females. It was not seen whether both females released eggs or not. Two males were also observed to grasp the same female at the same time. Both grasped her on the head and wrapped their tails around her body as is characteristic of the paired behaviour. Also, the males arched their bodies and vibrated violently, with release of sex products. There was no evidence of pair bond formation as males and females spawned freely with any partner of the opposite sex that

was available after the required physiological and behaviour stimuli.

Hagelin (1958) found that L. fluviatilis males always approached the females from the left side but this did not prove to be true for L. planeri or E. tridentatus in the Salmon River. These males appeared to approach the female from whichever side was convenient (Fig. 43 & 44). More approaches were from the right than from the left but this is due to the current coming from the left and the glass prevented advances from the left with ease.

After each spawning by a pair there is a short rest period during which the female usually rests in the nest while the male usually leaves the nest for a short time. He usually wanders in a circle around the nest, or he may join another nest to spawn with another female. On occasions both animals remain in the nest with the male resting beside the female or attached to her. When the male returns to the nest he starts rock lifting again and the digging motion. The nest is usually enlarged in an upstream direction; the eggs deposited are not disturbed by further spawning.

The sequence of spawning, rebuilding the nest, and courting can be predicted and analysed with precision as a series of steps. Active spawning first takes place at intervals of about five minutes. Later the activity is reduced and may occur only every few days or not at all after the major deposition of eggs. Most of the eggs from one female are laid within 12 hours. After this the spawning activity is reduced and the

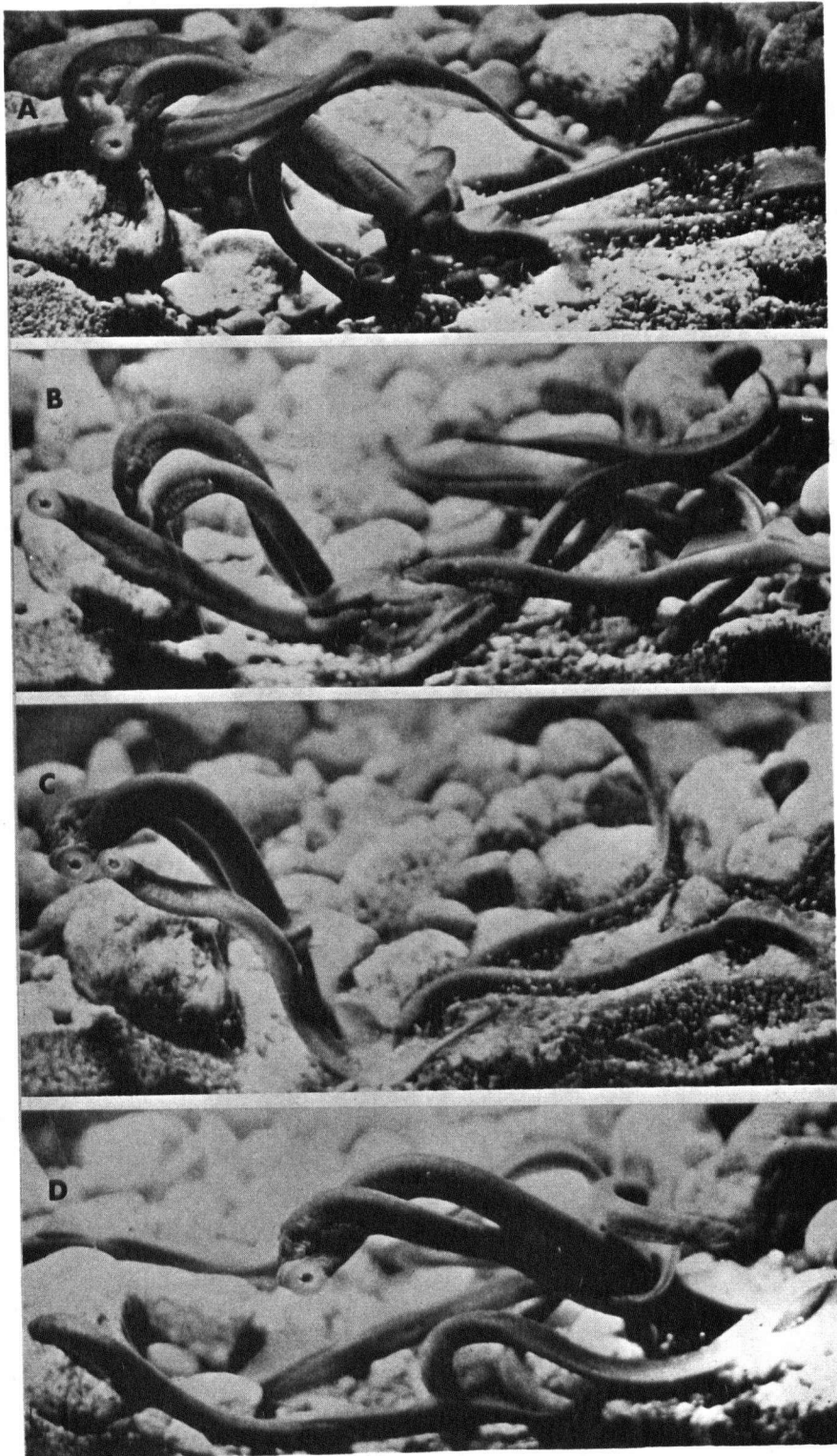


Fig. 43 Communal spawning showing the position taken by the male in grasping the head of the female. B and C- three adults spawning at once.

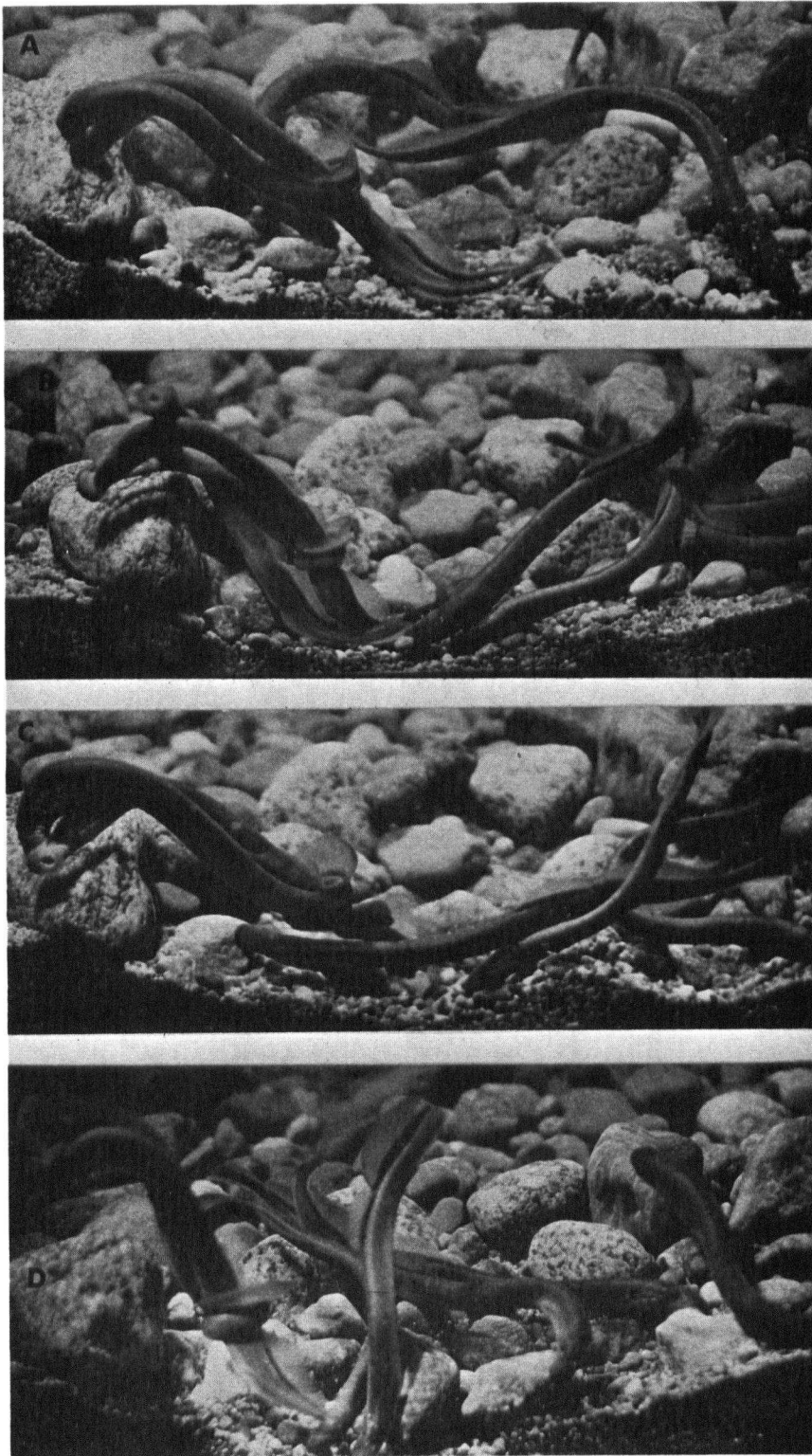


Fig. 44 Communal spawning showing the position of the tail of both sexes. A rock is being rolled from the nest in D.

female slowly dies. However, active spawning has not been observed very frequently because females with egg-swollen bodies are seldom seen. Spawned out and partly spawned out females are quite commonly observed spawning in the field and in the laboratory. This tends to indicate that the initial and most active spawning takes place at night early in the season.

Entosphenus

The actual spawning, as nest building, was more intense for Entosphenus than was observed in Lampetra. The male grasps the female very firmly on the top of the buccal disc or head leaving tooth impressions from his sharp teeth. The vibrations that follow the twisting of the tail around the female and the arching of both bodies are very intense. Sex products are released into the cloud of sand particles and small stones. It was difficult to see the exact number of eggs released at each spawning, but 100-500 eggs was the estimated number released.

(k) Internal Fertilization

Much controversy exists as to whether or not intromission occurs in lampreys as reported by Dean, Basford, and Summer (1897) and Loman (1912). Observations on Salmon River lampreys agree favourably with Hagelin (1959) and show clearly that internal fertilization is impossible because of the position of the bodies during the spawning act (Fig. 42D, 44D, and 45). The farthest distance posterior that the tail of the male can stretch, yet still encircle the female's body, is to the second dorsal fin swelling. When the tail is wound

in this position the urogenital openings are still several centimeters from each other. This is so in both Lampetra and Entosphenus (Fig. 45, distance A). Intromission does not occur in British Columbia lampreys.

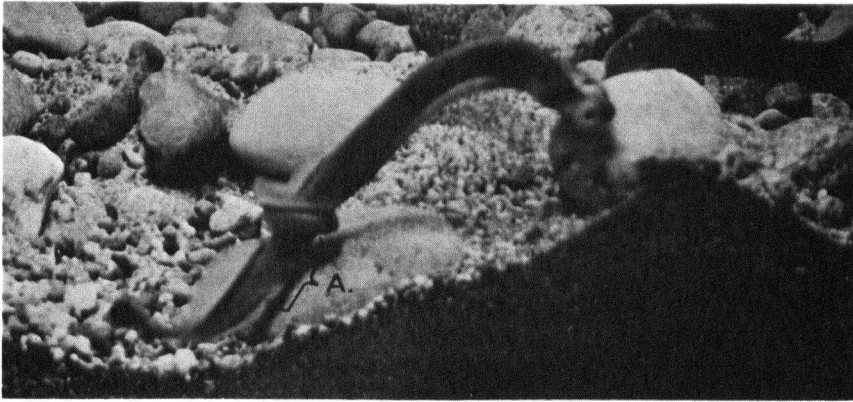


Fig. 45 Spawning Lampetra showing the distance (A) between the urogenital openings during the spawning act.

(1) Length of Spawning and Post Spawning Period

It was difficult to differentiate between the spawning period and the post spawning period. It was possible to tell when females had released most of their eggs because their abdomens became transparent during spawning. Most females died within two weeks of the release of all their eggs, but spawning and post spawning period duration depended upon water temperature (Fig. 46). Usually less than ten eggs remained in the body cavity when the female died (Table 3). The time when males released all their sperms could not be determined without dissection. The post spawning period could not be differentiated

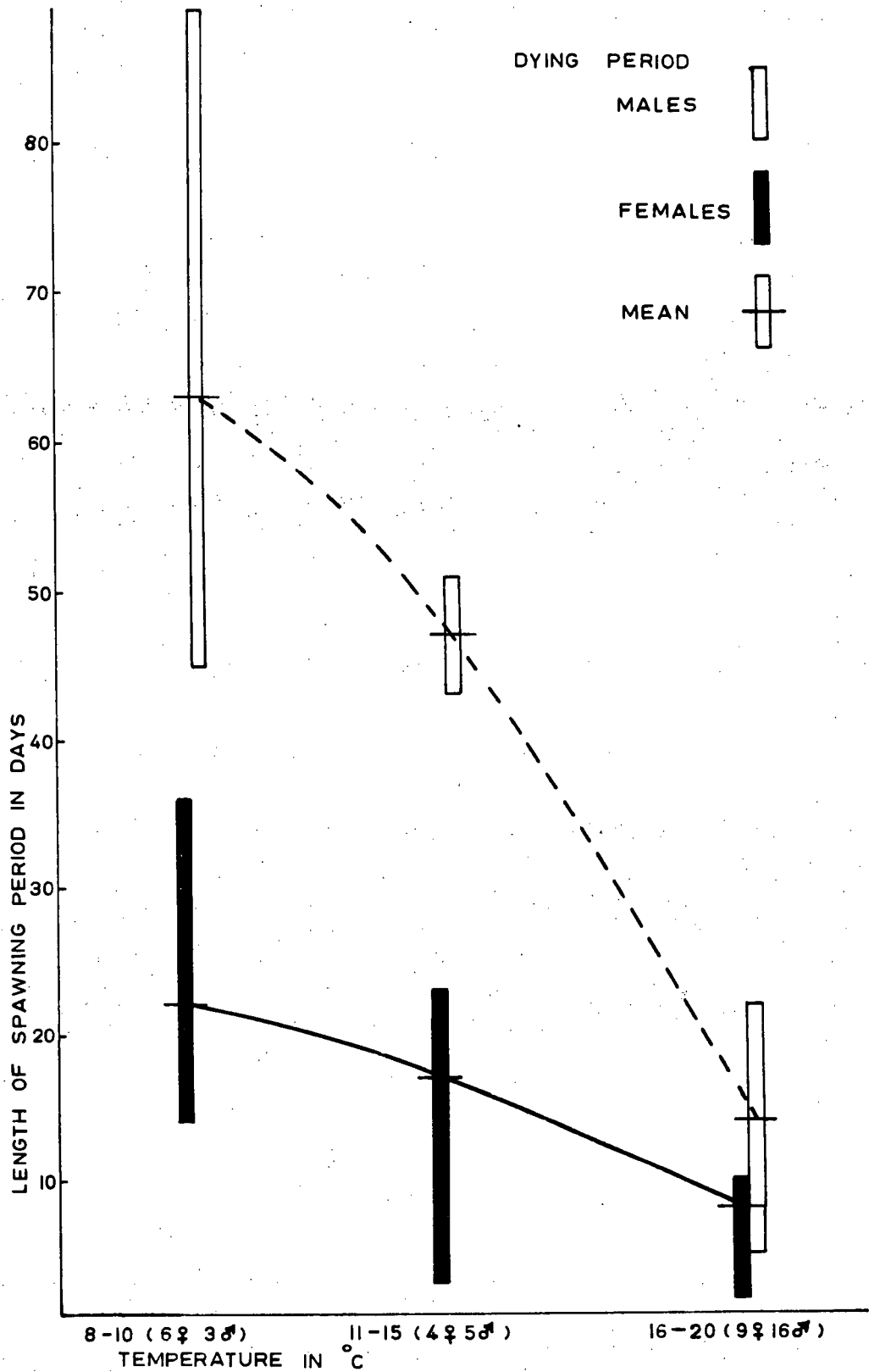


FIG. 46. LENGTH OF THE SPAWNING PERIOD AT DIFFERENT TEMPERATURES FOR *LAMPETRA PLANERI* OF THE SALMON RIVER.

from the spawning period in males. Most males died with much of the sperm still remaining within their bodies.

Hagelin and Steffner (1958) reported that all river lamprey died about one week after the last eggs were deposited. These researchers attribute death to a long fasting period prior to spawning and a rapid use of energy during spawning. Numerous dead adults in a spawned out condition were collected from the 20th. of March to the first week in June from the Salmon River. All Salmon River lampreys kept in aquaria died.

The spawning period and post spawning period for L. planeri from the Salmon River extended from the middle of April to the second week in July. Animals were continually reaching maturity and dying throughout this period.

Dying and spawned out adults are characterized by marked reduction in the abdomen diameter, fading and blotched colouration, and blood filling the tissues of the fins, buccal disc, and region of the vent. A number of dying adults have been observed going through rapid twisting movements and convulsions. The bodies of dead lampreys are covered with fungus within a day of death in the river and in the aquarium. Gage (1928) and Applegate (1950) observed that dead and dying Sea Lampreys are deposited in deep and silted pools.

Entosphenus

The spawning period seemed to extend from April 20 to June 22 during 1962 according to specimens observed on the Salmon River. Nile Creek specimens were caught in spawning condition as late as the first week in July while spawning

movement was recorded as early as March from 1948 to 1954.

Mattson (1949) reported Entosphenus spawning on the Willamette River, Oregon, in June and July. Aquarium spawning and holding experiments were not carried out for Entosphenus.

(m) Communal Spawning

The communal and gregarious sharing of spawning nests and partners is extremely interesting to analyse as to function and significance. This behaviour of L. planeri has usually been observed during the beginning of the season or when a number of ripe animals have just been introduced into an aquarium. Six communal spawnings have been observed in the stream during April and early May, but none were observed during June or early July. This may be due to a decrease in the density of the spawners in the later part of the season.

As many as twelve adults have been observed in one nest and all seemed to be participating in the spawning. There was usually much mobility within the group, and when communal spawning was observed for a number of hours, the group broke up into three or more groups, each spreading out to neighboring nests with spawning occurring in each group. Ten minutes later the majority of them were back in the first communal nest. There seemed to be some rhythm of spawning where two or three pairs would be spawning very close to each other. Then most of the group would leave the nest to visit other nests, but they would return in about five minutes to resume digging and spawning.

Aquarium observations bear out the notion of rhythmic

communal spawning. The males are the active participants in nest construction and enlargement of the nest between spawnings, and the females usually take a less active part in the procedure. Communal spawning represents the highest activity level in spawning which occurs for a period of one day or less.

A particular behaviour is associated with communal spawning that has never been reported before. That is the coiling of either a male or female around a spawning pair or around two spawning pairs, or coiling near a pair (Fig. 47). This behaviour was examined with the aid of a motion picture and it was concluded that it may serve to bind a group of stimulated bodies to release sex products at one time, but whether or not the coiling adult did release sex products is not known. However, the coiling individual was seemingly stimulated by the vibrations. It could serve to hold the sex products together and ensure fertilization, or it may be simply a vibrating and coiling reaction of a number of highly stimulated animals when one pair sets off the trigger mechanism of the spawning act.

It is suspected that during communal spawning a chemical releaser stimulates lampreys to congregate at a communal nest. A ripe unspawned female was introduced into a tank containing four males and she was removed after a five minute stay. The presence of the female apparently caused the males to become very active and they lifted rocks and dug for a two hour period after the female was removed from the tank. Ripe unspawned females seemed to be always present in the

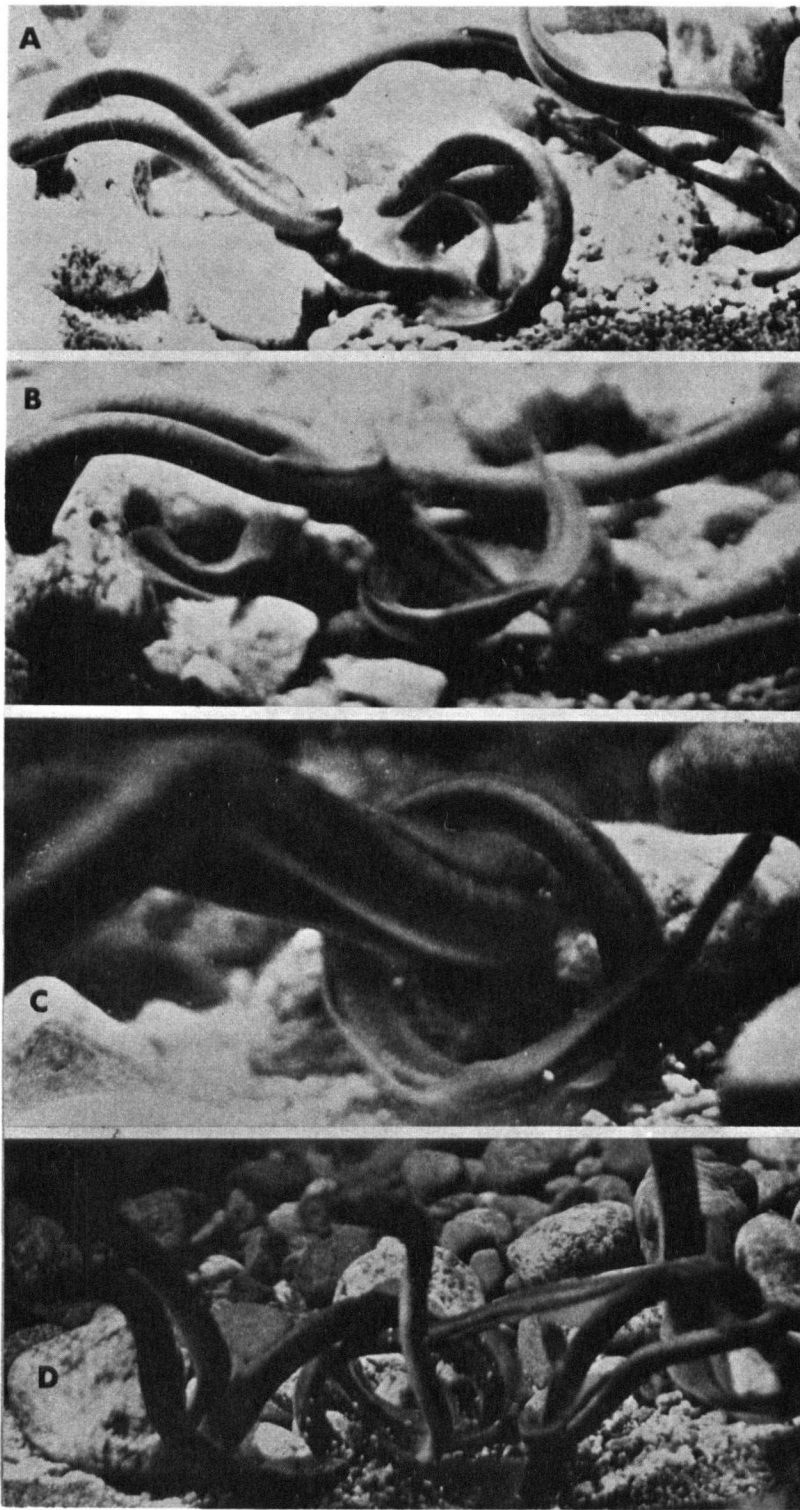


Fig. 47 Coiling action during communal spawning. A male or a female coils around the spawning pair (centre of each picture).

communal nest. This suggests that females may give off a chemical releaser that congregates a number of lampreys to one nest for communal spawning.

Communal spawning has been recorded for P. branchialis, brook lamprey of New York, by Gage (1893 and 1928) when eight to ten animals spawned in one nest. Hubbs and Trautman (1937) reported from five to nine individuals per nest for Ichthyomyzon greeneyi. Schultz observed nine L. planeri in a communal nest in Washington State near the start of the spawning season. Dendy and Scott (1953) reported from five to twenty lampreys in a communal nest for Ichthyomyzon gagei but they observed great variety in numbers.

Entosphenus

Communal spawning was observed in the Salmon River on one occasion when two large Entosphenus (larger than 550 mm.) were seen in one nest with three smaller individuals (less than 250 mm.). However, the spawning act was not observed although rock lifting and digging were. Later dissection revealed the animals were in a spawned out condition. The difference in size between the two size ranges seemed to have no effect on communal spawning. A large female and a small male were collected and spawned artificially the following day. The few eggs that were obtained hatched in the laboratory. Communal spawning does occur in Entosphenus but usually the population on the Salmon River was so small that in some years only pairs or single individuals were collected.

(n) Displacement Behaviour

Spawning "displacement" behaviour occurs most frequently "when a central nervous mechanism has been stimulated but cannot use its normal outlet because the particular activity is not possible." (Baerends 1957). In lamprey spawning behaviour there is a normal series of steps that each animal goes through before the sex act. If the animal starts spawning by proceeding through one or more steps, as digging a nest, but is prevented from completing the series, then a different "displacement" behaviour is observed. This "displacement" behaviour is quite different from the normal sequence of spawning behaviour. It usually takes the form of reverting to a lower step of the normal series, when the other partner is either not ready to complete the sex act at a particular time, or is absent. One partner is physiologically ready to spawn yet the other does not complete the necessary response when the sign stimulus is applied by the other partner. The energy is usually channeled into an action that is similar to, or reverts to, early spawning behaviour.

One form of displacement behaviour occurs when a single male or female has completed nest construction alone and no partner of the opposite sex is present in the nest to complete the spawning act. The intensity of digging is usually increased until the animal swims actively around the tank as if searching for a spawning partner. If the actively swimming adult is a male, he will seek out another lamprey and court the animal by moving his buccal funnel up the animal's body. If the

receiver is a male he will move away from the advancing male with quick swimming and wriggling motions. If the receiver is a female she will move from the gravel and swim around the tank and settle in the nest if she is ready to spawn. If the female is not ready to spawn she will remain burrowed or attached to the rock. The male responds by continually courting or gliding over her body with feeling motions with the buccal disc (Fig. 42B). On a number of occasions the male attached his buccal disc to the head, or brachial region of the female and swam or pulled her to the nest. Two spawned out and nearly dead females were observed being carried by the male to the nest. Once at the nest, the male proceeded to court and stimulate the female for ten minutes. The male attached to the female's head and wrapped his tail around her abdomen but the female did not respond with the undulations or vibrations of normal spawning. The intensity of the male's courting and attachments increased until the male went through the vibrations of spawning and tail twisting with sperm release without any female response or release. This continued for one hour until the female finally died, but the male continued to carry the female on to the nest and around the tank. The male left the dead female and burrowed deeply into the gravel on a number of occasions but returned to carry the female about the tank again. He finally left the female and reverted to construction of the nest by rapid digging.

Females were observed "searching" for a male after completing nest construction. When she located a male she

would court him with gliding motions similar to those used by the male (Fig. 48). Males usually responded by returning to the female's nest, but if not responsive they would burrow deeper under the rocks. Once in the nest, a responsive male would take the initiative and perform the spawning act.

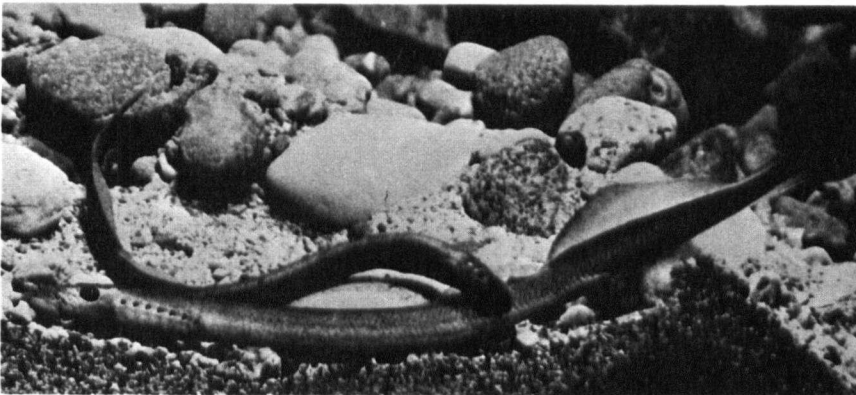


Fig. 48 A female courting a male by gliding along his body.

Females ready to spawn were observed courting other females by gliding up their bodies or attaching to the head of the other female and undulating the body. On one occasion one female arched the brachial region and vibrated rapidly while attached to another female, but the female never wrapped her tail around another lamprey. Two females kept in one tank released their eggs by grasping the glass and vibrating both bodies rapidly and close together in the sand. Females ready to spawn and unable to arouse a male lie for long periods with their bodies curved in the nest and undulating slowly. Occasionally the female will dig up the bottom of the nest, lift rocks or attach to the glass of the tank and vibrate her

body rapidly as in the spawning or digging action.

Males kept in a tank without females built nests and rested in them. A common behaviour during this time was the crooking of the tail as described by Hagelin (1959). Separated males tried to court other males but the receiver always moved out of the gravel quickly. Hagelin (1959) describes this action as one male repelling the other from the nest but it seemed more an action of one male not responding to the sexual advances of another male. Males kept together also displayed frantic swimming and searching of the tank. Males separated from females for a week immediately became active and started digging and rock lifting when a female was introduced into the tank for a short period.

(o) The Effect of Temperature on Spawning

Effect on Behaviour

Three tanks were set up to test the effect of different temperatures on behaviour. The following temperature ranges were established in the three tanks: 8-10°C., 11-15°C., and 16-20°C. The two cold tanks were arranged with chlorine-free circulating water to cool the tanks to the correct temperature. The warmest tank was a closed system with aerated water at room temperature.

All the animals in the warmest tank (16-20°C.) began to dig nests after the first day of relocation from their Salmon River spawning area. Communal spawning was observed after the first day of introduction as ripe females were present. Nest construction was usually initiated by the males with the females offering some assistance after the nest was started.

The males usually left the nest for short periods after each spawning act while the females remained in or near the nest. Displacement behaviour was very common in the males.

The males buried into the gravel for the first day in the 11-15°C tank while the females rested attached to rocks or the aquarium glass. Rock lifting and digging was observed in most females during this time. The males left the gravel on the second day for short periods to help the females with nest construction. The males' activity was spasmodic as they spent most of each day buried in the rocks. Females displayed displacement behaviour when males were buried or inactive. Spawning was observed in pairs and communally on the second day after introduction. Paired spawning and nest construction initiated by both sexes was observed at frequent intervals during the first week. Two females died at the end of the first week and the two remaining females were in a spawned out and emaciated condition and showed no more spawning action until death. The remaining males exhibited displacement behaviour after the active females died.

The males remained hidden under stones in the coldest tank (8-10°C) for two weeks after introduction. Females hid under rocks for the first week but then they began to take periodic exploratory excursions around the tank. Occasionally nest construction was started by females during the second week. At the end of the second week a male occasionally left the gravel to spawn with females that were actively occupying and digging nests. Females exhibited courting and displacement

spawning behaviour toward both males and females at this time.

Communal spawning was observed and filmed on the 14th day after introduction and it occurred between six females and three males. Occasionally one of the males burrowed in the gravel would join the spawning group only to return to the gravel shortly. The females initiated the nest building and contributed most of the labour while the males undertook little rock lifting and digging. After each spawning act the female left the nest while the males remained in the nest which is directly opposite to the behaviour at high temperatures. The spawning act was observed every 3 to 30 minutes depending on the number of males in the communal nest. The females left the communal nest after each spawning act or coiling action while the males remained in the nest. All the females returned to the nest at regular intervals to dig and spawn. Active communal spawning took place over a 14 hour period and began to decrease in intensity after this because most of the males went into hiding again and the ripe females had released most of their eggs.

Paired spawning was observed for the week following communal spawning with displacement behaviour being displayed very frequently by the females. Little digging and no spawning was observed during the 12-16 of May for the males and the females in the cold tank. Two of these inactive males and females were removed from the cold tank and placed in cold water that was allowed to warm gradually to room temperature (16-20°C). The two males became very active when the

temperature reached 14-16^oC . They swam around the tank and immediately began frantically to dig two separate nests. Spawning was observed immediately upon nest completion and for the next day. The males left the nest after each spawning act while the females remained in the nest. However, the females were in a spawned out condition during the second day and did not have much energy to contribute to spawning during this time. Both females died the second day after transfer to the warm tank. Displacement behaviour was frequently displayed between the two males and between the males and the dying or dead females. On the second day the males were returned to the cold tank. Their active behaviour stopped immediately and they burrowed into the gravel for the next two days.

The females in the cold tank were nearly all dead after one month from collection; only occasional digging or spawning was observed. The males displayed frequent displacement behaviour after the females died. Periodic active swimming at the surface was observed at intervals as was hiding in the gravel. After 50 days from introduction the activity of the males decreased and all digging activity stopped. The low temperature had a definite effect on reducing the activity and changing the behaviour of the lampreys.

Effect on Length of Post Spawning Period

Hardisty (1961) and Zanandrea (1961) suggest that Brook Lamprey die soon after spawning and that males live longer than females during the spawning season.

Lampreys from the Salmon River were placed in

experimental laboratory tanks at three different temperatures and the date of death was recorded for each individual (as described above). The six females kept at the coldest temperature (8-10°C.) died from 14 to 36 days after collection, but those kept at 11-15°C. died from 4 to 23 days after collection, and those kept at 16-20°C. died from 3 to 10 days after collection (Fig. 46).

The males lived for a significantly longer time than the females over all three temperature ranges. At cold temperature (8-10°C.) the males survived for more than twice the length of the post spawning period as shown by the females. Low temperature increases the post spawning period of both males and females, while warm temperatures shorten the post spawning period (Fig. 46).

C. Ammocoete Life

1. Method of Hatching Lamprey Eggs

Lampetra eggs were collected from the gravel of the spawning tank in 1962, and placed in nylon cloth baskets. These 4 x 4 x 4-inch baskets were suspended in a five-gallon aquarium at room temperature (16-20°C) and an air stone circulated the water in each container. The time of hatching and general behaviour of the young ammocoetes was observed. Some eggs were allowed to hatch and develop in the gravel.

In 1963, eggs from mature Lampetra and a spawned out Entosphenus were fertilized and placed in nylon baskets in a five-gallon glass aquarium (16-18°C. temperature), and in a 15°C. thermostatically controlled fifteen-gallon plywood tank.

Air stones were supplied to the baskets at each temperature and five days after hatching, a one-inch layer of recently collected Salmon River silt was added to the baskets. Observations of hatching time, absorption of yolk sac, and behaviour of young ammocoetes were recorded.

2. Embryonic and Early Larval Life

The lamprey egg, when laid, is sufficiently dense to sink quite rapidly in fresh water (Hardisty 1957). The egg is adhesive at this time and attaches itself firmly to any surface that it contacts. The perivitelline space between the chorion and the ovum fills with water and the egg loses its adhesiveness two hours after it is released. Fertilization will not take place after one hour from the release of the egg (Hardisty 1957).

Cleavage takes place rapidly in lamprey eggs, the blastula forming during the first three days (Piavis 1960, Hardisty 1957). Piavis (1960) describes 18 stages of the sea lamprey embryo before it developed into a larva at 33 to 40 days. The development of Lampetra embryos was compared to the stages and description outlined by Piavis.

3. Hatching Results

The 1962 Lampetra eggs hatched after 15 days at 16-20°C, and at 30 days the larvae were actively burrowing into the bottom of the containers. The recently-hatched and older larvae were very sensitive to light, as digging and movement could be initiated by exposing them to a bright light or artificial light. Young (1935) and Harden-Jones (1955) have shown that the ammocoete's tail and other parts of the body

are particularly sensitive to light and that the animals show a photokinesis. This is a locomotory reaction to light, bearing no directional relationship to the source of stimulation, and the movement is random when exposed to light. The young embryo remained at the bottom surface of containers for the first two weeks before development was complete, whereupon it burrowed into the mud to begin the larval fossorial life. Two larvae remained alive until November 8 (hatched May 29) and attained a length of 18 mm..

In 1963 a better control of temperature was obtained and eggs of both Entosphenus and Lampetra were hatched. Lampetra hatching started after 13 days at 17°C and after 15 days at 15°C. Hatching was usually complete after 3 days from the first sign of hatching. Entosphenus eggs started hatching after 19 days at 15°C. and the larvae were 1 to 2 mm. longer than Lampetra after 40 days in the same temperature bath. Naturally spawned eggs were hatched at 8-9°C. in 25 days. Carl (1945) reported that it took 28 days to hatch Lampetra at 10-20°C. from Holmes Creek near Cowichan Lake. Hardisty (1957) performed extensive hatching experiments on English Brook Lamprey eggs, and found that they hatched in 17 days at 11-12°C. and in 21 days at 9-10°C.. He hatched eggs successfully in 3-5°C conditions after 8 weeks. The stages of embryonic development of Entosphenus and Lampetra were very similar to that described by Piavis (1960) for the sea lamprey.

Gage (1928) hatched sea lamprey in nine days at 60°F, Wigley (1959) in 14 days at 60°F, and Lennon (1955) in 10 to

16 days at 70°F . Therefore, temperature directly controls lamprey egg hatching time and development, but there seems to be only slight differences in hatching time and development between the two species.

The developing Entosphenus and Lampetra embryos, one week after hatching, became more sensitive to light. The yolk in the intestine began to disappear after the second week from hatching (20-35 days). The mouth became connected to the digestive tract and the branchial pouches formed. The embryos developed bilateral eye spots and the animals began to burrow, marking the end of the embryonic stages and the start of the larval or ammocoete stage (Piavis 1960).

4. Burrowing and Free Swimming Action of Larvae

Observations on larvae in the laboratory showed that they began to burrow after 20 days, but in the stream they are already burrowed in the gravel. In the stream, the larvae leave the gravel after two or three weeks from hatching, are carried downstream by the current and are deposited in the fine mud of pools. Gage (1928) believed that the larvae leave the gravel after the yolk is used up, and then migrate downstream to the mud banks where the microscopic food supply is more abundant. Thomas (1963) shows that there is a circadian activity rhythm in ammocoetes kept under 3 different day lengths. He found that ammocoete activity occurred during the second hour of darkness. Enequist (1937) showed that some free-swimming activity took place at night. Kleerekoper et al. (1962) showed that ammocoetes exhibit a diurnal periodicity within the mud

and at the mud surface.

5. Collecting Emergent Ammocoetes Below Spawning Nests

Collections were made in the Salmon River to determine when newly-hatched larvae leave the gravel and migrate downstream. Table 5 summarizes the results of collecting larvae in different bottom conditions on the Salmon River during July 26-28, 1962.

Larvae (7-10 mm.) emerge from the gravel chiefly during the dark (22 and 51 larvae were collected overnight with the Surber sampler; Table 5). None were collected by the same device during the four daylight periods.

Trays filled with mud and placed in the stream in various places collected more larvae during the night than during the day (Table 5). This substantiates the results of the Surber Sampler in indicating a definite migration or emergence of recently hatched larvae from the gravel during the dark hours. The tray collections seem to indicate that the larvae, after being swept from the gravel into a pool, bury into the mud bottom throughout the pool area during darkness, regardless of the bottom type present. It appears that some rhythmic stimulus initiates swimming activity to remove the larvae from the gravel. The current then carries the larvae downstream until the current is reduced and the larvae then bury themselves into the bottom.

6. Bottom-type Preference

Emergent Ammocoetes

A plastic tray with compartments filled with different bottom sediments was placed in the Salmon River

Table 5 Collection of emergent larvae from the Salmon River
July, 1962. Temperature 10 to 19°C.

Pool tray #	Surface current speed	Water depth	Bottom type	<u>No. of larvae collected</u>					
				<u>600 hr.</u>		<u>1400hr.</u>		<u>2200 hr.</u>	
				July:					
				27	28	26	27	26	27
1	.5 ft/sec	1'	Mud	2	3	1	0	0	0
2	1 "	11"	Sand	8	5	0	0	0	3
3	.2 "	2'	Leaves & mud	5	1	0	2	0	2
4	.5 "	2'	Rocks & mud	21	5	0	0	0	0
5	.5-1 "	2'	Rocks & mud	0	0	0	0	0	0
Modified Surber Sampler	3 ft/sec	1.5'	Riffle & gravel	51	22*	0	0	0	0

* a one year larvae was taken in the Surber sampler.

with no current flowing over the bottom materials (Fig. 49). Lamprey larvae (8-12 mm.) were placed in the holding trays (Fig. 49E) and the apparatus was allowed to adjust to stream temperature for a 30-minute period. Individual ammocoetes and water were taken from the holding trays with a suction tube and the contents were released into the centre of each tray. The time taken for each ammocoete to burrow into the bottom was recorded by a stop watch and additional burrowing behaviour was noted. Similar procedure was followed with a current of 0.5 ft./sec. The observations were made from July 26-28, 1962. Table 6 summarizes the results of the bottom preference by larvae that have recently hatched in the Salmon River. The



Fig. 49 Experimental trough used to test the burrowing capacity of small ammocoetes.
 E- holding tray A- mud B- sand
 C- small gravel D- no cover
 (measurements in cm.)



Fig. 50 Experimental trough to test the bottom preference of larger ammocoetes in the Salmon River.
 A- mud B- sand C- holding tray.

tanks were placed in the Salmon River to try to duplicate natural conditions, but as the emergence observations showed, movement of ammocoetes usually takes place in the dark. It should be borne in mind that for these observations the time to bury would be much shorter in the light because the ammocoetes show a photokinesis.

A current greater than 1 ft./sec. carried all larvae from the tank regardless of the bottom type present. The larvae buried easily into the mud when no current was present, but the sand and gravel offered resistance to the larvae. They burrowed with great difficulty particularly in the sand. The bare bottom of the tank and continuous exposure to light caused the larvae to swim about continuously with their heads pointed to the bottom and their tails vibrating perpendicular to the bottom. At currents of 0.5 ft./sec. larvae maintained their position and buried their heads easily in the mud, but did not bury the whole body until later because of the effect of current drag on the body. In sand, the larva tried to maintain position by forcing the head into the sand, but this was impossible, so the larva was usually swept from the tank soon after liberation. The gravel bottom in the current enabled the larvae to maintain position better than in the sand because they could force their heads and bodies into the spaces between the rocks and thus escape the force of the current. Later they could squeeze between the rocks. They tend to bury themselves more quickly when the current is present because the current appears to stimulate the tail and thus forces the larvae to burrow completely below the surface.

Emergent larvae showed a definite preference for mud bottom in a current or in its absence. Larvae had the greatest difficulty burrowing into sand and most were unable to enter this bottom type. Gravel offered shelter for the larvae from current and they could burrow slowly into this bottom-type.

Table 6 Bottom type preference of emergent larvae from the Salmon River.

Time: s = seconds; m = minutes

Bottom type	Time to bury completely	Time to bury head only	Time in which animal swam or was swept from tank
<u>Mud (.004cc)</u>			
No current	30s, 10s, 3s 5s, 8s.		
Current of 0.5 ft./sec.	5s, 10s.	5s, 15s, 10s.	
<u>Sand (.005cc)</u>			
No current	4m, 5m, 5m, 4m, 3m.		
Current of 0.5 ft./sec.			5s, 5s. 5s. 15s, 10s.
<u>Small gravel (1-.5cc)</u>			
No current	5m, 2m, 1m, 4m, 3m.		
Current of 0.5 ft./sec.		15s, 10s, 10s.	5s, 5s.
<u>Bare bottom</u>			
No current	Active swimming around the tank for more than five minutes (5 trials).		
Current of 0.5 ft./sec.	Swept out of tank in less than 5 seconds (5 trials).		

Harden-Jones (1955) performed experiments with glass rods in an aquarium containing ammocoetes that seem to indicate that a thigmotaxic response by the ammocoetes may play some role in bottom preference. Scholl (1959) reported that water velocity over ammocoete burrows was 2.07 ft./sec. This appears incorrect because sediments do not form at such a velocity and can only be found over ammocoete beds during flooding. Thomas (1959) reported, "no ammocoete could burrow into an infinitely soft bottom if it could not breast the current over it." Ammocoetes from the Salmon River less than 40 mm. can not penetrate the softest bottom with a current over 1 ft./sec., while adults of L. planeri cannot maintain their position in the stream with current above 2 ft./sec..

Larger Ammocoetes

Ammocoetes (10-15 mm.) were introduced into the centre of the middle partition of an aluminum trough with no current (Fig. 50). A current of 1 ft./sec. was introduced into the trough and ammocoetes were introduced 4 inches from the upstream end of the tank. The time and position for each ammocoete to bury into the bottom substrate was recorded (Table 7 and Fig. 51). Sand (.005 cc.) and mud (less than .004 cc.) were used as the bottom types for the observations. The observations were recorded on September 15, 1962.

With no current in the trough the small and medium sized larvae buried into the mud quicker than the larger larvae. In the sand substrate the large larvae buried the quickest and the small larvae had the greatest difficulty in penetrating the

Table 7 Ammocoete burial rate in the sand and mud in a trough suspended in the Salmon River (10°C.)

Time: s = seconds; m = minutes

<u>No current</u>	<u>Time to bury in the substrata</u>		
	10-15 mm. larvae	25-30 mm. larvae	40-50 mm. larvae
<u>Sand</u>	1m, 2m, 2m, 1m, 2m	18s, 7s, 7s, 12s, 10s	9s, 10s, 9s, 8s, 10s
<u>Mud</u>	9s, 8s, 8s, 10s, 8s	7s, 11s, 7s, 10s, 8s	11s, 28s, 15s, 20s, 14s
<u>Current</u> 1ft./sec.			
<u>Sand</u>			3m, 1m
<u>Mud</u>	14s, 16s, 20s, 18s, 15s	16s, 14s, 30s, 17s, 13s, 32s, 14s	46s, 1m, 18s
Time in which animal swam or was swept from tank by current			
<u>Sand</u>	7s, 8s, 6s, 7s, 7s, 8s, 7s, 6s, 8s, 7s	5s, 1m, 6s, 18s, 4s, 8s, 7s, 2m, 41s, 20s	10s, 6s, 10s
<u>Mud</u>	7s, 8s, 6s, 8s, 8s	6s, 3s	6s, 5s

sand. However, one and one half months prior to this, the young of the year could not penetrate the sand. When the current was introduced only the largest larvae could penetrate the sand. Some of the smallest larvae could penetrate the bottom of mud with a current in the tank but the medium larvae could bury better in the current. The larger larvae seem to swim some distance before they bury themselves while the smaller larvae seek the bottom immediately on release. Thomas (1963) found similar swimming movements in ammocoetes of the sea lamprey. Macdonald (1957) performed substratum preference experiments on sea lamprey larvae using seven different bottom types and three sizes of ammocoetes. He found that extremely coarse-grained or extremely fine-grained substrata were seldom used by ammocoetes. The smallest ammocoetes selected the coarser-grained substrata, especially the gravel, while the larger ammocoetes selected the finer-grained substrata, especially the sand and silt. These are contrary observations to those based on collections taken in the stream. Macdonald did not have a current in the tank so the smaller larvae probably sank to the bottom and fell between the large particles of the gravels and hence could not seek further for a suitable bottom.

7. Intestine Analysis of Ammocoetes

Five ammocoetes differing in size (30-130 mm.) were selected from each of the April, June, October, and December collections. A ventral slit was made in the body wall along the length of the body. The intestine was cut posterior to

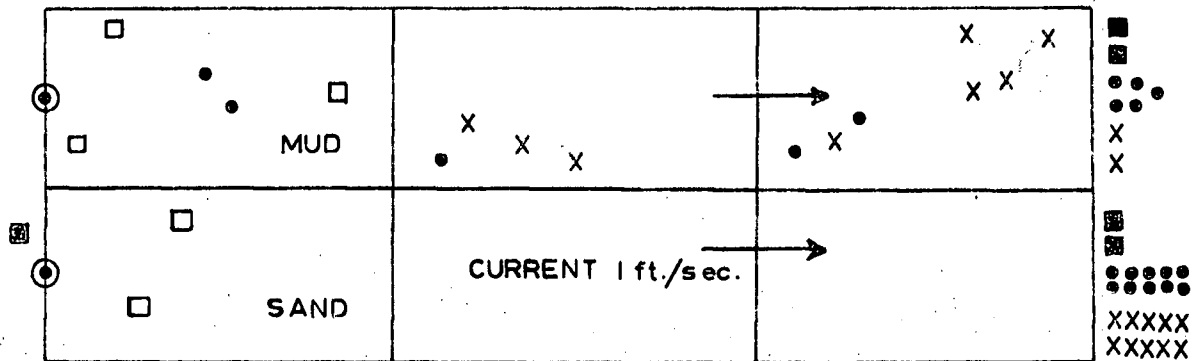


Fig. 51 The position that the ammocoetes burrowed in the bottom of a trough with a current of 1 ft. per second at the surface.

- - 10-15 mm. larva
- X - 25-30 mm. larva
- - 40-50 mm. larva
- ⊙ Point of introduction of larva
- Swam from tank without seeking bottom

the liver and the complete intestine removed. The contents of the intestine were scraped from the tissue and collected on a glass slide. The contents were mixed with two drops of water, covered with a cover glass and observed under a microscope (oil emersion). An exact quantitative estimate of abundance was not determined because the organisms could not be randomly distributed throughout the field. However, an estimate of relative abundance was made with 10 representing the greatest abundance and 1 representing less than 10 organisms in each intestine. Identification of the genera of the organisms was done with the assistance of Dr. J.R. Stein of the Department of Biology and Botany, University of British Columbia.

Ammocoetes differ from most larval fishes in that they are filter feeders and have no discrete stomach. The organisms found in the ammocoete intestine are listed in Table 8. Diatoms were more than twenty times more prevalent than desmids and other Chlorophyceae. Fine organic material

from decaying plant remains was prevalent in the fall and winter samples. Nematode and mollusc larvae, radiolarians, and other protozoans were observed on rare occasions.

Sand particles observed in the intestine of ammocoetes were smaller in size than the smallest diatom (6 u). The largest particles in the intestines were desmids such as Cosmarium (20 u).

Table 8 Intestine analysis of ammocoetes from the Salmon River

	<u>Apr. 28</u>	<u>June 10</u>	<u>Oct. 28</u>	<u>Dec. 16</u>
Relative abundance (Scale 1-10)	8	10	3	1
<u>Diatoms (Cyanophyceae)</u>				
<u>Navicula</u>	*	*	*	*
<u>Cymbella</u>	*	*	*	
<u>Synedra</u>	*	*	*	
<u>Tabellaria</u>	*	*		
<u>Nitzchia</u>	*			
<u>Hydrosera</u>	*			
<u>Gomphonema</u>	*	*	*	
<u>Stephanodiscus</u>	*	*	*	
<u>Diatoma</u>	*			
<u>Melosira</u>		*	*	*
<u>Surirella</u>		*	*	
<u>Cocconeis</u>			*	
<u>Frustulia</u>			*	
<u>Pinnularia</u>			*	
<u>Desmids (Chlorophyceae)</u>				
<u>Closterium</u>	*	*	*	*
<u>Ankistrodesmus</u>	*	*		
<u>Protococcus</u>	*			
<u>Cosmarium</u>	*			
<u>Gloeobotrys</u>	*			
<u>Scenedesmus</u>	*			
Nematode and Clam larve		*	*	

Digestion of the contents of the interior of diatoms occurs in the ammocoete intestine because chloroplasts are absent from the cells in the posterior intestine while they are present in the anterior intestine. Bacteria probably play an important role in the breakdown of plant debris in the intestine of the ammocoete.

Creaser and Hann (1929) examined the feeding habits of Michigan Brook lamprey and found diatoms and desmids present in all the specimens examined. Some protozoans were found on occasion and sand crystals and organic materials were also present. They found that the organisms present in the intestines came from the water, the sediments, and the detritus deposited in the quiet pools. However, none of the ammocoetes obtained any food from the stream bed even though they burrowed into it. Thus, organic remains and algae were utilized and filtered from the water flowing over the ammocoete beds. This food source is also used by insects and molluscs. The use of ammocoete intestines would seem to be an efficient and thorough method of collecting and surveying the diatom population of lamprey streams.

Schroll (1959) found that when diatoms were available they constituted the major portion of the food in the intestine and at other seasons of the year more detritus was consumed. He found from laboratory analysis that diatoms, marl and activated charcoal were actively ingested, while starch and wheat flour were less actively ingested. Animal foods as Paramoecium, chopped tubicids, and fish food were taken into

the pharynx, but did not appear in the intestine. The Salmon River and other ammocoetes examined feed almost exclusively on diatoms.

The feeding mechanism of lamprey ammocoetes has been described by Newth (1930) and Schroll (1959). Mucus was secreted by the endostyle and passed anteriorly and dorsally in lateral ciliated strands that are dislodged from grooves by the velum. These strands of mucus unite in the centre of the pharynx to form a conical net that selectively picks up diatoms and to a lesser extent desmids and detritus. The entangled food and mucus pass to the esophagus where cilia pass it to the intestine. Thomas (1963) used fluorescent dyes to show that a continuous current of water was normally drawn into ammocoete burrows.

8. The Protective Nature of the Lamprey Skin

The skin of the ammocoete and adult, though lacking scales and other hard protective plates common on fish, is specialized to give the animal adequate protection. The epidermis of the skin is covered with a layer of mucus secreting epithelial cells (Fig 52 e). The slippery nature of the skin and the wriggling motion of the lamprey's body makes it most difficult for most animals to grasp the ammocoetes or adults. Numerous adults have been collected with jaw marks, many lines across the body and regenerated tails, the consequences, presumably, of injuries inflicted by birds, crayfish, or other predators.

Stomach analysis and preliminary feeding experiments

were carried out to see if fish would eat ammocoetes.

The stomach contents of 20 coho salmon fry (July 27), 5 steelhead trout (July 27), 5 cutthroat trout (July 27), and 10 redbreasted shiners (Oct. 28) from the Salmon River were carefully examined for signs of lamprey ammocoetes. No lamprey ammocoetes were found in the stomachs of any of the fish examined. Hartman (personal communication) examined "hundreds" of salmonid stomachs on the Salmon River but found no incidence of lamprey remains. Thomas (1962) found lamprey remains in brown trout of West Wales to be present in less than 0.1% of the food and then only during the month of May. However, he found that 5.2% of eels had preyed on ammocoetes (June to September, 1.1% - 2.2% of the food of eels). Churchill (1947) examined 300 trout and 200 sucker stomachs from the Brule River and found no lamprey remains in the sucker stomachs, but he found remains in five trout stomachs, but these five were taken by rainbow trout in early July when lampreys were abundant on the spawning gravel. The lamprey remains from the trout stomachs indicate that the adults were in a spawned-out condition. In the post spawning adults the epidermis is sloughed off (Applegate 1950) so the remains eaten by the trout possibly did not contain the protective substance present in lamprey that is specific to certain fish.

Preliminary experiments to test whether salmonids would eat ammocoetes and to identify the location and nature of the protective substance were necessary to an understanding of the protective mechanism. Feeding experiments were set up to

determine whether salmonids would eat lampreys.

Ammocoetes (30-130 mm.) were introduced, just before regular feeding hours, to the surface of a concrete hatchery trough (20 x 20 x 20 ft.) containing 900 artificially-hatched coho salmon fry. Annelid worms the same size as the ammocoetes were introduced to the surface of the tank before and after the feeding with ammocoetes. The worms were immediately eaten by the first fry on contact. The ammocoetes were taken into the mouth of the fry but immediately spat out. In most instances an ammocoete that was rejected was immediately tasted by another fry and again released. Each ammocoete was tasted by at least 50 different fry during the 30 minute feeding period. A skinned ammocoete was introduced in a similar manner as the previous specimen, but it was always eaten by the first fry making contact with it. The skin from the skinned specimen was introduced but it was never eaten although it went through the same tasting and releasing procedure as the whole ammocoete. A worm was always eaten by the fry at the conclusion of each test. The tests were continued for a five-day period. No intact ammocoetes or ammocoete skins were eaten during the test, nor were the skinned ammocoetes refused by the fry. After the tests a live ammocoete survived in the tank after a two-day period, despite the constant attacks of the fry.

A second experiment was set up using 5 Salmon River coho fry and 2 cutthroat trout after holding for one week in a running water glass aquarium. These salmonids were fed the

the same combination of lampreys and parts thereof as in the first experiment. The same preference for skinned lampreys and a dislike for whole ammocoetes and the skin was noticed but by the fourth or fifth day the number of attacks was reduced to one or two at each feeding. After the completion of the tests the fry were starved for two days and very small ammocoetes (20-30 mm.) were introduced. Two ammocoetes were swallowed but did not go through the regular tasting behaviour that is common for coho fry.

Lamprey eggs were eaten rapidly by salmonids during feeding experiments. Spawning observations in the Salmon River showed that salmon and trout fry swam at the rear of lamprey nests and darted forward to eat eggs disturbed from the gravel by the digging and spawning adults. However, lamprey eggs are usually buried and covered by sand in the nest and digging proceeds upstream from the deposited eggs so few eggs are actually disturbed by further digging.

Young of the year and first year ammocoetes were eaten when fed to fry during daylight hours in the Salmon River. Emergent ammocoetes were eaten half the time by salmonid fry in a laboratory feeding experiment. Frozen brine shrimp was introduced before and after each feeding. From these observations it appears that salmonid fry will usually taste larger ammocoetes and objects before swallowing, but small ammocoetes are occasionally swallowed without tasting. Skin sections from the smallest ammocoetes revealed a decrease in the number of granular cells. This would account for their being eaten by

the fry occasionally while larger ammocoetes that contain more granular cells are not eaten. Small ammocoetes remain buried in the bottom sediments during daylight and escape predation by fish. They are susceptible to predation during flooding and during their daily circadian movements from the bottom, but they are probably protected by the toxic secretion from the granular cells at this time.

Stomach analysis from the Salmon River during emergence indicates that emergent ammocoetes are not eaten by fry. The emergent ammocoetes may not be seen or smelled by the fry when they emerge and bury during the dark.

Ten reidside shiners, 10 sticklebacks, and 5 spiny sculpins from the Salmon River were kept in aerated room temperature tanks and fed live ammocoetes on three occasions. The sculpins ate small ammocoetes on one occasion, but on two occasions they tasted and released larger ammocoetes. The shiners and sticklebacks never ate the ammocoetes but they did eat skinned ammocoetes on two occasions. One squawfish (Ptychocheilus oregonense) was fed live ammocoetes and ammocoete skin on ten different occasions. The ammocoetes and skin were immediately eaten on all occasions.

Pfeiffer (personal communication) fed ammocoetes and adults to blind cave fish (Anoptichthys jordani) and adult rainbow trout. The cave fish ate the lampreys while the rainbow trout did not. Perlmutter (1951) kept ammocoetes and eels in an aquarium and recorded that the eels burrowed into the mud of the aquarium and ate some of the ammocoetes.

The skin of a Lampetra ammocoete was preserved in Bouin's fixative and stained with Azan (Fig. 52). The site of the protective secretion appears to be in the granular (g) or club cells (c) of the epidermis. Pores (p) connect the granular and club cells to the surface, and the distasteful substance is discharged and distributed along the epithelium when the skin is compressed or bitten. Sections of ammocoete skin preserved in Bouin and stained with P. A. S. and Toluidine blue revealed that mucus was present in the uppermost layer of the epidermis and covered the epidermis. No mucus was present in the granular cell and club cells. Club cells and granular cells are very similar in structure and chemical composition. Pfeiffer (1960) suspected that the club cells move to the surface of the epidermis and become granular cells.

The author and a co-worker tasted live ammocoetes on numerous occasions and found that the skin was not distasteful when the ammocoete covered with mucus was placed in the mouth and over the tongue. However, when the ammocoete was pressed between the teeth and then placed on the tongue a bitter and unpleasant taste formed in the mouth. This substantiated that the distasteful substance in the skin does not come from the mucus but is probably forced from the skin when the skin is compressed or bitten. Thus, fish that tend to swallow their prey without tasting it would not respond to the protective substance in the skin, but those fish that taste and hold their prey in the mouth before swallowing would react to the skin secretion and release the lamprey.

Guibé (1958) reported that the skin of lampreys was probably poisonous but he did not present any evidence to validate the statement. The above experiments show that ammocoetes are probably protected from predation by salmonid and other fish in the Salmon River, by secretion from special cells in the skin.



Fig. 52. Epidermis of *Lampetra planeri* ammocoete (110 mm.) from the Salmon River, Dec. 28, 1962. (Bouin, Azan 5 μ , x 500)
 C - club cells; g = granular cells; p = pore of a granular cell; e = mucus secreting epidermal cells.

9. Distribution of Ammocoetes within the Stream

Analysis of monthly collections of ammocoetes made from many bottom types throughout the Salmon River in 1960-61

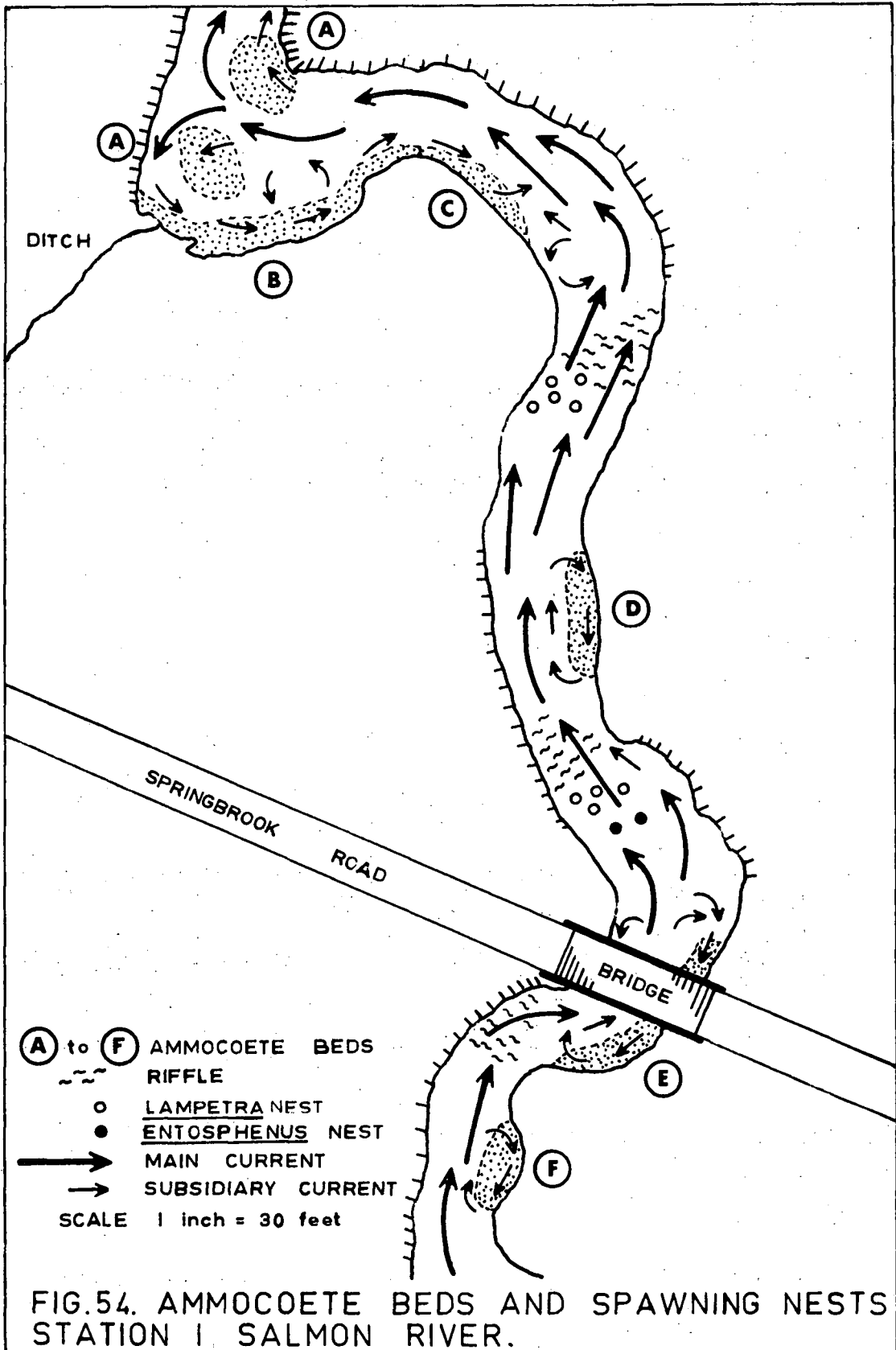
indicated a selection for particular bottom types and positions in the stream by different sized ammocoetes. In 1962 various habitats and ammocoete beds were sampled to see if there was any relation between size and substrate preference (Fig. 53).

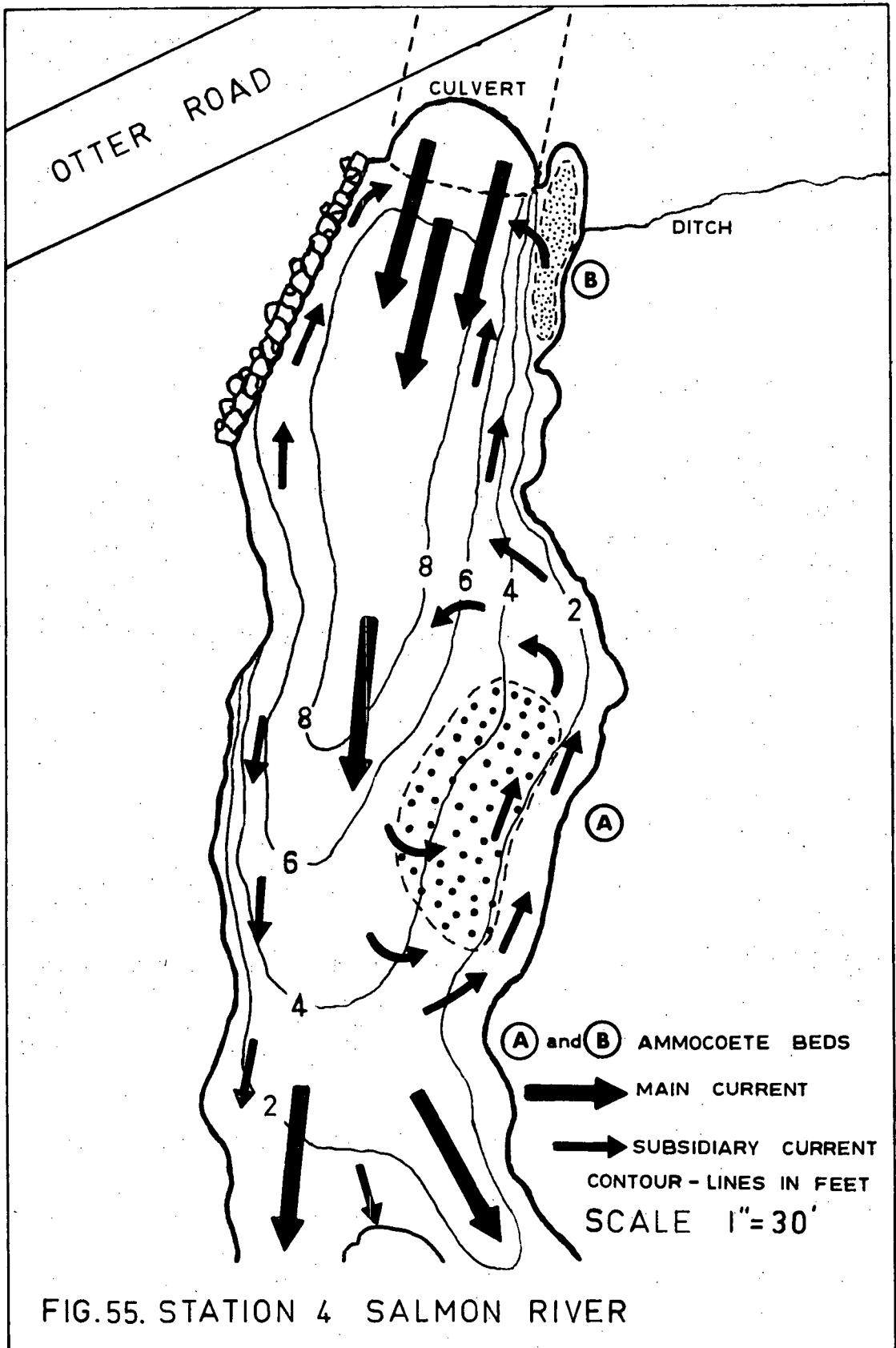


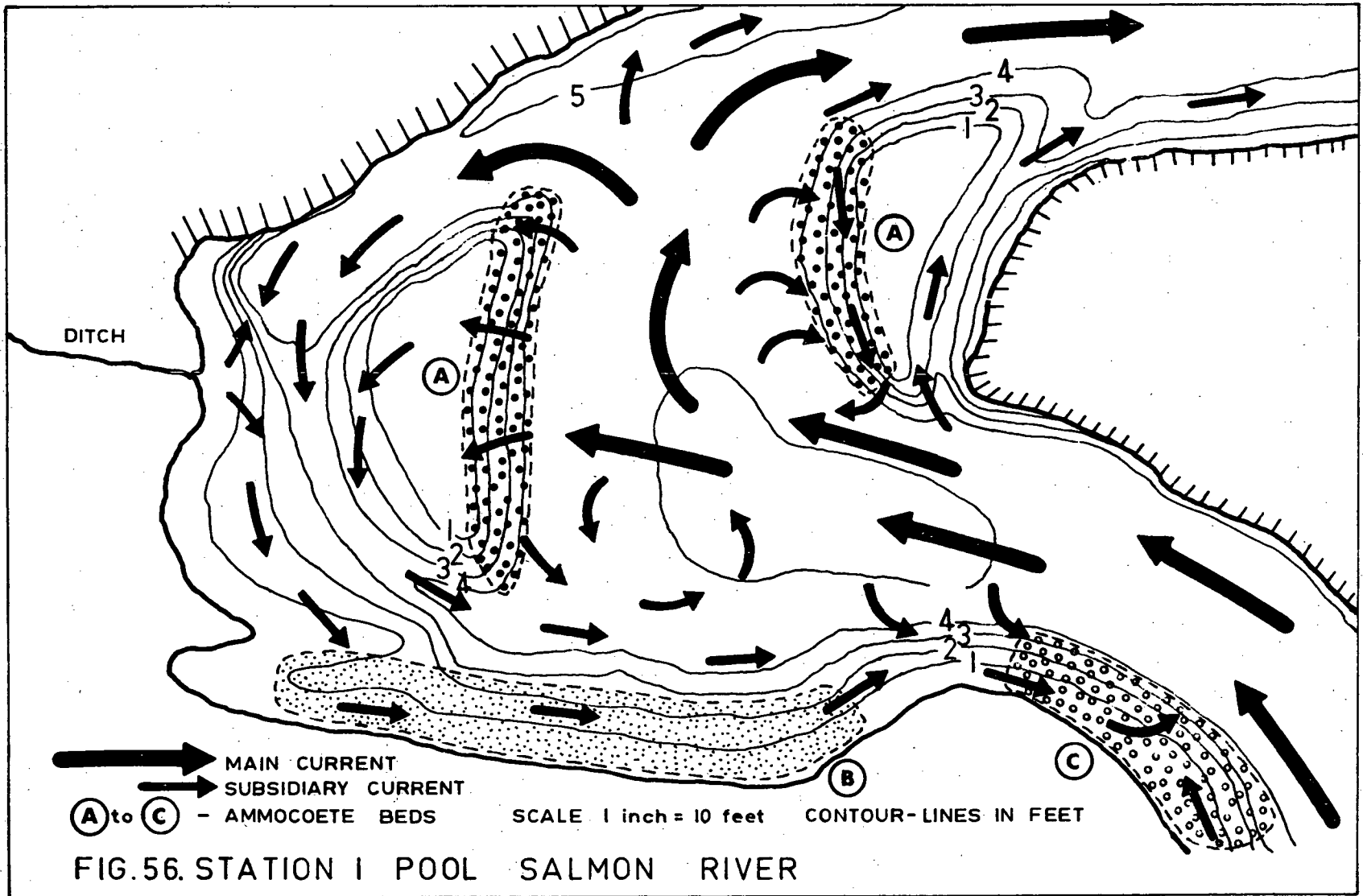
Fig. 53 Large pool where ammocoetes are deposited, Salmon River, station 1.
x - larger ammocoetes; o - smaller ammocoetes.

Large permanent ammocoete beds at station 1 and 4 (Fig. 3) were sampled. Fig. 54 shows the distribution of ammocoete beds in relation to the spawning nests and current at station 1. Ammocoete beds A, B, and C were relatively permanent during the study, while bed D was formed during the summer and beds E and F were formed during the winter months or after high flow conditions. Bed F dried up during the summer.

Ammocoete collections from the pools of station 1 and 4 from the Salmon River (Fig. 57 to 59) show that there is a significant difference in size of ammocoetes in the different







bottom types. Collections from the mud and silt near the bank (Fig. 55B and 56B) are represented by the histograms (Figures 57B, 57C, 58B, and 59A). First and second year classes predominate in the collections.

Ammocoetes from the sand and leaves from the deeper regions of the pool bottom (Fig. 55A and 56A) are represented by the histograms in Figures 57A, 58A, 58D, 59B, and 59C. These histograms show a significant difference from the mud bottom habitat. Second or older year classes predominate while the young of the year and first year larvae are less abundant. Fig. 59B compared to Fig. 59D shows that few of the young of the year and first year ammocoetes remained in the sand of bed A (Fig. 56) during the winter, they were present in September. Flooding possibly removed the smaller ammocoetes while the larger ammocoetes remained permanent residents.

The ammocoete bed C (Fig. 56) composed of sand and a very thin transient layer of surface mud contained the same size ammocoetes as those located in the fine mud and silt.

The above results clearly show that bottom composition, largely determined by current flow, influences the size distribution of the ammocoetes in the Salmon River.

The variation of size classes between ammocoete beds shows the need for sampling throughout the bottom habitat at various times of the year to obtain an unbiased sample of the population. Electric shockers have been used to collect ammocoetes in recent years but this does not produce good collections of the smaller ammocoetes (Churchill 1947), and scooping

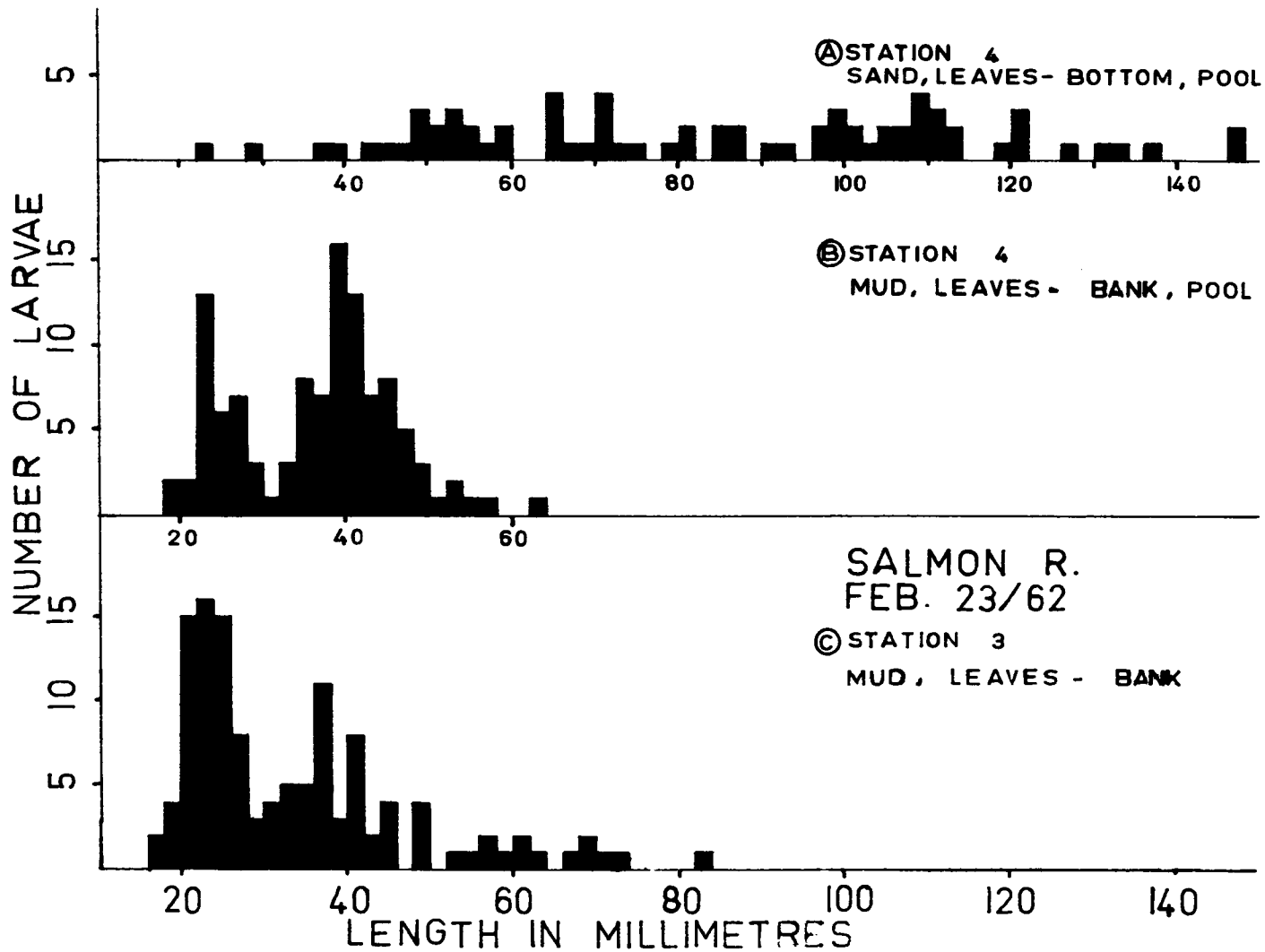


FIG. 57. LENGTH - FREQUENCY DISTRIBUTION OF L. PLANERI AMMOCOETES IN DIFFERENT HABITATS OF THE SALMON RIVER ON FEBRUARY 23, 1962.

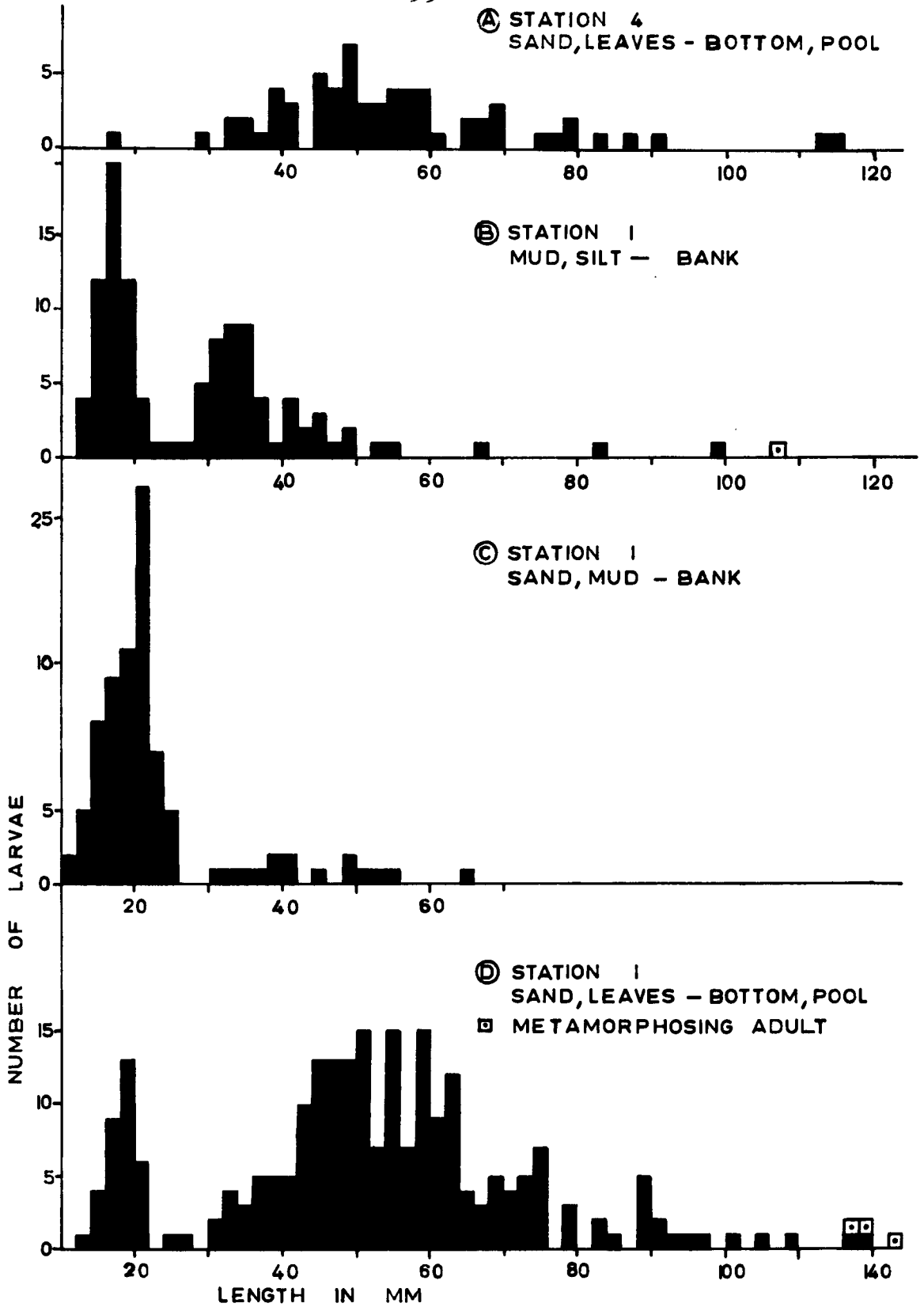


FIG. 58. LENGTH-FREQUENCY DIAGRAMS OF LAMPETRA IN DIFFERENT HABITATS OF THE SALMON, RIVER SEPT. 9, 1962.

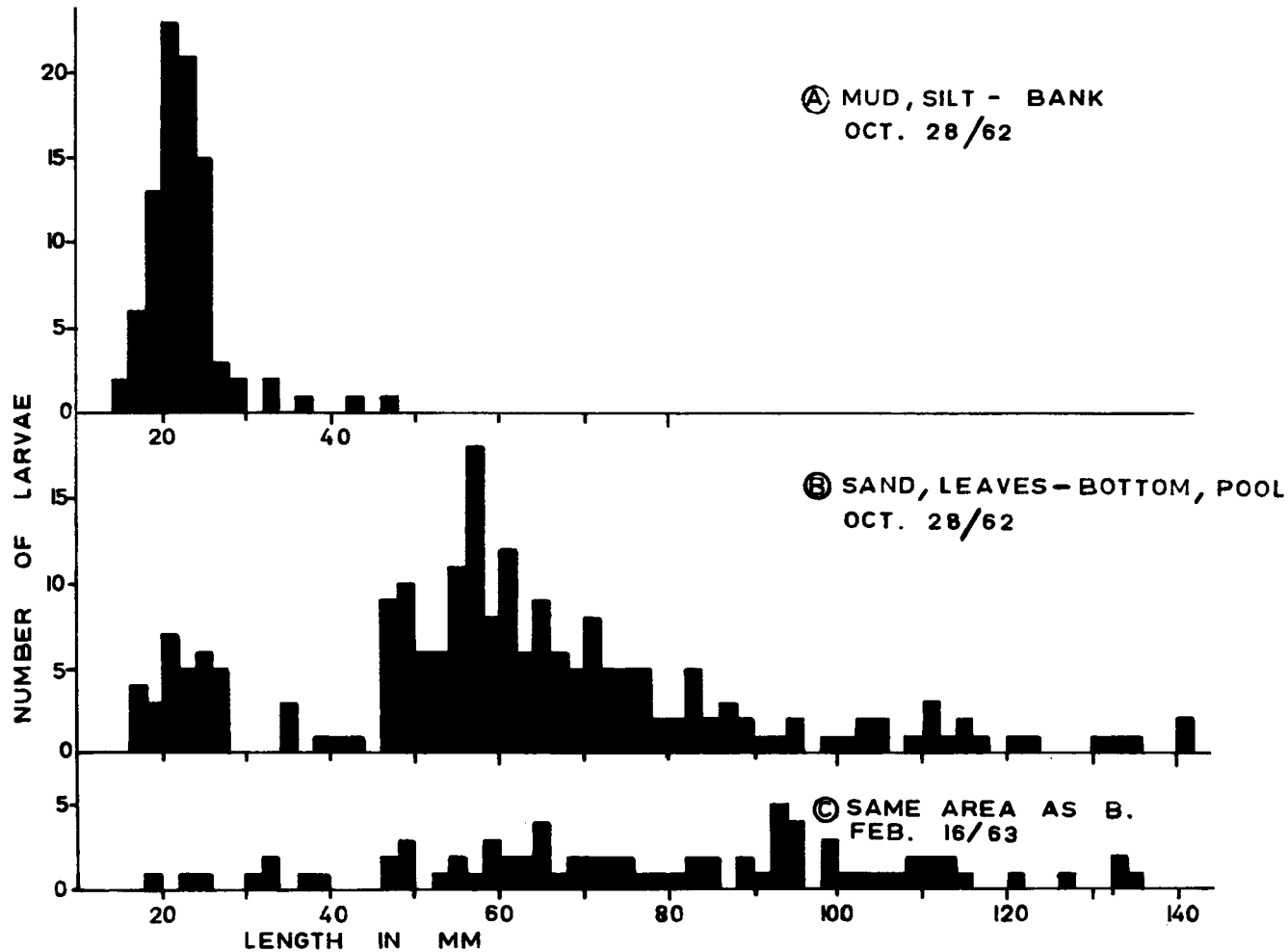


FIG.59. LENGTH-FREQUENCY DIAGRAMS OF LAMPETRA IN DIFFERENT HABITATS OF THE SALMON RIVER (STATION I).

from the substrate produced few larger ammocoetes (Schultz 1930). A combination of collecting methods seems necessary to collect all age classes.

10. Relative Abundance of Ammocoetes

An estimate of relative abundance of ammocoetes was obtained by counting the animals in a constant bottom area and quantity of sediment scooped from the ammocoete beds (Fig. 10). The greatest concentration of ammocoetes was found in the sand and leaf substrate of deep pools (Fig. 60 a, f, g). Mud areas did not contain as many ammocoetes as the sand and leaf areas. However, when a square root transformation was performed on the data and a t-test performed no significant difference was evident. Greater numbers of ammocoetes in the sand are probably due to the greater numbers of year classes present. Temporary winter ammocoete beds contained a significantly smaller concentration of animals than other beds. Flooding conditions on June 3 produced a great reduction in diversity, but pre-flood diversities were attained by June 10 when sediments had again accumulated when flow decreased.

Thomas (1963) found that sea lamprey ammocoetes were most abundant where the current was very slow and the bottom was very soft. He found that the population density of ammocoetes was proportional to bottom hardness and water velocity. In the absence of good bottom conditions, ammocoetes were able to find shelter in almost all naturally-occurring bottom materials. The Salmon River ammocoetes show the greatest concentrations in the harder sand and leaf bottoms of pools

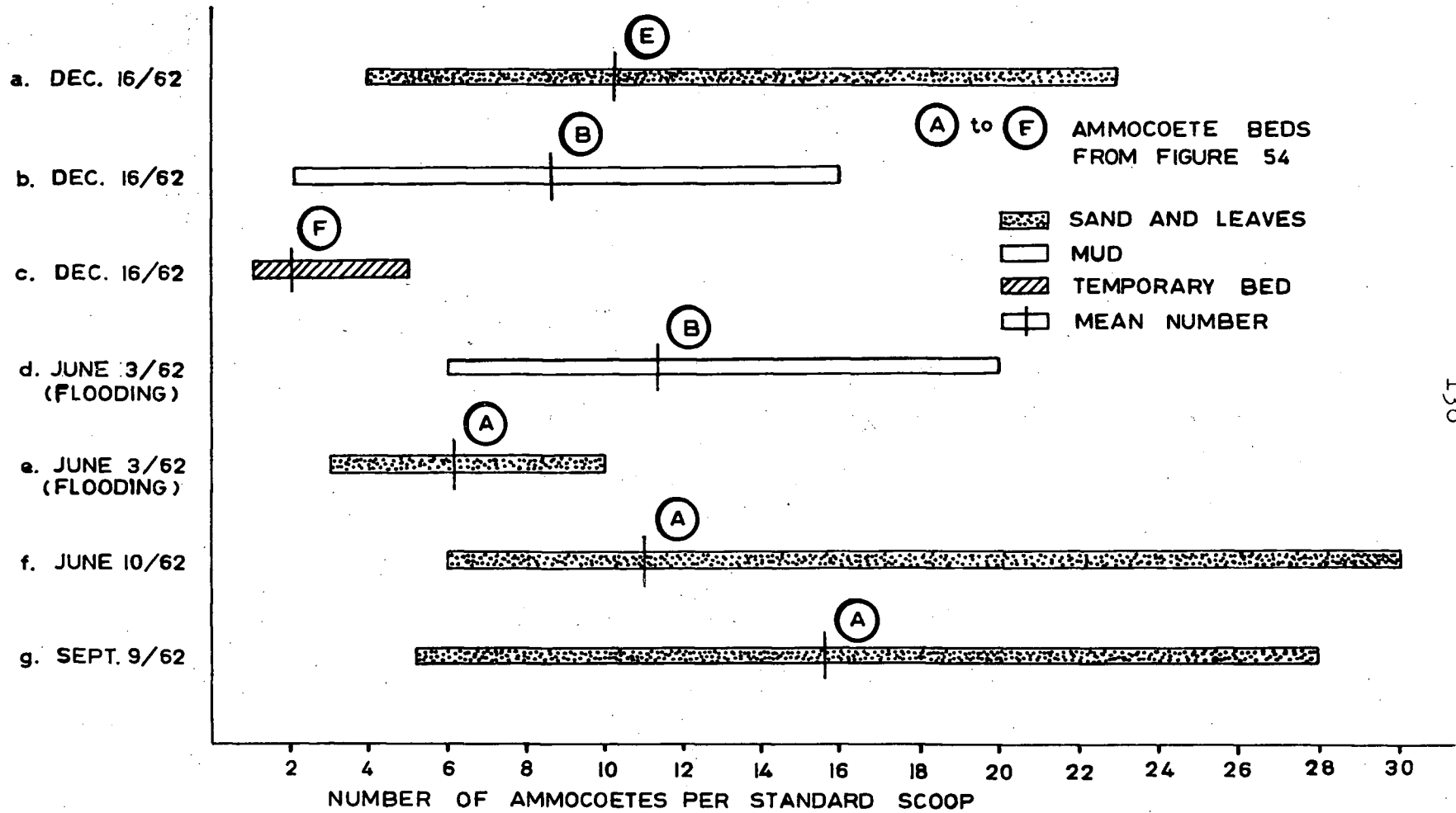


FIG. 60. CONCENTRATION OF AMMOCOETES FROM DIFFERENT BOTTOM HABITATS IN THE SALMON RIVER, STATION 1.

during the periods of reduced flow. The positions of the sand and leaf beds (Fig. 56A) near the central current of the stream would collect more ammocoetes than the beds at the side of the stream at low flow conditions. The smaller specimens would have difficulty penetrating the sand but the spaces between the leaves would enable the animals to enter the bottom. However, it appears that the smaller larvae are then washed from the sand beds or swim to settle permanently in the mud at the edge of the stream. The larger ammocoetes can remain in the sand beds permanently.

Winter collections of ammocoetes from the Salmon River at various depths showed the greatest concentration in the shallow water near the bank, but summer collections showed the opposite. Therefore, the ammocoetes seemed to collect near the shore in shallow water during the winter because increased current in deeper water erodes the beds and prevents penetration of the substrate whereas silt accumulation and reduced current occurs at the shore. In the summer the sand and silt beds (Fig. 55 and 56) in the deeper water (4 to 6 feet) contained the greatest concentration of ammocoetes. Thomas (1963) also found depth of little significance because water velocity determines silt deposition and position of ammocoete beds. Early workers usually recorded that ammocoetes preferred shallow water but this distribution was possibly due to silt deposition at the bank of streams due to a fall in current velocity rather than depth distribution.

11. Burrowing Behaviour of Ammocoetes

Knowledge of how ammocoetes burrow into a substrate offers some explanation of the substrate they select and their relative abundance in each substrate. Gage (1893) observed burrowing ammocoetes in glass containers and recorded two stages. First the animal stands vertically on its head and makes vigorous swimming movements while twisting the oral hood from side to side. These motions continue until the gill slits are buried. The second stage involves the buried section which parts the sand ahead of the larva with the stiff oral hood and pulls its body into the sand to form a U-shaped burrow. The Salmon River ammocoetes buried in the same manner as described by Gage.

The behaviour of an ammocoete liberated in an aquarium or stream was described by Reighard and Cummins (1916). The ammocoete " swims a short distance, then erects the body almost vertically, head downward, and burrows with rapid vibratory movement. It does not continue straight down, but turns horizontally, then upward, forming a burrow in the shape of a flattened U. The dorsal surface of the body is kept uppermost throughout this process." Salmon River ammocoetes observed in experimental troughs behaved similarly, but small ammocoetes had not completely buried their tails on many occasions until five minutes after they buried the pharynx.

Sawyer (1959) observed ammocoetes burrowing into a wad of cotton and found the oral hood was the main digging organ. The body was held rigid as the muscular movements pushed

the animal into the substrate. The oral hood was contracted to a point and moved from side to side to find the path of least resistance. When the head and pharyngeal basket were pushed forward as far as possible by the swimming and wiggling motion, the oral hood was flared out and served as an anchor as the body was pulled up from behind. The process was repeated until the ammocoetes were covered in the bottom and a U-shaped tube had formed with the head end open to the surface of the substrate. Sawyer's observations help to explain the difficulty for small ammocoetes from the Salmon River to penetrate hard bottoms as sand, but show a preference for mud and silt bottoms.

Applegate (1950) showed that the depth of the burrows was proportional to the larva's length with the largest larva (100-160 mm.) occupying a burrow 125 mm. in depth. Burrows in sand covered with muck were constructed entirely in the muck. This dislike for sand beneath softer bottoms restricted them to the surface layers in the Salmon River. Due to the depth of burrow construction the larger ammocoetes are likely to be unaffected by flooding while the smaller specimens are likely to be carried downstream by the current, which is what occurred in the Salmon River (Figures 57, 59, and 60).

The absence of small ammocoetes from sand beds in the Salmon River may be due to their difficulty to force the sharp sand grains apart and their lack of sufficient swimming speed to maintain a position in current. However, sand interspaced with leaves or containing a top layer of mud offered

refuge from the current.

Ammocoetes from the Salmon River seem to need contact with the bottom or to have their bodies touching a substrate. Harden-Jones (1955) showed a thigmotaxic response of L. planeri ammocoetes in the laboratory. A photokinesis response (Young 1931) also helps to keep them buried in the mud of stream bottoms. As the animals increase in age, their preference for bottom contact and darkness decreases. Leach (1940) found that transforming brook lamprey gradually lost their preference for the bottom.

12. Movement of Ammocoetes in Burrows

The bottom of a 5-gallon aquarium was filled with 3 inches of mud from an ammocoete pool of the Salmon River on September 28, 1962. Twenty ammocoetes (15-50 mm.) were introduced into the mud. The bottom of the tank was marked off into 16 equal parts by a grid fitted over the top of the tank so that the exact position of each lamprey burrow could be recorded. Morning and evening observations were taken from October 3 to 5 and daily observations were made from November 6 to December 31. One of the sections was randomly chosen as a control square and contained no lampreys. This square was partitioned off with nylon cloth so that worm and insect burrows could be differentiated from those of ammocoetes.

Over a 24-hour period never more than 20% of the burrows remained unchanged. All burrows had shifted position over a 48-hour period. New burrows were formed during the day and night. No ammocoetes were seen outside their burrows at

any time. Thomas (1963) observed similar results for the sea lamprey, but he found no evidence of circadian rhythm of burrow construction or leaving the burrow during the dark. He took photographs of the ammocoete burrow mouths but found no individuals visible during the darkness. He found a circadian rhythm of free-swimming activity present in the ammocoetes during the dark. Therefore a large proportion of the population apparently leave their burrows during the dark but this was not recorded by the film.

Thomas (1963) collected ammocoetes in weirs at dawn and dusk and showed that migration occurs almost exclusively downstream and at night. He correlated this migration directly with water temperature and water flow. Migration of ammocoetes would account for the shift of age composition and concentration within the ammocoete beds of the Salmon River. A spawning migration of adult lamprey from the region below station 1 to above station 1 is suspected because the ammocoetes moving to new burrows are displaced downstream, but they must return to gravel areas to spawn in the spring.

13. Growth of Ammocoetes

The lamprey of British Columbia and Washington are characterized by a particularly long spawning period (April to July). This makes determination of age by identification of year classes from length-frequency data very difficult. The modes of the fast growing individuals tend to overlap those of the slow growing animals.

The modes of the first two age groups from the

Salmon River (young of the year and one year larvae) can be easily distinguished in most collections (Figures 61 and 62). The yearly growth for the first two year classes was plotted from the position of the modes at various times throughout the year and two curves were fitted by eye (Fig. 63). These growth curves reveal a period of slowing down or cessation of growth during the winter months. This was also suspected by Schultz (1930) for L. planeri in Washington State. The young of the year in the Salmon River grow rapidly from June to November while the first year larvae grow most rapidly from April to August. Intestine analysis of larger ammocoetes reveals that the main food supply (diatoms) is rather scarce in the winter months, abundant in the spring and summer, and rather scarce in the late fall. The period of greatest growth by the ammocoetes is most likely dependent upon density of diatoms in the stream.

A comparison of the growth of positions of modes in the Salmon River (Fig. 62) with that of other river systems (Fig. 61) reveals a great similarity of modes for the first year classes. This suggests that most Lower Fraser Valley streams and Vancouver Island streams produce ammocoetes that have the same growth rates. The preference for bottom type as in the Salmon River was observed in the streams in Fig. 61. Smaller year classes were found in the mud and sand bottoms while the larger ammocoetes occupied the variable bottom of sand, leaves, and mud in the pool areas.

The histograms of the Salmon River ammocoete collections (Fig. 62) show a great variability in the year class

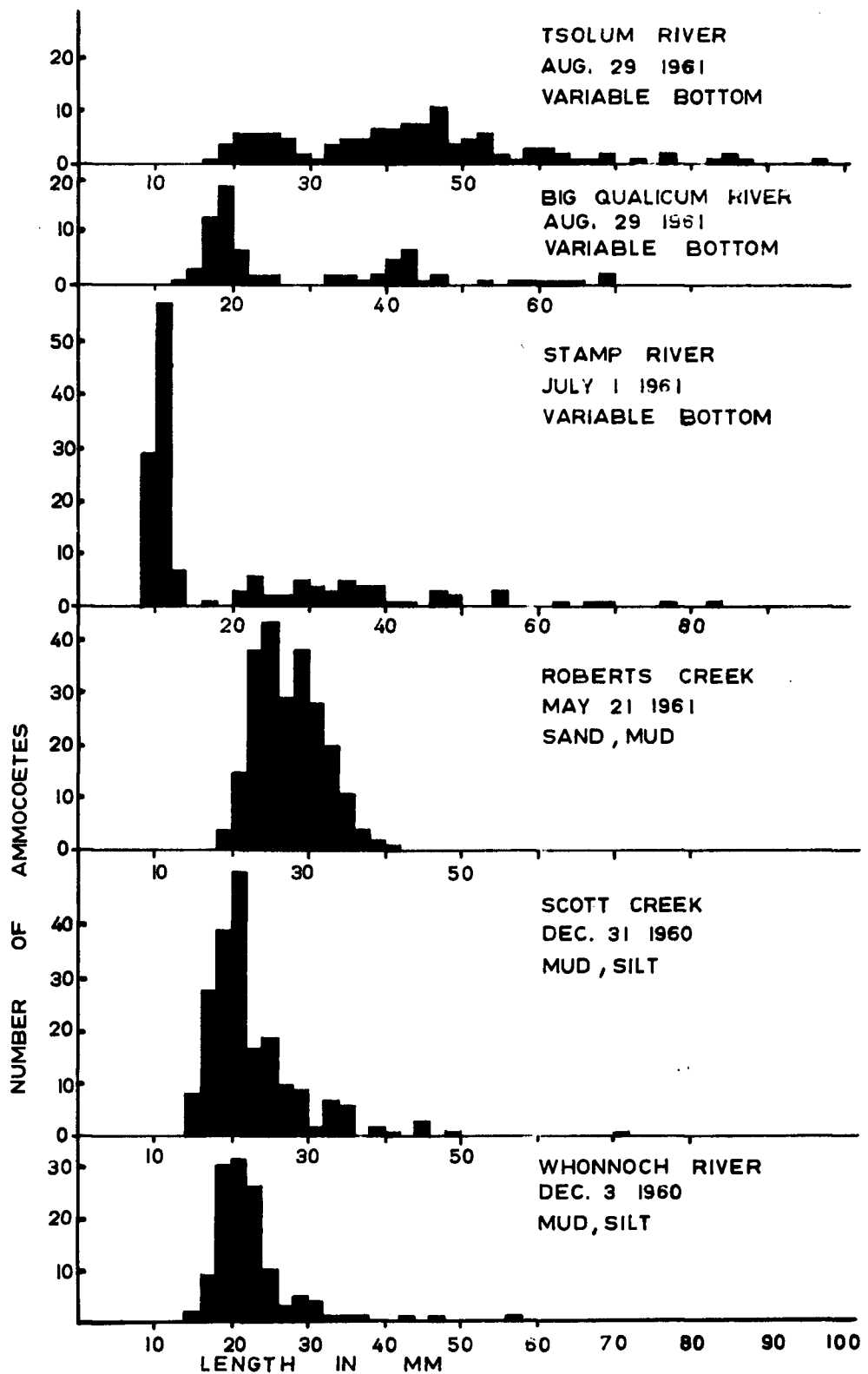


FIG. 61 LENGTH-FREQUENCY DISTRIBUTION OF AMMOCOETES FROM CERTAIN STREAMS IN BRITISH COLUMBIA.

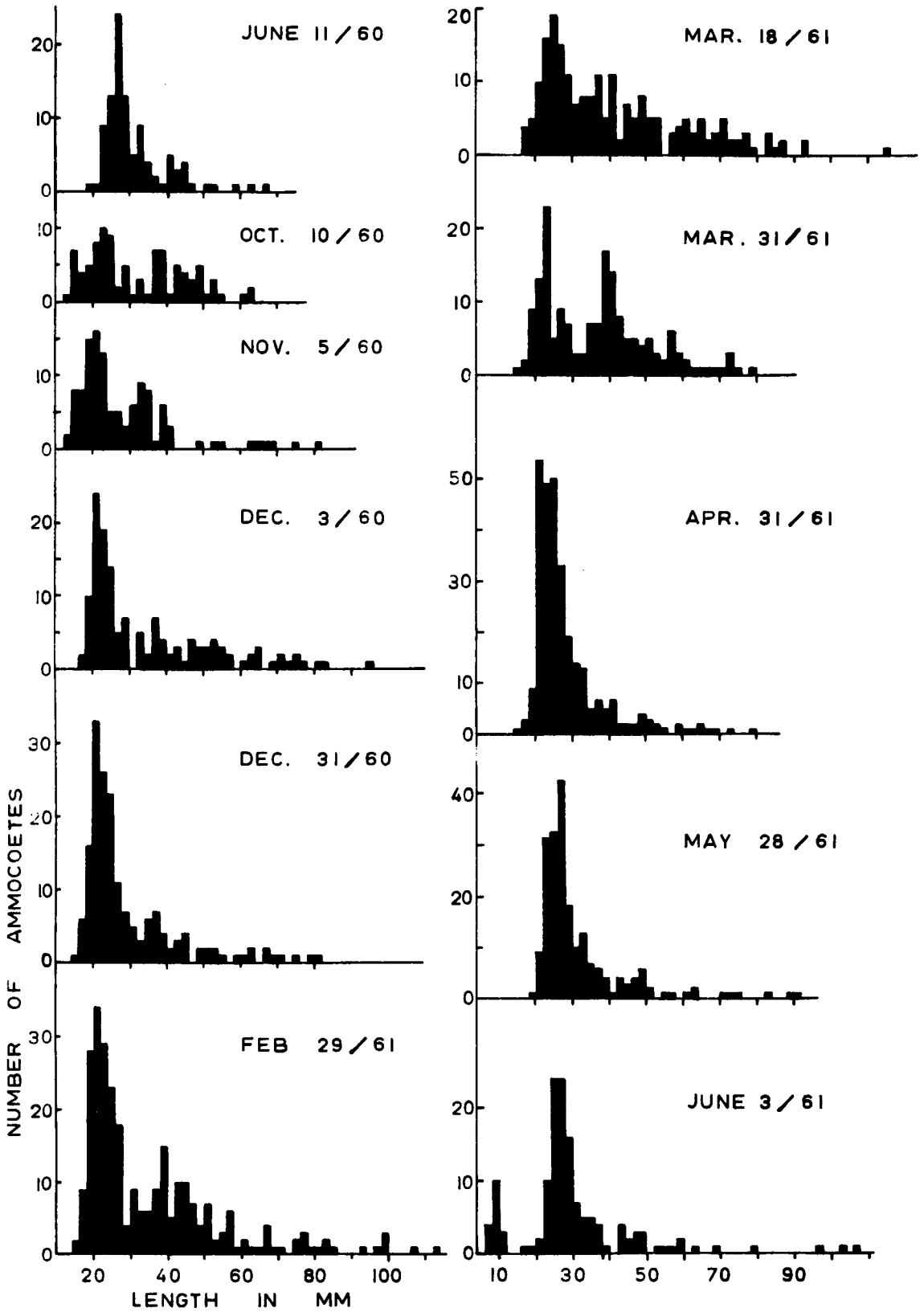
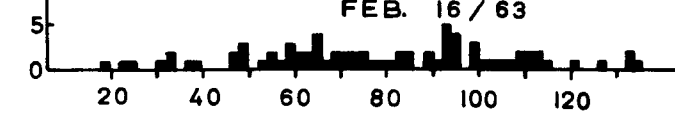
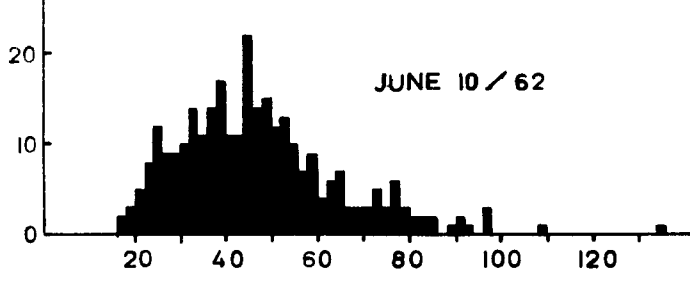
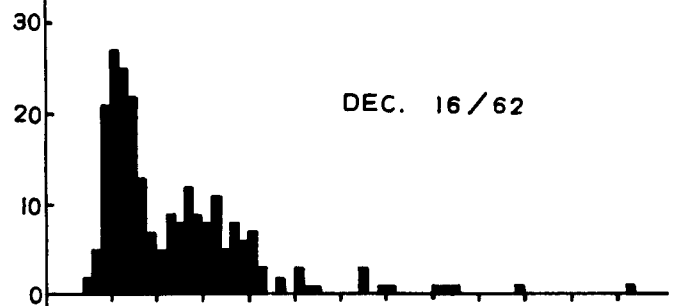
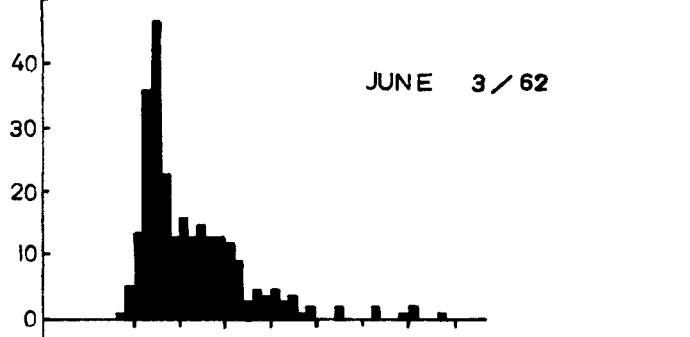
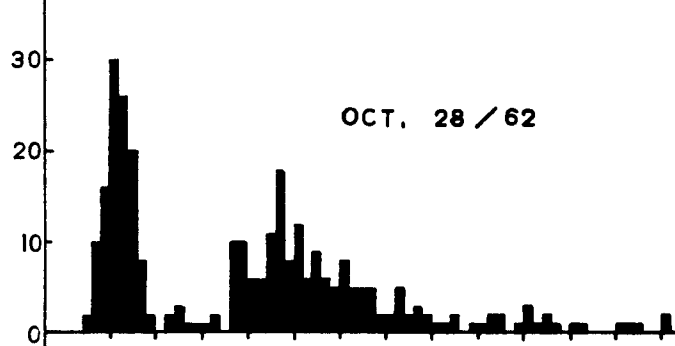
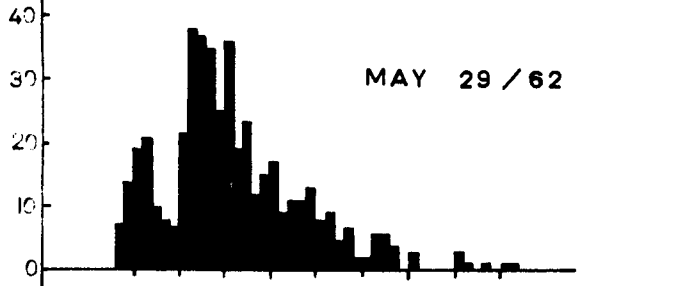
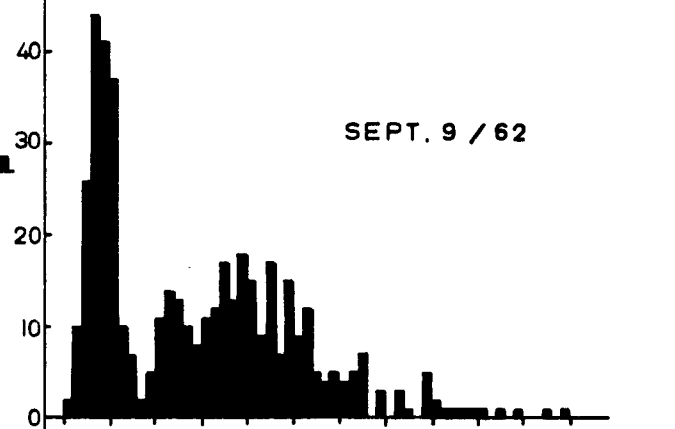
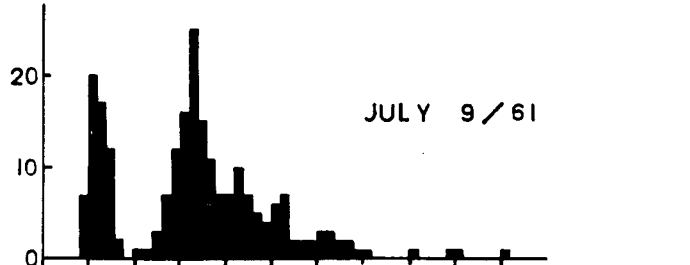
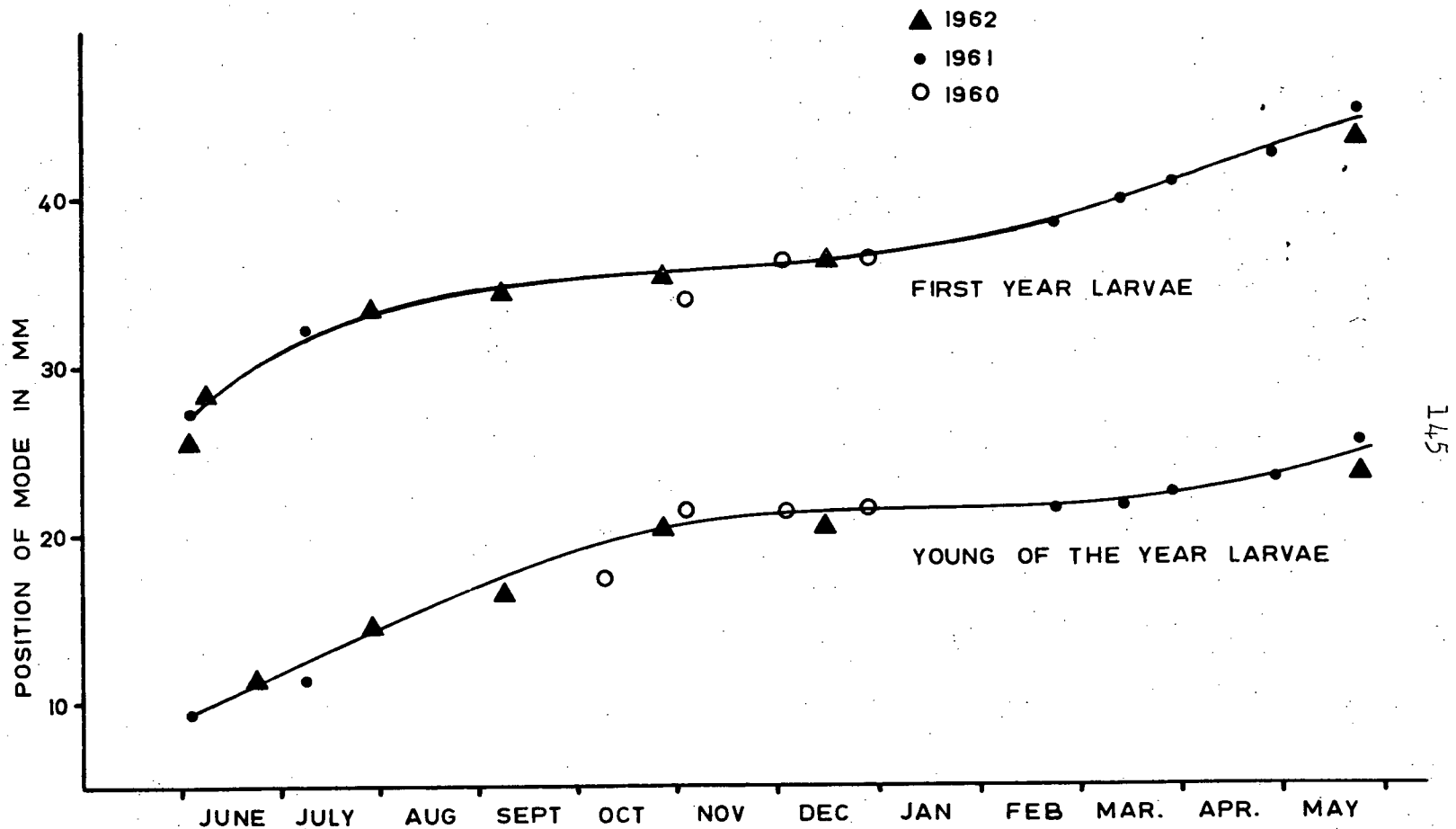


Fig. 62 Length-frequency distribution of ammocoetes from the Salmon River, 1960-1963.





145

FIG. 63. GROWTH OF AMMOCOETES (*L. planeri*) IN THE SALMON RIVER DURING THE YEAR 1960-62 (curve fitted by eye)

as collected at different times of the year and in different habitats. Sampling a variety of habitats produced a variety of year classes and represented the population, but samples of a restricted area usually revealed only one or two year classes.

14. E. tridentatus Ammocoetes from the Thompson and Nicola River

Collections of E. tridentatus larvae were taken from this river system on three occasions for comparison with the mixed population (Lampetra and Entosphenus) from the Salmon River. The August 19, 1961 collection was taken from three different habitats and locations on the river system to compare with similar habitats in the Salmon River.

In the Nicola and Thompson Rivers the stream bed is characterized by riffle and pool areas. The riffle areas contain large boulders and larger gravel size than that present in the Salmon River. The pool areas of the Nicola and Thompson Rivers do not contain the quantity of silt and plant debris that is common in the Salmon River. The water discharge and drainage basin is much larger for the Thompson and Nicola system. The cold winter conditions may reduce or decrease growth for the ammocoetes in the interior rivers.

The histograms in Fig. 64 show that the Entosphenus larvae seem to exhibit similar preference for bottom type as the Salmon River population. The smaller larvae (Camford Station) were collected in a predominantly mud bottom while the larger ammocoetes were collected in the sand and leaves of pools (Dot station) of the Nicola River and Spenser's Bridge

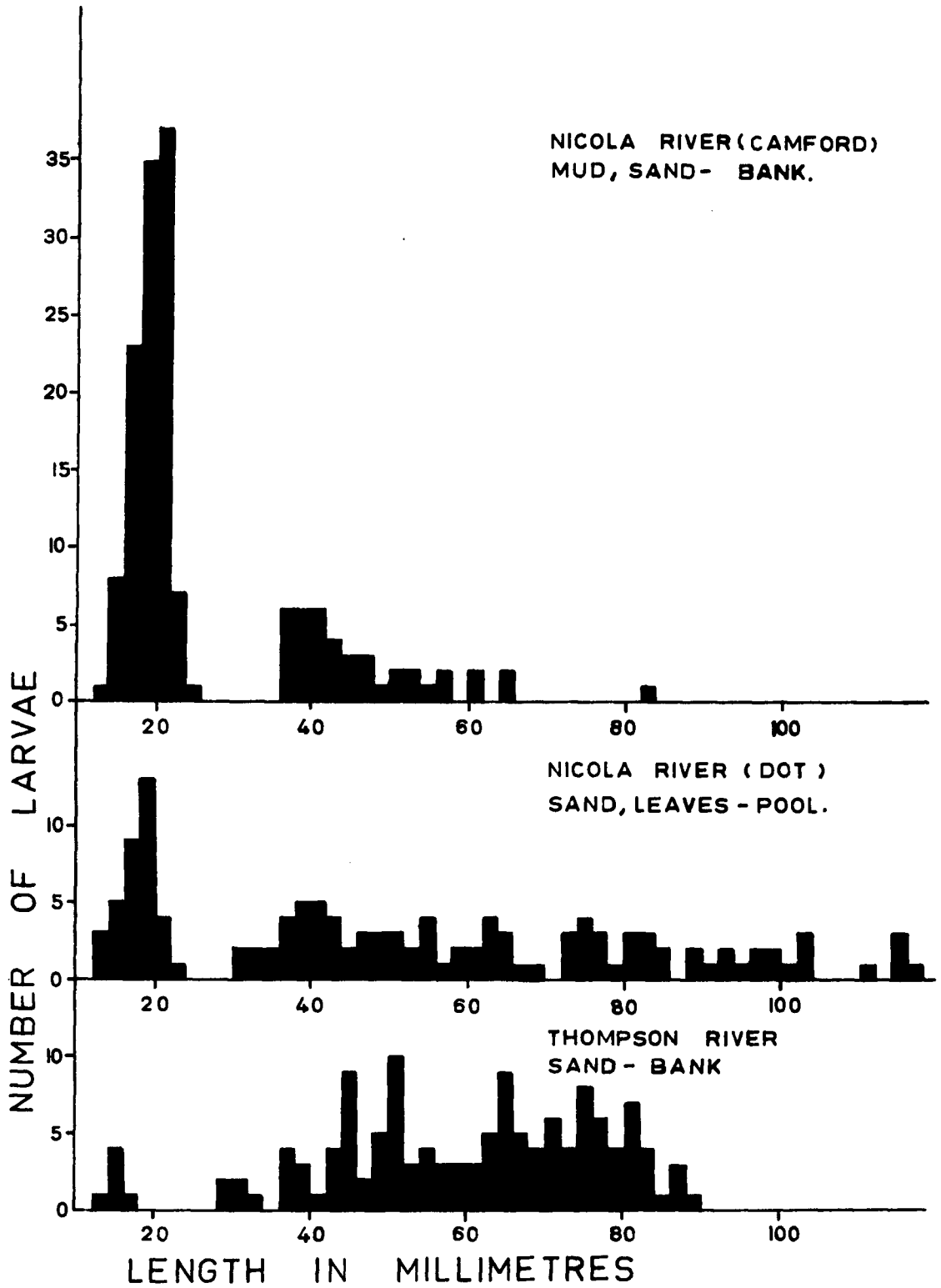


FIG.64. LENGTH-FREQUENCY DIAGRAM OF ENTOSPHEBUS LARVAE, AUG. 19/61

on the Thompson River. Figure 64 indicates an increase in the number of smaller larvae as the collections were taken farther up the Nicola River. This could indicate a spawning above Merritt and a migration downstream by the larvae. However, later collections indicate large ammocoetes in the upper river as well. Thus habitat selection by the ammocoetes and sampling variation, as well as some downstream migration would be possible explanations for this distribution. The length-frequency histograms (Fig. 65) show the data collected and means for each age class can be followed throughout the collections.

L. planeri and E. tridentatus exhibit similar larval requirements and general stream behaviour. E. tridentatus possess a faster growth rate and a possible shorter larval period than L. planeri. The intestines of 10 ammocoetes from the Nicola River in April and August revealed a greater abundance of diatoms than the Salmon River population. Cymbella was a diatom that was particularly dominant in most intestines. The increased diatom intake by the ammocoetes may account for the faster growth rate of Entosphenus in the Thompson and Nicola Rivers than the mixed population (predominantly Lampetra) of the Salmon River.

15. Age Determination and Growth Curves of Ammocoetes

The separation of the year classes was determined using the probability paper graphic method of polymodal frequency analysis devised by Harding (1949) and extended by Cassie (1954). Two of the largest collections of L. planeri

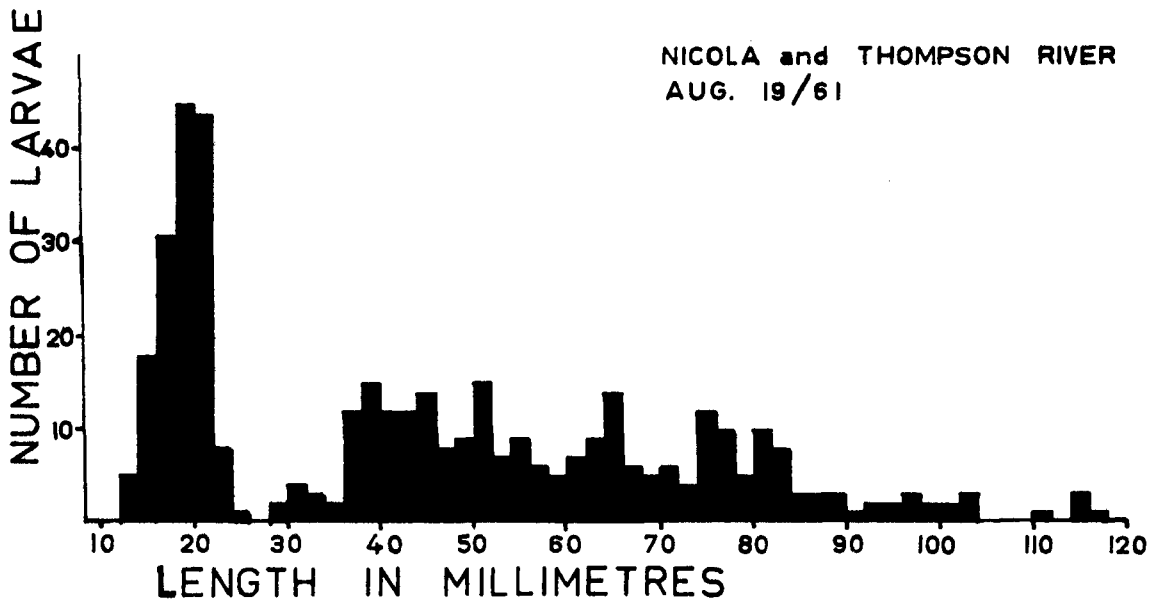
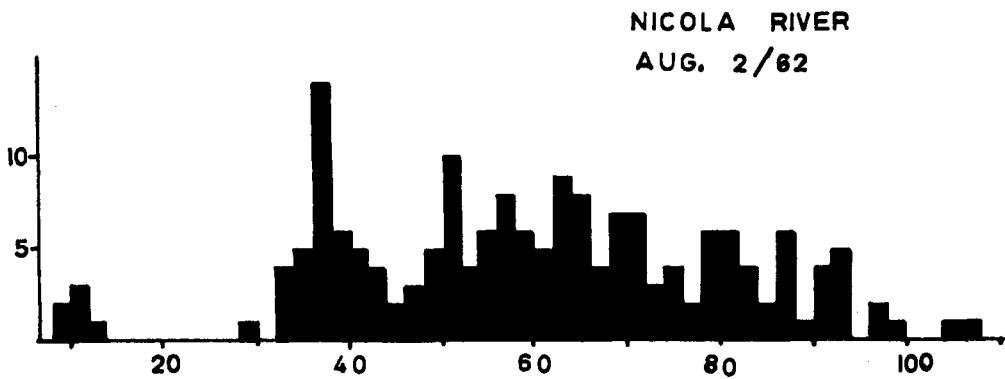
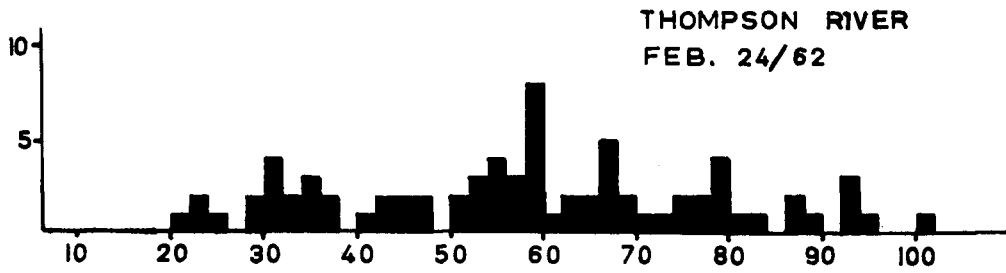


FIG.65. LENGTH-FREQUENCY OF ENTOSPHEMUS LARVAE FROM THE NICOLA and THOMPSON R.

(10 percent E. tridentatus) from the Salmon River (Fig. 66 and 67) containing the greatest number of year classes were selected for the probability paper analysis. The two large collections of E. tridentatus from the Nicola and Thompson Rivers (Fig. 68 and 69) were used to separate the year classes. A summary of the probability paper analysis is presented in Table 9 which shows the mean, percent of the collection, and standard deviation for each age class. The two collections of each species when plotted offered a check for picking the correct inflection points.

The growth curve for each species was drawn by eye from the mean of each age class (Fig. 70 and 71) and the curves of the two species are presented in Fig. 72. The inflection points were difficult to pick out in Fig. 69 as two minor nodes could be accepted instead of a single age 3 node. If the age 3 minor nodes were plotted as in Fig. 71 then the growth curve would not correspond to the curve of the other sample (Fig. 68). The major age three node places the curve in agreement with the other sample of E. tridentatus. The inflection points for both L. planeri samples showed good agreement when the growth curve was fitted.

A comparison of the growth of L. planeri and E. tridentatus shows both curves to be very similar. A slightly more rapid rate of growth occurred in E. tridentatus ammocoetes. This could be due to differences in nutrition. E. tridentatus appears to decrease growth in the older larvae stages as indicated by the growth curve, but this is possibly due to

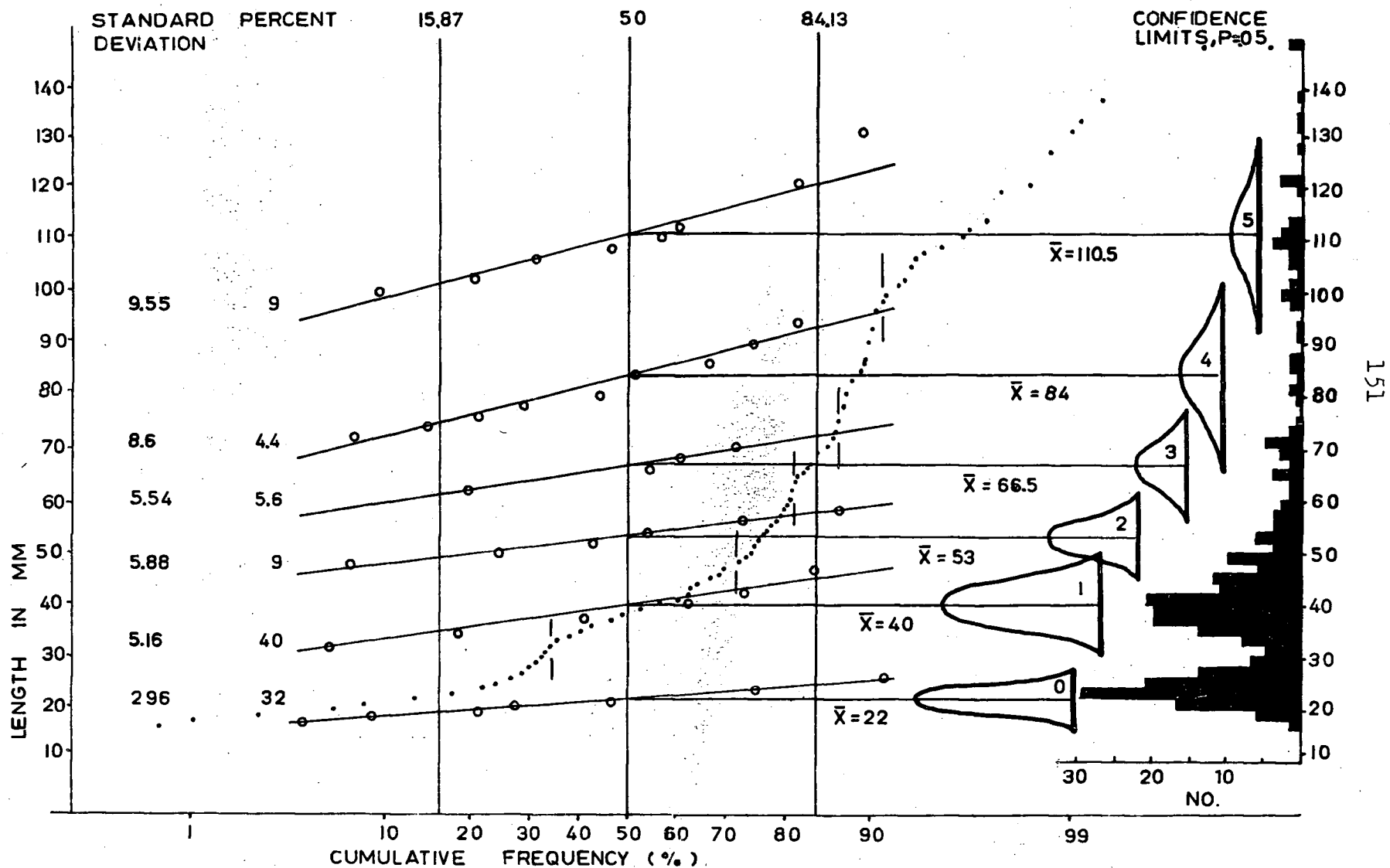


FIG. 67. SEPARATION OF POLYMODAL FREQUENCY DISTRIBUTIONS OF L. PLANERI AMMOCOETES USING PROBABILITY PAPER (SALMON RIVER, FEB. 23, 1962)

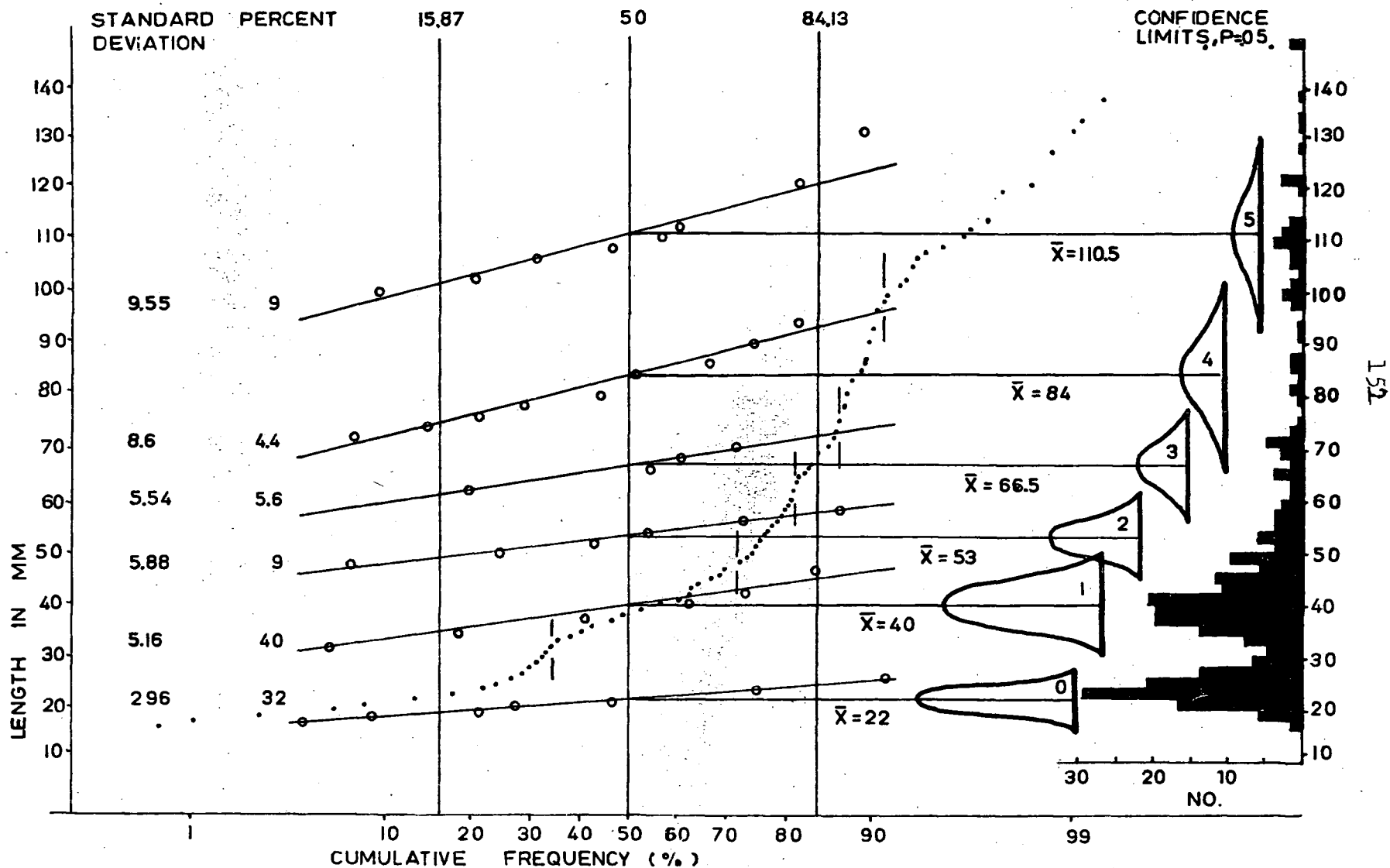


FIG. 67. SEPARATION OF POLYMODAL FREQUENCY DISTRIBUTIONS OF L. PLANERI AMMOCOETES USING PROBABILITY PAPER (SALMON RIVER, FEB. 23, 1962)

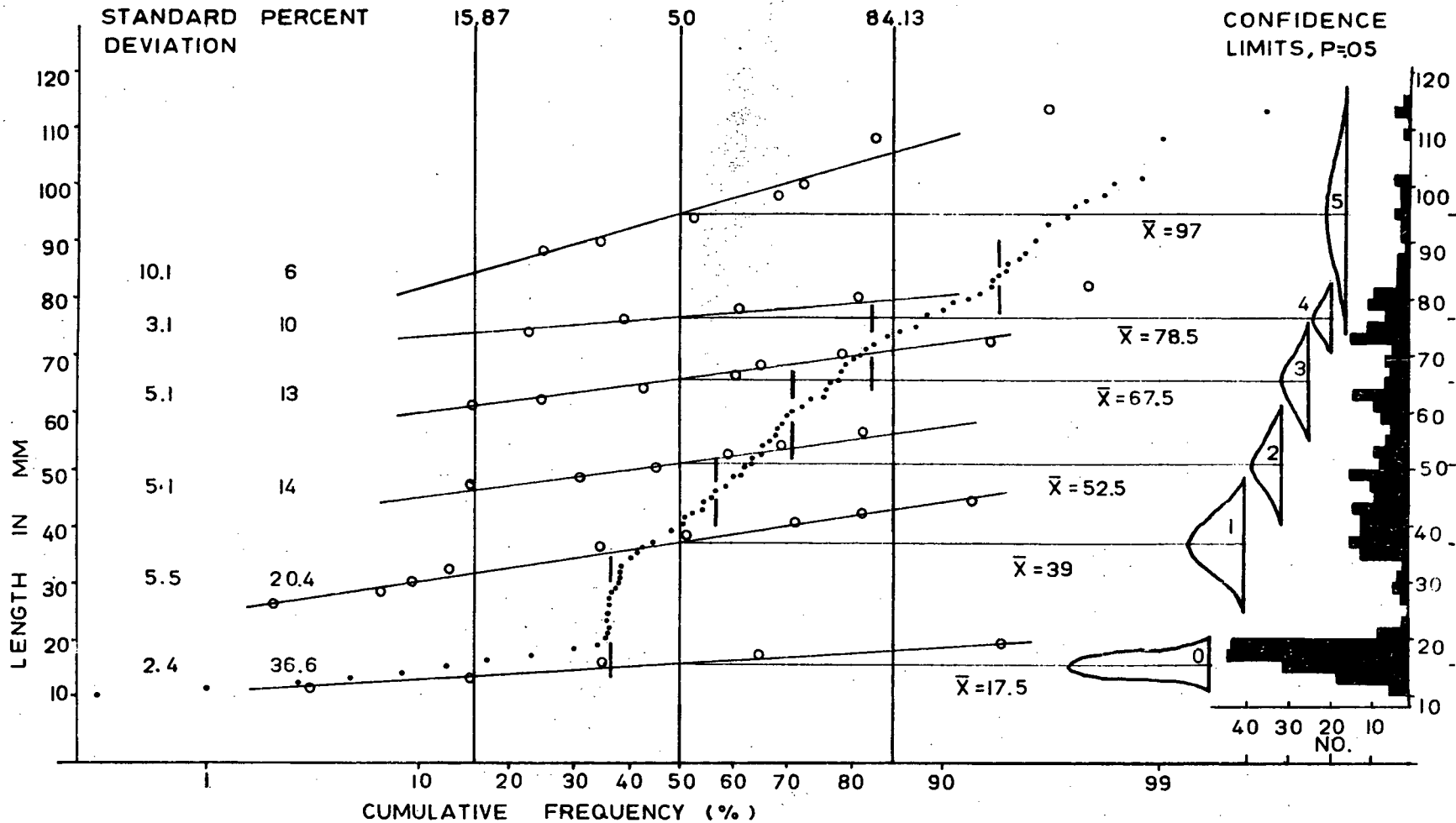


FIG. 68. SEPARATION OF POLYMODAL FREQUENCY DISTRIBUTIONS OF E. TRIDENTATUS AMMOCOETES USING PROBABILITY PAPER (THOMPSON AND NICOLA RIVER, AUG. 19, 1961)

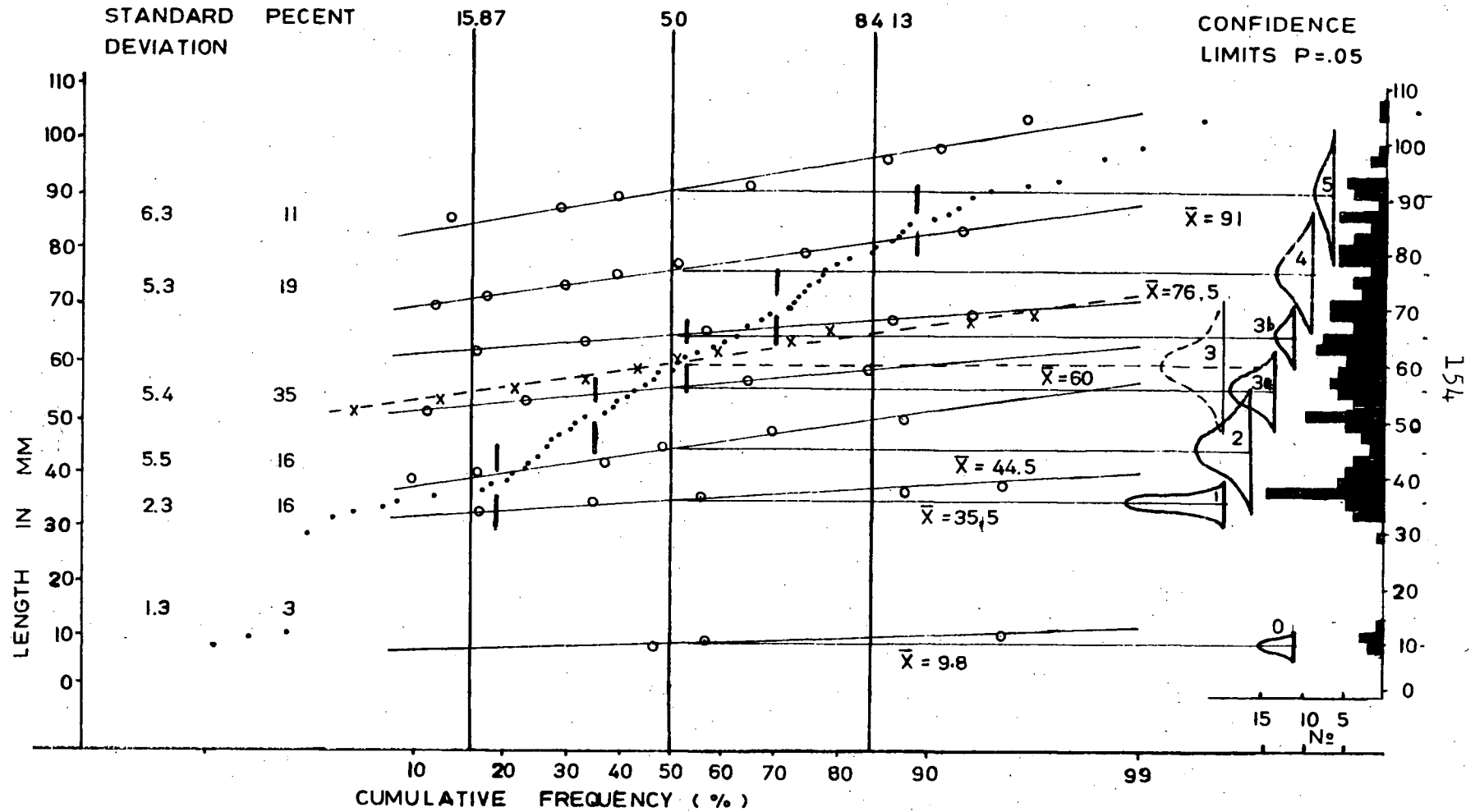


FIG. 69. SEPARATION OF POLYMODAL FREQUENCY DISTRIBUTIONS OF E. TRIDENTATUS AMMOCOETES USING PROBABILITY PAPER (NICOLA RIVER, AUG. 2, 1962)

Table 9 Summary of probability paper analysis of two collections of L. planeri and E. tridentatus.

L. planeri

<u>Date</u>	<u>Age</u>	<u>Percent</u>	<u>Mean</u>	<u>Standard Deviation</u>
Sept. 9/62	0	39	17.5	2.4
	1	20	36	4.17
	2	17	47.5	3.76
	3	14	58	3.6
	4	6	72.5	4.14
	5	5	95.5	9.92
Feb. 23/62	0	32	22	2.96
	1	40	40	5.16
	2	9	53	5.88
	3	5.6	66.5	5.54
	4	4.4	84	8.6
	5	9	110.5	9.55

E. tridentatusDate

Aug. 2/62	0	3	9.8	1.29
	1	16	35.5	2.31
	2	16	44.5	5.5
	3a	18	55.5	3.6
	3	35	60	5.4
	3b	17	65	2.85
	4	19	76.5	5.27
	5	11	91	6.3
	Aug. 19/61	0	36.6	17.5
1		20.4	39	5.5
2		14	52.5	5.1
3		13	67.5	5.1
4		10	78.5	3.1
5		6	97	10.1

• FEB. 23, 1962.

X SEPT. 9, 1962.

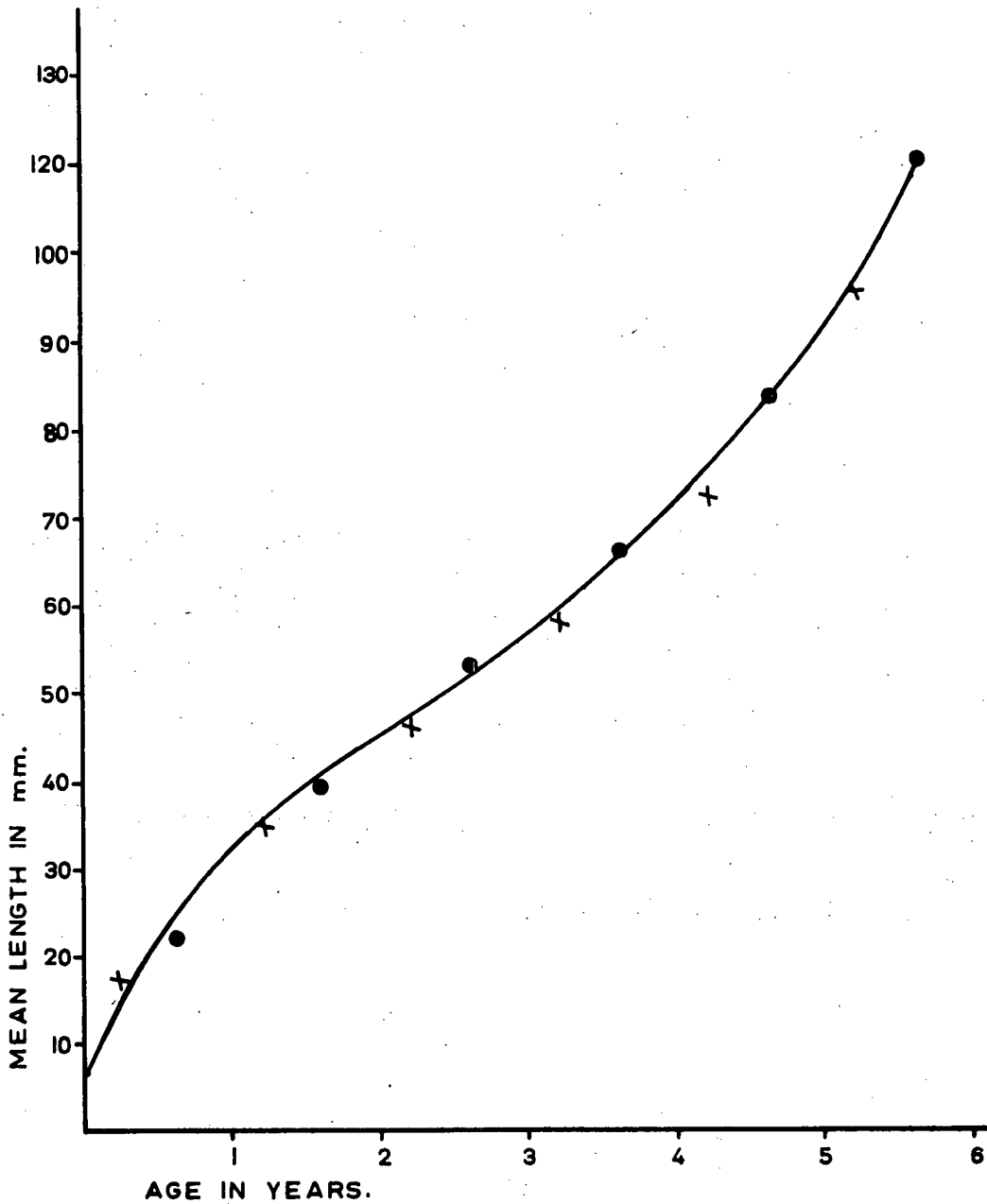


FIG.70. GROWTH CURVE OF LAMPETRA PLANERI FROM THE SALMON RIVER

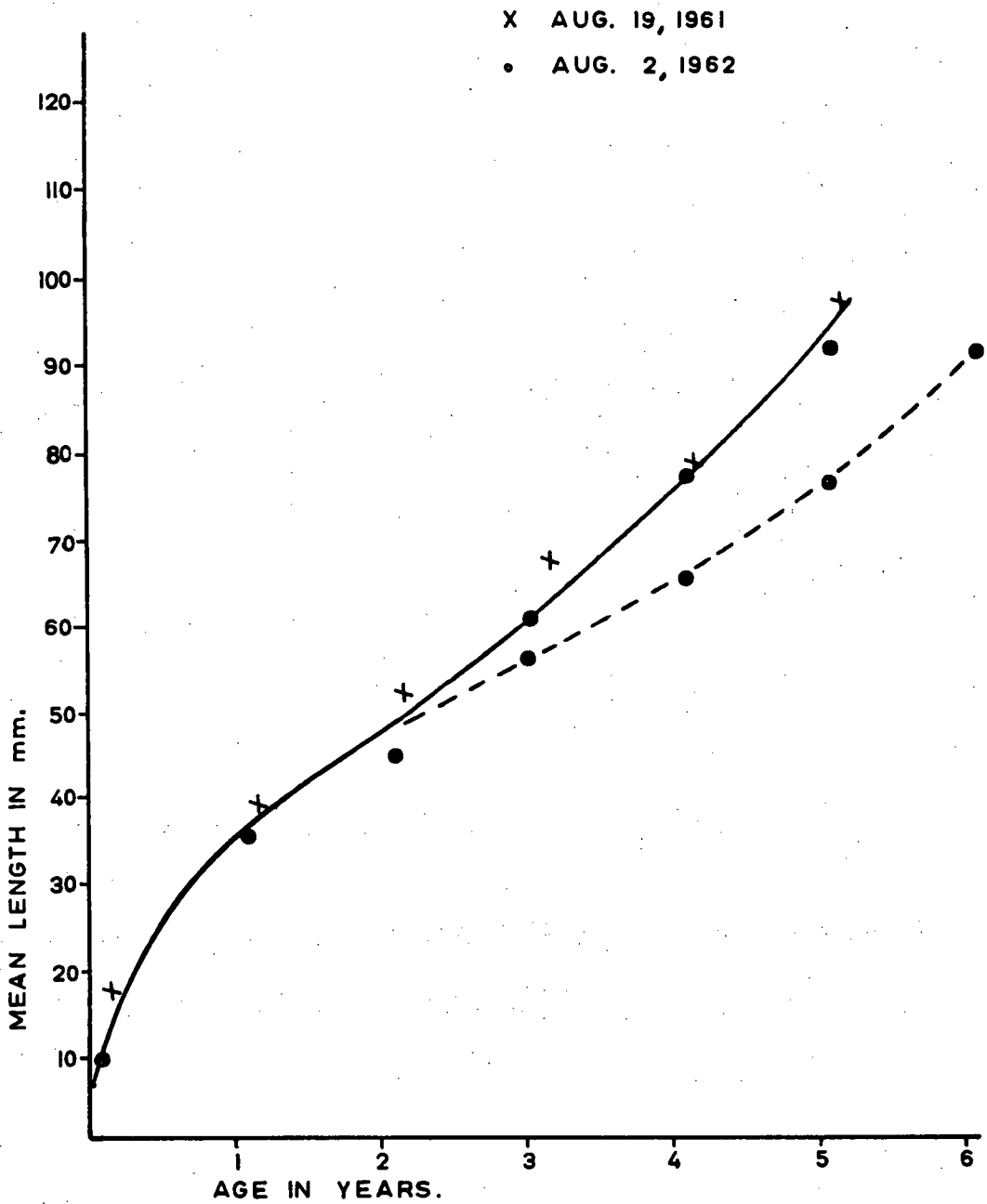


FIG. 71. GROWTH CURVE OF ENTOSPHEBUS TRIDENTATUS NICOLA AND THOMPSON RIVER

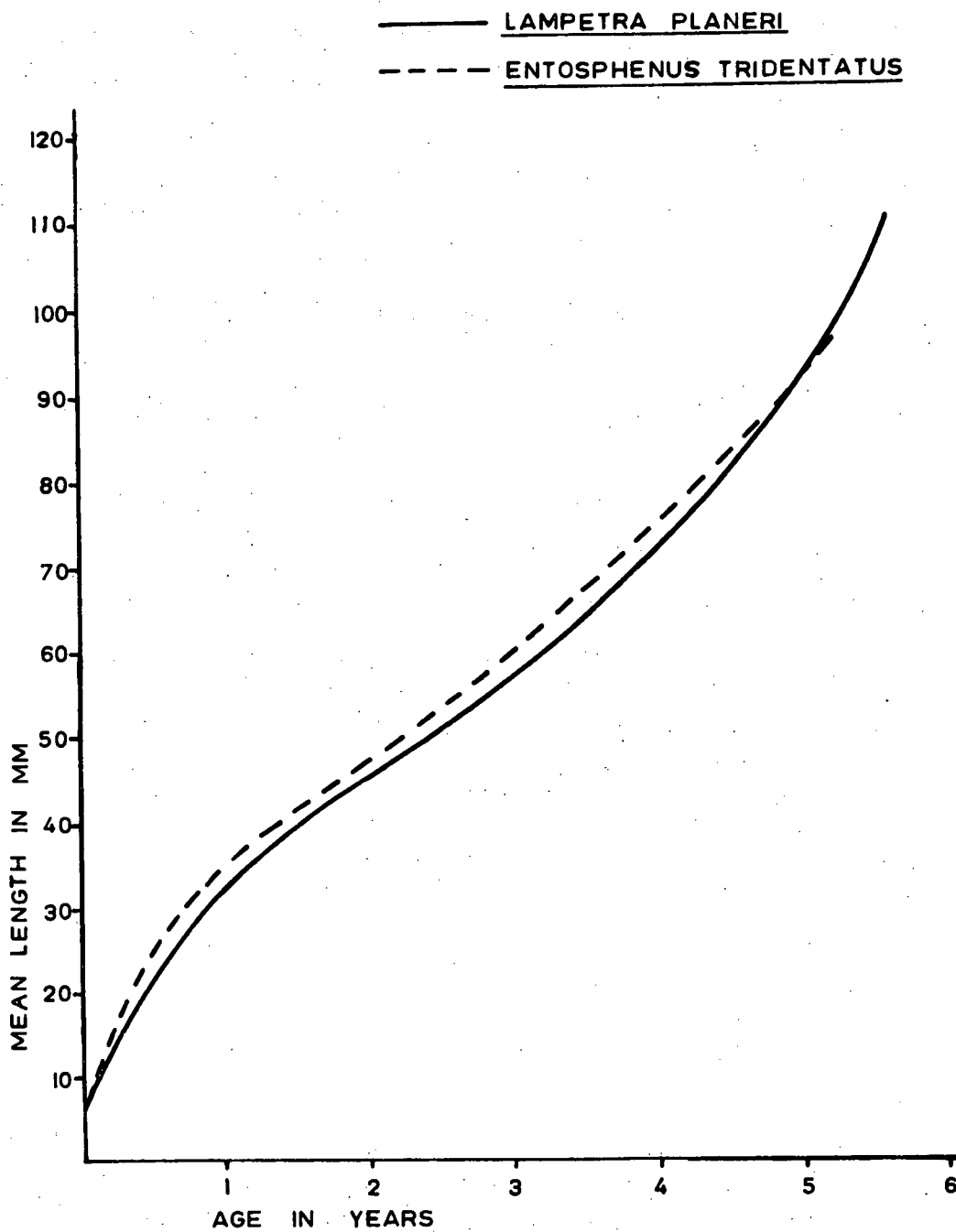


FIG.72. GROWTH CURVES OF BRITISH COLUMBIA LAMPREYS (NICOLA AND SALMON RIVER)

difficulties in aging the older larvae. The 10 percent of E. tridentatus mixed with the L. planeri population of the Salmon River would seem to have little or no effect on the analysis of growth and age determination because of the similarity of growth between the two species.

The average life cycle of L. planeri appears to be 6 years or more and that of E. tridentatus is 7 years or more. No allowance was made for possible reduction in length before transformation, for premature individuals, or for the presence of a rest period. Schultz (1930) in Washington State and Knowles (1941) in England ascertained the larval life of L. planeri to be three years. Zanandrea (1951 and 1954) and MacDonald (1959) calculated the larval life to be four and one-half years for the same species in Europe. Hardisty (1961) estimated the average larval period of L. planeri in England at about five and one-half years from large samples collected throughout each year from 1940 to 1960 in one river system. He determined that ammocoetes grow more rapidly during the first year and in the final growth season before transformation, but at transformation he found a reduction in length. He estimated that the annual mortality rate of ammocoetes was fairly uniform throughout the larval period. The growth curve of British Columbia lampreys agrees with the shape of Hardisty's lamprey curves but both do not represent the actual growth because of lack of knowledge of the biology of the last few years of larval life.

The percentage of each year class present in each

collection is not constant in the two samples analysed for each species (Table 9). The means of the year classes show a very good fit for the growth curve (Fig. 70 and 71). The standard deviation for the first to third age classes show remarkable consistency but variations increased with the larger age classes. This is possibly due to a rest period, sexual differences in growth, or individual differences in growth.

The growth curves of the ammocoetes for the two species of lampreys (Fig. 72) are representative of ammocoete growth up to ages 3 or 4, but then the curve becomes inconsistent with the biology of the larger larvae. The accumulated variables of individual growth, length differences with sex, possible reduction in length before transformation and the presence of a rest period all tend to make length frequency analysis inadequate for the larger sized larvae. Growing marked ammocoetes in a stream environment from age two or three would be desirable.

If local ammocoetes possess a rest period, then the growth curve up to transformation would take on the shape of the von Bertalanffy growth curve for length.

$$L_t = L_{\infty} \left(1 - e^{-k(t-t_0)} \right)$$

L = asymptote of the growth curve

t_0 = age at length zero, if the animal had grown

according to the formula over the whole of its life.

k = slope

t = age

A line of best fit could be calculated for the British Columbia lamprey growth (as used by Thomas 1963) but this would only be an approximation and crude representation of actual ammocoete growth. Hardisty (1961), Okkelberg (1922), and Hubbs (1924) presented growth curves for lampreys up to transformation that are similar to those of British Columbian lampreys. Hubbs (1924) presented a lamprey growth curve that rises to an apex at metamorphosis and then decreases at the onset of sexual maturity.

British Columbia ammocoetes grow mainly during the spring and summer so the curves shown really are composed of a number of steps of growth as shown in Fig. 63. Ammocoetes grow rapidly during the first year of life, then decrease growth over the winter, but increase growth again in the spring. Complications of biology just before transformation prevent a more detailed mathematical representation of the growth curves.

16. Transformation or Metamorphosis of Ammocoetes

L. planeri

A few transforming individuals were collected during September and October in the Salmon River and during August in the Tsolum River. Ammocoetes larger than 90 mm., transforming ammocoetes, and adults are compared in the length-frequency diagrams in Fig. 72. A reduction of ammocoete size at transformation could conceivably take place in the Salmon River population because the largest ammocoetes are larger than the transforming ammocoetes and there is little difference in the range in size between the three groups of Lampetra. In the

Tsolum River collection one transforming larva was larger than any of the ammocoetes but it is difficult to draw any conclusions about reduction in size from this observation.

Most workers who have examined transforming larvae have reported that ammocoetes decreased in length at the onset of metamorphosis (Meek 1916, Hubbs 1924, MacDonald 1959, Zanandrea 1951, 1954, 1957, 1961, Hardisty 1961, Knowles 1941, and Leach 1940). Leach (1940) has found by growing ammocoetes that they reduce their length by 10 percent at metamorphosis. He maintains that ammocoetes may spend an entire year in the full grown condition or "rest period" before onset of the transformation period. He found that one-third of the ammocoetes within the limits of transformation size transform within a year. Gage (1927) suspected a rest period existed in the sea lamprey. A rest period could conceivably exist in the Lampetra population in British Columbia because there is little difference in the size range from the largest ammocoete to the adults. Thus growth could stop, or the ammocoetes could decrease in length, before transformation.

Leach (1940) divided the transformation period into three sub-divisions: a rest period which precedes metamorphosis and extends for one year, the latter part being a non-feeding stage; an early transformation period of two or three months which in British Columbia Lampetra probably extends from August to November; an immature adult period ends transformation and extends from November to March or earlier for Lampetra. Leach reported that the intestine of the early ammocoete stage was

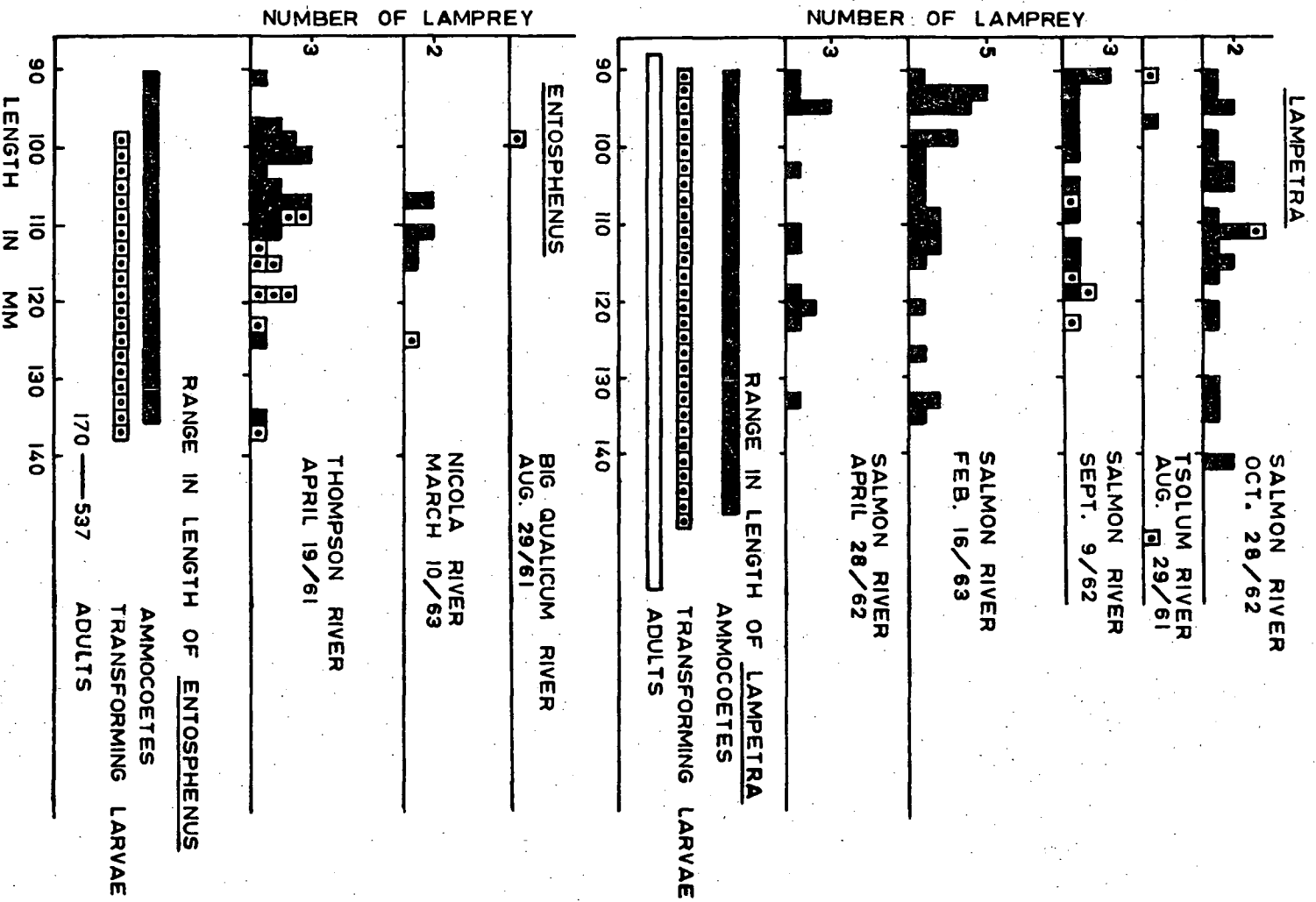


FIG. 73. LENGTH-FREQUENCY DIAGRAMS OF TRANSFORMING LARVAE, AMMOCOETES AND ADULTS OF LAMPETRA AND ENTOSPHEENUS.

empty and reduced in size from that of the largest ammocoetes. This also occurred in the same stage for the Salmon River brook lamprey.

Changes in shape and form that occur during the transformation from ammocoete to adult can be seen in Fig. 73 and 74. The transformation from ammocoete to the early transformation stage (Fig. 78-B) apparently occurs rapidly within a month or less (Leach 1940). The first signs of transformation are the enlargement and formation of the eye, while the lateral lips of the head take on a pointed shape. The mouth remains incompletely developed for many months and gradually fills with teeth and increases in size (Leach 1940). The gill openings become rounded and the brachial basket enlarges. The ventral groove of the endostyle disappears in the older forms (Fig. 78-A). The naso-pituitary is enlarged and specialized in the transforming and adult forms (Kleerekoper and van Erkel 1960). Leach (1940) described detailed changes in I. fossor by observing metamorphosis in the laboratory. He observed that the intestine in large ammocoetes was a few millimetres in diameter and full of food, but in transforming larvae the intestine was empty and reduced in diameter to less than one millimetre. The intestines of British Columbia transforming larvae showed the same reduction in size and it also contained little or no food.

Transforming larvae were obtained from British Columbia streams by digging in the sand, leaf and mud sediment beds during the late summer or early fall. All specimens of

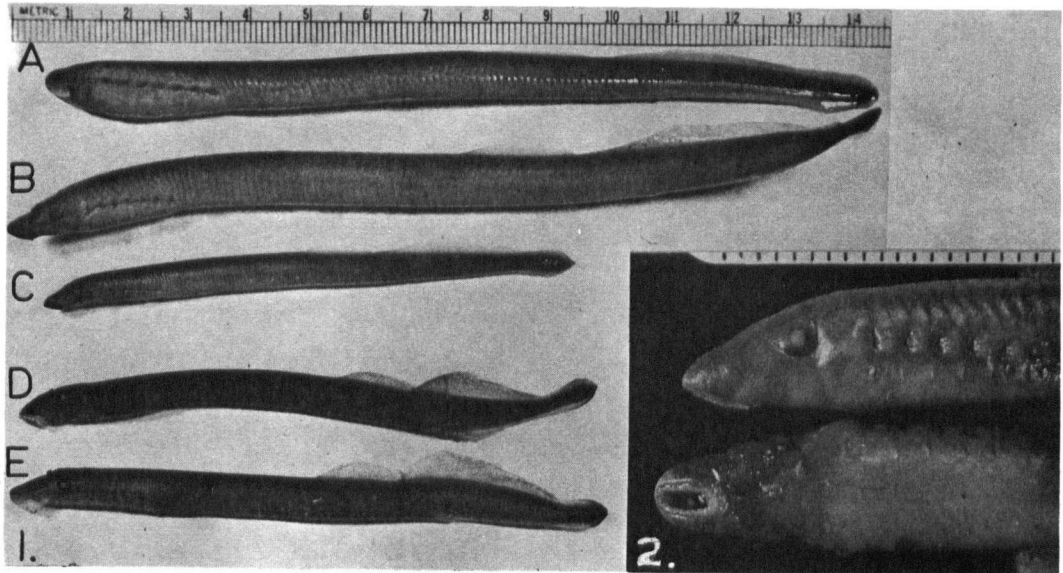


Fig. 74 A comparison of the size and shape of transforming larva of L. planeri. A- ammocoete. B- large transforming ammocoete (Tsolum River) C- small transforming larva. D- female adult (Salmon River). E- male adult (Salmon River).

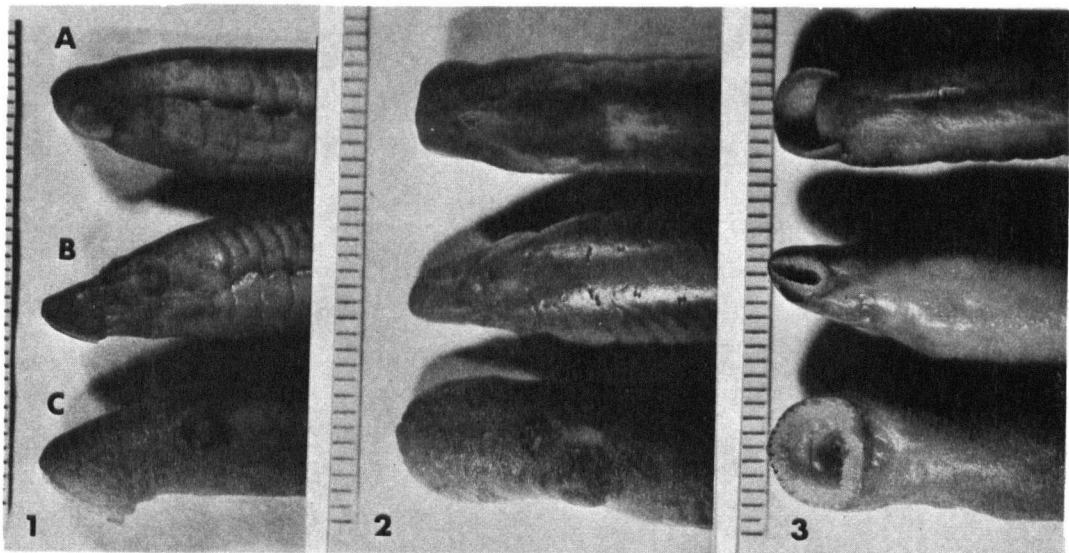


Fig 75 A comparison of the head of L. planeri.
 1- Lateral view. 2- Ventral view.
 3- Dorsal view.
 A- Ammocoete. B- Transforming adult.
 C- Adult (length- 140 mm.).

transforming larvae were taken from deep water (> 3 feet). Transforming larvae were never collected in winter from the Salmon River. This suggests that the transforming larvae occupy a habitat that is not sampled or can escape the collecting device. Leach (1940) observed transforming larvae in the laboratory and found they appeared to be hiding with the pharynx extended above the burrow and retracted into the burrow when danger threatened. Ammocoetes will reburrow under similar circumstances. Gage (1928) reported that transforming lamprey remain in the mud and sand like the larvae, but they are often found in deeper water.

Entosphenus

Transforming larvae were collected in the Big Qualicum River in August indicating that transformation would start in July. No transforming larvae were obtained in the fall in other rivers of British Columbia but larvae in the late transformation stage were obtained in the Nicola and Thompson Rivers in December and March. This indicates a rapid transformation or a fall transformation. Transforming Entosphenus larvae are smaller in size than Lampetra larvae although the Nicola River larvae should be larger as they were collected in March. Collections suggest that transformation takes one year to complete as transformed larvae or early adult stages were collected on the irrigation screens of the Nicola River in August (C.C. Lindsey, personal communication). The presence of a rest period was not determined but the absence of large ammocoetes in the Nicola River could mean reduced

growth or absence of the rest period. The same changes in shape occur in transforming Entosphenus as those in Lampetra.

D. Community Relationship and Mortality

Lampetra

Lampreys are the most abundant permanent fish-like residents in the Salmon River. They utilize diatoms and decaying organic matter of the stream as their major food. This food is not utilized by fishes of the stream so no competition for a food source exists between fishes and ammocoetes. However, in the Salmon River, the microscopic algae and detritus is used by ammocoetes, fresh water clams (Anodonta), crayfish (Pacifastacus), ephemeroptera nymphs and oligochaetes (Tubifex). The ammocoetes appear to be highly adaptive and successful members of the bottom community of the stream.

The predation upon lamprey ammocoetes by fish, amphibians, birds, and mammals is doubtful because of the fossorial nature of the ammocoete and the distasteful substance in its skin. The greatest mortality in ammocoetes occurs just after hatching when the yolk sac is used up prior to feeding. Piavis (1960) found the highest mortality rate in the landlocked sea lamprey occurred from hatching to the pre-larvae stage. Lennon (1955) reported a large percentage of ammocoetes died soon after hatching. Lamprey eggs and very small emergent ammocoetes were eaten by salmonid fry in the laboratory. However, in the stream the adhesive eggs are securely buried in the nest and ammocoetes emerge at night, thus escaping

predation, as is indicated by a lack of ammocoete remains in the fry stomachs.

Potential lamprey predators such as the blue heron (Ardea herodias), racoon (Procyon lotor), and the mink (Mustela vison) are present in the Salmon River area, but due to the abundance of salmon and trout fry throughout the year, it is unlikely that they would burrow into the mud for ammocoetes.

On numerous occasions observations were made of predation by Ephemeroptera nymphs and small crayfish upon ammocoetes burrowed in the mud. The raven (Corvus corax) was observed eating spawning Lampetra on five occasions and many marks similar to that made by a bird's bill have been seen in Lampetra and Entosphenus in the Salmon River.

Hardisty (1961) found, " a relative uniform rate of mortality which the estimates show is hardly surprising in view of the sheltered and stable habitat of the ammocoetes, where except during metamorphosis, there is little tendency for segregation of the animals with respect to their age". He assumes that there is a very heavy mortality during the first few months of larval life, especially in the period when the newly emergent ammocoetes are drifting downstream to the ammocoete beds and again during the vulnerable phase of metamorphosis. Mortality after hatching was observed in the Salmon River lamprey, but mortality of emergent ammocoetes and transforming larvae was not observed.

Entosphenus

The community relationships of ammocoetes of

Entosphenus are probably similar to those of Lampetra. Adult Entosphenus are suspected of having greater mortality due to fish predators in the sea. The population explosion in the Great Lakes of Canada of the landlocked sea lamprey has been rarely equalled in history and can be attributed in part to the absence of predators or biotic control in the fresh water environment. The endemic fresh water forms, "offer little or no control by competition, disease, parasitism, or predation" (McLain 1951). The discovery of the protective substance in the skin of lamprey which protects them from many species of predacious fresh water fish, may account for the low mortality rate. However, there are few records of lampreys in stomach analysis of marine fishes. Adult lampreys were recorded in the stomach of a sperm whale off the Queen Charlotte Islands and from the mouth of a fur seal off Cape Flattery (Pike 1953) which indicate that lampreys go many miles into the open sea and would be susceptible to great predation.

The effect of Entosphenus parasitism on the fish of the sea and certain Vancouver Island lakes is pronounced but the extent to which fish are killed or affected by the parasite is not known.

The number of ammocoetes in rivers and adults in lakes and the sea was substantial in many areas of British Columbia. Their effect on other community members was difficult to determine. Limited observations from the Salmon River suggest that ammocoetes occupy a niche and exploit a food supply that is not utilized by many other community members.

DISCUSSION

Lampreys are very common in the coastal streams in British Columbia, but they have been studied very little. Lamprey ammocoetes occupy the soft mud and sand beds in quiet pools and along the bank where sediments accumulate when the current is reduced. Most stream surveys fail to include lampreys as part of the aquatic fauna because of the lampreys' fossorial nature and restricted distribution to certain sections of stream bottom.

The distribution of lampreys within the coastal streams is incompletely known but extensive collecting may find them occupying most streams. All streams examined on Vancouver Island revealed lamprey ammocoetes as residents. The size of E. tridentatus populations and their distribution along the coast should reveal the extent of predation.

The systematics of British Columbian brook lamprey is in need of revision as the Salmon River population and others examined are sufficiently different from the European form to warrant its being given a separate species name. There appear to be many races of L. planeri in British Columbia that have different tooth patterns, myotome counts, and growth rates. A key to separate large ammocoetes of L. planeri from those of E. tridentatus is presented, but a key to ammocoetes of smaller size classes is needed. Separation of larval ammocoetes by the size of gonads using the method used by Hardisty (1960) seems to offer possibilities. The

position of L. ayresi and its life history is unknown except for a few parasitic adults that have been collected on fish in the Strait of Georgia.

The spawning behaviour of lampreys offers a rich and unexplored field for the comparative ethologist. The primitive phylogenetic position offers interesting starting points to trace origins and evolutionary development of spawning behaviour found in fish. Adult lampreys will spawn readily in still or running water in an aquarium containing gravel, yet feeding and conditioning requirements present in fish are apparently almost non-existent. The change in spawning behaviour with temperature changes presents an interesting behaviour pattern.

The effect of temperature on spawning behaviour of L. planeri may be present in other species of lampreys and might help to explain aspects of their biology. The sex-ratio of spawning adults from the Salmon River was found to be predominantly female at the start of the season, but later in the season males predominated (also recorded by Surface, 1897). A review of the data presented by Applegate (1950) on the sex-ratio in Carp Creek reveals that there may be some correlation between sex-ratio and temperature as well as between sex-ratio and abundance and year class size. In his observations the lowest sex-ratio in 1947 and 1948 imply that the temperature was never above 60°F. until late May. In 1949 the temperature was above 60°F. twice in early April and May and the sex-ratio was the highest in this year.

In 1947 his data showed a 5:1 ratio throughout the season with a 2:1 ratio in early May and a 3:1 ratio in June. From the Salmon River observations the low temperatures may be responsible for causing the males to bury in the gravel or becoming less active; hence they will not be collected as readily as the females.

Collections of adult lampreys for sex-ratio analysis should be made at regular intervals throughout the season to overcome the sampling error associated with behaviour differences caused by temperature. Correction for a longer life of males during the spawning season should also be considered in sex-ratio determinations. The L. planeri males of the Salmon River were found to live considerably longer than the females at all temperatures tested. Zanandrea (1961) found that the sex-ratio of Italian lampreys increased throughout the spawning season and he suggested that this might be due to the greater survival rate of the male. However, from the Salmon River data, low stream temperature as well as longer life of males could be suspected. Hardisty (1954) suggested that the difference in sex-ratio in lampreys may be due to environmental conditions such as temperature and nutrition.

The comparative embryology of British Columbian lampreys could reveal basic similarities that could be used to trace the evolution of different species of lampreys. The early ammocoete life may reveal taxonomic characteristics that could be used to separate different species. The range of temperature tolerance and the effect of temperature on

development should prove helpful in understanding the biological requirements and tolerance ranges that the animals can withstand (similar to Piavis 1955). The mortality during hatching is very important because the stage when the yolk-sac is exhausted but before the juvenile becomes dependent on its own ability to feed is considered to be the critical stage in early life of most fishes (Beverton and Holt 1956).

Sampling methods and size are extremely important in presenting an unbiased description of the population. If only one sampling method is used it will be very unlikely to be representative of all age classes (Ricker 1958). A great variety of collecting methods that sample all stream habitats would most likely be representative of the population. Most workers have used either electric shockers or scooped the sediments onto the shore. The first method selects for the larger specimens while the second does not produce adequate samples of the larger ammocoetes. Both of these methods plus downstream traps would produce the best sampling. Different sections of the river, or even sections of the same pool, produce different size classes, thus the entire length of large sections of the river and each of the bottom types should be sampled to account for drifting or migrating fractions of the population.

The biology of ammocoetes is very difficult to interpret and study in the stream environment. It is difficult to determine movement of ammocoetes in the stream since small ammocoetes are impossible to mark by existing methods. However.

organic dyes have recently proven successful in marking lampreys (Wigley 1952). The protective nature of the mechanism by which emergent ammocoetes leave the gravel at night and settle downstream in the pool areas is poorly understood. Harden-Jones (1955) indicated from laboratory experiments that ammocoetes are photokinetic but his data also indicated that ammocoetes are slightly thigmotaxic. This could explain the possible need by ammocoetes to have mud in contact with the body surface. A thigmotaxic response in conjunction with diurnal or circadian rhythms could account for downstream migration and distribution in the stream. Different year classes are collected in different habitats or bottom types, but why each size group prefers a particular bottom type or current velocity is not known.

Detailed analysis of the filter feeding mechanism of ammocoetes requires further study. The endostyle net can apparently pick out diatoms and desmids from mud, yet protozoans and organic matter such as starch are rejected. The rate of food passage through the gut and the actual utilization of the material is worthy of consideration.

Ammocoetes seem to be able to withstand long periods without food as is indicated by a reduction in growth and food intake during the winter months. This must cause change and shifts in the metabolic requirements of the animal. The reduction of the gut at transformation indicates a period of little or no feeding in the late ammocoete stage. The rest period described by Leach (1940) may also be associated with

a cessation of feeding. The adults of both species studied do not feed from the early fall until spawning, but the fat accumulated by the ammocoetes of L. planeri, and from a parasitic early adult life of E. tridentatus is used to keep the animal alive.

The length of ammocoete life has occupied the core of most lamprey work in the past. However, the nature of the animal's biology and the difficulty in separating the year classes may have presented distorted and inaccurate information in view of recent information as to the presence of a rest period. Shortening in length at transformation, the presence of a rest period, differential growth rates between the sexes, and differences in individual growth that originate from a long spawning period make the analysis of Salmon River data very difficult. However, growth experiments could eliminate this shortcoming and check length-frequency data. Leach (1940) has shown that by growing ammocoetes the length-frequency analysis produces (usually) an age considerably smaller than the actual age of the animal. Strauffer (1962) prevented recruitment in the sea lamprey and allowed the population to go to extinction to show that larval life is longer than previously calculated. Wigley (1959) found a better estimation of age up to transformation can be obtained from weight-frequency distributions.

The determination of age structure and growth in lamprey populations by the probability paper method (Harding (1954) for analysis of length-frequency distributions offers

greater efficiency than the biased visual examination of modes. However, certain assumptions and limitations must be considered before the method can be undertaken. Each dominant year class may be represented by a mode in a simple case but there is always a possibility that the sample of ammocoetes may possess one or more scarce broods between the modes. The major mode may also be composed of two or more overlapping distributions and must be considered as well as the type of distribution present in the population. Normal distributions within each mode are usually assumed, but distributions should be statistically examined. The three assumptions suggested by Ricker (1958) seem to apply to the lamprey population analysed when a von Bertalanffy growth curve is assumed. These are:

1. That there is no difference between year-classes in respect to rate of growth at any given age.
2. That the fish taken constitute a random sample of each of the age-classes involved (not necessarily a random sample of several age-classes simultaneously).
3. That there be no correlation between size of a fish within an age-class, and the mortality rate to which it is subject.

It is worth noting that an analysis which gives a satisfactory fit may not necessarily be the most complete picture of the facts which may really conform to one of the many complex solutions. There may be smaller groups within the samples and each normal curve may in essence be bimodal if both sexes are represented. However, neither the graphic method nor any other will give a complete and undisputed solution. The simplest solution is likely to be the most

significant, biologically as well as statistically (Harding 1949).

Transformation of lamprey ammocoetes is poorly understood, but the mechanism that initiates the change has been the subject of speculation by many workers. Transformation was thought to be associated with the formation of the thyroid gland or unique semi-follicles within the endostylar organs (Leach 1939). The semi-follicles are thought to represent the transformation tissue and accounts for specialized differentiation of the animal rather than growth in length. Remy (1922) and Leach (1944, 1946) injected thyroid and iodine compounds into ammocoetes but this failed to produce metamorphosis. Horton (1934) initiated anuran metamorphosis by injecting thyroid from the adult lamprey. The endostyle of the ammocoete contained no iodine (Knowles 1941). Knowles fed tadpoles ammocoete endostyles but no metamorphosis occurred. He also tried to accelerate metamorphosis by injecting anterior-pituitary extract, but this was unsuccessful. Pickford and Atz (1957) anticipate that hypophysisectomy would prevent the metamorphosis of ammocoetes.

In tadpoles a short period of starvation just before metamorphosis is said to accelerate the transformation into the adult form (Barfuth 1887, quoted by Thompson 1942). Hardisty (1961) suggests that a decline in abundance of phytoplankton in late summer might be responsible for the seasonal onset of metamorphosis in lampreys. However, the lampreys of Leach (1940) and the lampreys studied here showed a reduced

intestine and an absence of food at the start of metamorphosis in late summer. Larger ammocoetes than the transforming larvae were actively feeding and their intestines were full of phytoplankton. This suggests that transformation is associated with a cessation of feeding by the ammocoetes.

Parasitism in the lake environment and in the sea is poorly understood for British Columbia lampreys. Parasitism has been recorded in Elsie Lake and the sea from collections of small adults or observations of scars. Larger lampreys have been recorded attached to large cutthroat trout in Cowichan Lake.

The occurrence of landlocked races of lampreys in Elsie and Cowichan Lakes is suspected but little study had been directed to this area until the last few years and information is still inconclusive. The extremely small size of scars on the Elsie Lake trout is indicative of a reduction in size that is associated with landlocked races.

The effect of parasitic lampreys on marine fish has produced few records of incidence except for troll-caught salmon (Milne 1960, personal communication). It would seem reasonable to assume that if lampreys can seek out and attach to open water fish like the salmon, that they would have little difficulty attaching to slower moving, bottom dwelling fish. If lampreys are preying on other fish besides salmon, the incidence may not be recorded or may be less common. No evidence of lamprey killing fish has been presented in British Columbia.

The homing instinct of lampreys offers a unique field for study, especially since Wigley (1952) has found that organic dyes can be used to mark lamprey successfully. The long migrations of E. tridentatus up the Fraser River and Skeena River certainly suggest a homing tendency.

Lamprey predation in Cowichan and Elsie Lakes and in the sea may be a threat to the fish population. However, the problem must be given serious study before a realistic appraisal can be made. Lake populations must be carefully watched if they become landlocked. The use of the lampricide TFM (3-trifluor-methyl-4 nitrophenol) has been very successful and popular in killing ammocoetes in Eastern North American streams. The chemical kills ammocoetes in the mud but does not affect other fish (Applegate et al. 1957). This chemical could be used to reduce the number of E. tridentatus ammocoetes in the streams and lakes where populations and parasitism warrant it. Lake lampreys (Kennedy 1958) have complicated the control problem in the Great Lakes by spawning in the lakes and thus making control impossible.

The evolution or speciation of non-parasitic lampreys from parasitic lampreys has received much speculation in the past, Hubbs (1924), Zanandrea (1959, 1961), and Hardisty (1963). A non-parasitic life is associated with a supposed shortening of the life cycle, removal of the migratory phase, shortening of the length of the body, and a reduction in dentition and fecundity. "The degenerate or brook lampreys appear to have been independently derived from different parasitic species",

according to Hubbs (1924). Zanandrea (1961) discussed speciation of lampreys and arranged them in pairs where non-parasitic forms have evolved from parasitic forms (present in the genus Ichthyomyzon, Lampetra, and Eudontomyzon).

One possible paired group of lampreys in British Columbia is that of L. planeri (non-parasitic) and L. ayresi (parasitic, earlier called L. fluviatilis). The great similarity between the pair indicates the recent evolutionary divergence of the two species (Hardisty 1963). However, this pair could be North American extensions of European L. planeri and L. fluviatilis that have been separated geographically and have had time to differentiate considerably from the parent form. No paired form of E. tridentatus occurs at present but a small race that is shorter in length may be evolving. This form may be estuarine in its parasitic life and may be similar to a landlocked smaller form that is suspected in Elsie and Cowichan Lakes.

Paired lampreys are usually morphologically very similar and develop along parallel lines but their biology is very different (Zanandrea 1961). One of the paired species does not feed after metamorphosis while the other (parasitic) form preys on fish. In the non parasitic form the gonads begin to develop during metamorphosis (a small egg number), but in the parasitic forms, gonads do not develop until the end of the feeding stage (large egg number).

The formation of a landlocked race from a parasitic lamprey seems to indicate the first step in divergence to a

non-parasitic existence. Landlocked sea lampreys are characterized by a reduction in size and fecundity, but a reduced mortality usually causes an explosive increase in numbers. Landlocked sockeye salmon or kokanee Oncorhynchus nerka in British Columbia lakes have shown similar types of changes to those of landlocked lampreys. Kokanee have reduced size and egg number but have increased in numbers when their anadromous migration was forsaken. The landlocked forms of parasitic lampreys have caused great reductions in the commercial fishery (P. marinus) in the Great Lakes of North America (Wigley 1959), and the little known landlocked form of L. fluviatilis of Lake Onega and Lake Ladoga in Russia (Berg 1931). It will be interesting in these instances to observe the direction of evolution of the landlocked lampreys after the fish population is removed or reduced. Laboratory rearing of the landlocked form and removal of the feeding stage or subjecting them to salinity changes could have interesting implications to lamprey life cycles.

The interactions between lampreys and other community members have never been investigated. Ammocoetes seem to occupy a habitat and exploit a food supply (algae) that is unused in most stream environments. The protective nature of the skin, reduced predation, fossorial habits, and nocturnal behaviour enable ammocoetes to have a low mortality rate. Speculation as to why lampreys dominate the fresh water environment while their numbers are kept at a low level by a period in the sea suggests some interesting ecological relations. The

difference in feeding habits of predatory fish in both habitats (more swallows in the sea) or just increased numbers of predators may cause the difference. The behaviour of lamprey prey in the lakes may be quite different from that of different species in the sea. The landlocked form has a definite survival advantage despite the increased egg number of the sea lamprey.

Lampreys offer a fascinating and readily available source of interest that warrants further extensive and specific biological study beyond the scope of the present introductory work in British Columbia.

SUMMARY OF SPAWNING BEHAVIOURA. Spawning Requirements

1. Physiologically mature sex products.
2. Gravel bottom is essential.
3. Temperature above 10°C necessary to initiate spawning.
4. Current of one foot per second preferred but not essential.
5. Shade preferred but not essential.

B. Prespawning

1. Gather near the riffle areas.
2. Active movement and searching on the riffle area (nocturnal) .
3. Play with stones and individual mock spawning actions.

C. Nest Construction

1. Rock lifting, temperature governs the sex that initiates the action.
2. Combined rock lifting and digging.
3. Digging action.

D. Spawning Sequence

1. Seeking out partner and courting until partner moves to nest.
2. Courting and head grasping by the male.
3. Undulating female drapes body in the nest.
4. Sex act, head grasping and entwining of the tail about the female, vibrations and release of sex products into the gravel.
5. Eggs are covered and attached to sand grains in the

bottom of the nest.

6. Short rest period, one or both leave the nest for a period.
7. Return to nest and repeat the procedure.
8. Temperature modifies the behaviour of sexes during spawning .
9. Communal spawning and coiling are associated with high intensity spawning.

E. Post Spawning

1. All animals die shortly after spawning - temperature controls the period of life.

SUMMARY OF THE LIFE CYCLES

A. Lampetra planeri (as outlined by Leach, 1940)

1. Eggs are deposited in streams from April to June.
2. Embryonic period - two to four weeks and dependent on the temperature.
3. Ammocoete growth period of five or more years buried in the mud, filter feeding.
4. Ammocoete rest period of one year with reduced growth and reduction in size before transformation (speculation only).
5. Early transformation period from August to November. Feeding stops and great changes in body form occur.
6. Immature adult period from November to March. Transformation is completed and the sex organs enlarge.

7. Active adult period and spawning- from April to July.
8. Post-spawning adult period- a few days to a month.
Duration of ammocoete cycle more than five years.
Duration of life cycle from egg to adult more than six years.

B. Entosphenus tridentatus

1. - 5. similar to Lampetra
6. Late transformation and migration to sea- November to August. Stops feeding in the stream, but begins parasitic life when it enters lakes or the sea.
7. Active parasitism on fish in the sea- twelve to twenty months.
8. Migration upstream - July to September.
9. Immature adult stage- October to March. No feeding, hiding under stones in the stream.
10. Active adult or spawning period - April to July.
11. Post-spawning period- one or two days.
Duration of ammocoete cycle is more than five years.
Duration of life cycle (egg to adult) is more than seven years.

CONCLUSIONS

1. Eggs of L. planeri started hatching in 15 days at 15°C. and in 13 days at 17°C.. E. tridantatus eggs started hatching four days later than L. planeri at the same temperature (15°C.).
2. Two to three week old larvae emerge from the gravel at night, are carried downstream by the current to the soft mud bottom where they bury themselves when the current is reduced.
3. Small ammocoetes cannot maintain themselves on any bottom when the current is greater than one foot per second.
4. Emergent ammocoetes are unable to penetrate sand bottoms while larger ammocoetes can penetrate most bottoms but they prefer a sand, leaf and silt bottom.
5. The greatest concentration of ammocoetes were found in the sand, leaf and silt beds of the pool areas at times of reduced flow.
6. Small ammocoetes change their burrows or move about in the mud during each day.
7. Large ammocoetes of L. planeri can be separated from those of E. tridentatus by myotome counts and examination of pigment areas.
8. British Columbia L. planeri is quite different taxonomically from the European form of the same species.
9. The Salmon River adult L. planeri represents a dwarf race of the brook lamprey.

10. Two distinct size groups of E. tridentatus are present in the Salmon River.
11. Incidence of E. tridentatus parasitism occurs in Elsie and Cowichan Lakes on Vancouver Island and in the sea.
12. Greatest incidence of parasitism by E. tridentatus is confined to the early spring in the lakes and to the summer in the sea.
13. More female L. planeri were collected in the lower Salmon River than in the upper river.
14. Female L. planeri are significantly larger than males in the Salmon River.
15. The egg diameter of both species is similar. The range of egg number for L. planeri is 1,100 - 3,700 and that of E. tridentatus is 10,000 - 106,100.
16. Adult L. planeri spawn at temperatures above 10^oC in the stream but at lower temperatures the females remain active yet the males bury into the gravel.
17. The spawning behaviour is very similar between the two species examined and that recorded for other species.
18. A long spawning period from April to July occurs for L. planeri in the Salmon River, low temperature increases the period.
19. Spawning adult L. planeri prefer riffle areas in the stream that are shaded and contain a current greater than 1 foot per second.
20. No intromission occurs during the spawning act in both species.

21. Temperature has a marked effect on the initiation of nest construction and spawning behaviour between the sexes of L. planeri.
22. Communal spawning and coiling are stages of high intensity spawning when one or more females deposit most of their eggs in one nest.
23. No pair bond exists between partners of L. planeri during spawning.
24. Males live longer than females during the spawning period.
25. The length of the spawning period is dependent on temperature for L. planeri.
26. Intestines of ammocoetes of L. planeri contained predominantly diatoms during the spring and summer, but detritus was most prevalent during the winter months.
27. Lamprey adults and ammocoetes are not eaten by the salmonid and other fish of the Salmon River.
28. The skin of lampreys contains a protective substance that is distasteful to certain fish.
29. Length-frequency analysis should be carried out only on large samples taken from many different habitats and with many different collecting methods.
30. Ammocoetes of L. planeri showed little growth during the winter of the first two years of life.
31. Ammocoetes should be marked and grown in a stream environment to test length-frequency data and the presence of a rest period.

32. The growth curve of the ammocoetes of L. planeri and E. tridentatus is very similar for the populations examined.
33. Probability paper provides a most efficient and unbiased graphic statistical method for analysis of polymodal length-frequency distribution and age determination for lamprey populations.

LITERATURE CITED

- Applegate, V.C., 1950a. Natural history of the sea lamprey, Petromyzon marinus, in Michigan. U.S. Dept. Int., F.W.S., Spec. Sci. Rept., Fish # 55: 237.
- _____, 1950b. Sea lamprey spawning runs in the Great Lakes. Spec. Sci. Rept. U.S. Fish Wildl. Serv. No. 61: 1-49.
- Baerends, G.P., 1957. The ethological analysis of fish behaviour. The Physiology of Fishes, Edited by M.E. Brown, Academic Press, New York, London, Vol: II.
- Berg, L.S., 1931. A review of the lampreys of the northern hemisphere. Annuaire Du-Mussee Zoologique De L'Academic Des Science De L'urss, Vol. XXXII: 87-116.
- Beverton, J.H., and S.J. Holt, 1956. On the dynamics of exploited fish populations. Her Majesty's Stationery Office, London.
- Carl, C.G., 1953. Ecological survey of Cowichan River and tributaries. Journ. Fish. Res. Bd. of Can. 6 (1): 28-39.
- Carl, C.G., W.A. Clemens, and C.C. Lindsey, 1959. The fresh-water fishes of British Columbia. British Columbia Provincial Museum, Handbook No. 5: 25-30.
- Cassie, R.M., 1954. Some use of probability paper in the analysis of size frequency distribution. Australian J. Marine and Fresh-water Res. 5: 513-522.
- Churchill, W.S., 1947. The brook lamprey in the Brule River. Trans. Wisc. Acad. Sci., Arts and Lett., 37: 337-346.
- Coots, Millard, 1955. The Pacific lamprey, Entosphenus, above Copco Dam, Sisiyou, County Cal. Cal. Fish and Game, 41 (1): 18.
- Creaser, C.W., and C.S. Hann, 1929. The food of larval lampreys. Papers Mich. Acad. Sci., Arts and Lett., 10: 433-437.
- Creaser, C.W., and C.L. Hubbs, 1922. A revision of the Holarctic lampreys. Occ. Papers Mus. Zool. Univ. Mich. No. 120: 1-14.

- Dean, B., and F.B. Summer, 1898. Notes on the spawning habits of the brook lamprey (Petromyzon wilderi). Trans. N.Y. Acad. Sci.: 331-334.
- Dendy, J.S., and D.C. Scott, 1953. Distribution, life history and morphological variation of the southern brook lamprey. Copeia for 1953, (3): 152.
- Enequist, P., 1937. Das Bachneunauge als ökologische Modifikation des Flussneunauge. Ueber die Arkiv. Zool., 29:20: 1-22.
- Gage, S.H., 1893. Lake and brook lampreys of New York, especially those of Cayuga and Seneca Lakes. Wilder Quarter Century Book, Comstock Pub. Co., Ithaca, New York: 421-493.
- Gage, S.H., 1928. The lampreys of New York State, life history and economics of the Oswega River system. Rep. N.Y. St. Conserv. Dept. Suppl. t. 17th-: 158-91.
- Guibé, 1958. restated by Grassé, P.P., Traite de Zoologie Tome XIII Paris: 1934.
- Hagelin, L.O., 1959. Further aquarium observations on the river lamprey. Oikos 10 (1): 50-63.
- Hagelin, L.O., and N. Steffner, 1958. Notes on the spawning habits of the river lamprey (P. fluviatilis). Oikos 9 (2): 222-238.
- Hardisty, M.W., 1944. The life history and growth of the brook lamprey, Lampetra planeri. J. Anim. Ecol. 13: 110-122.
- _____, 1951. Duration of the larval period in the brook lamprey, Lampetra planeri. Nature, Lond. 167: 38.
- _____, 1954. Sex ratio in spawning populations of Lampetra planeri. Nature, Lond.: 173-874.
- _____, 1957. Embryonic and early life of the brook lamprey. J. Exp. Biol., Vol. 34: 237-252.
- _____, 1961a. Studies on an isolated spawning population of brook lampreys (Lampetra planeri) J. Anim. Ecol. 30: 339-355.
- _____, 1961b. Oocyte counts as a diagnostic character for the identification of ammocoete species. Nature, Lond. 191: 1215-1216.
- _____, 1961c. The growth of larval lampreys. J. Anim. Ecol. 30: 357-371.

- Hardisty, M.W., 1963. Fecundity and speciation in lampreys. *Evolution* Vol. 17: 17-22.
- Horton, F.M., 1934. On the relation of the thyroid gland to metamorphosis in the lamprey. *J. Exp. Biol.* II: 257-261.
- Hubbs, C.L., 1924. The life cycle and growth of lampreys. *Pap. Mich. Acad. Sci.* 4 (5): 87-603.
- Hubbs, C.L., and M.B. Trautman, 1937. A revision of the lamprey genus Ichthyomyzon. *Misc. Publ. Mus. Zool. Univ. Michigan.* No. 35:1-109.
- Hurn, D.R., 1962-63. British Columbia Fish and Game Branch, Regional Biologist. Verbal communication and use of unpublished data.
- Ivanova-Berg, 1931. Über die Lebensdauer der Larve von Lampetra planeri aus dem Gebiete des Finneschen Busens. *Zool. Anz.* 96: 330-334.
- Jones, F.R. Harden, 1955. Photo-kinesis in the ammocoete larva of the brook lamprey. *J. Exp. Biol.* 32: 492.
- Kelley, C.C. and R.H. Spilsbury, 1939. Soil survey of the lower Fraser Valley. *Can. Dept. Agt. Pub. # 650, Tech. Bull.* 20.
- Kennedy, W.A., 1956. Summary report Fisheries Research Board of Canada, Biological Station, London, Ontario.
- Kleerekoper, H., 1958. The localization of prey by the sea lamprey, Petromyzon marinus. *The Anatomical Record.* Vol. 132 (3): 464.
- Kleerekoper, H., and G.A. van Erkel, 1960. The olfactory apparatus of Petromyzon marinus. *Can. J. Zool.* 30: 211-222.
- Kleerekoper, H., G. Taylor, and R. Walton, 1962. Diurnal periodicity in the activity of Petromyzon marinus and the effect of chemical stimulation. *Trans. Amer. Fish Soc.* Vol. 90 (1).
- Knowles, F.G.W., 1941. The duration of larval life in ammocoetes and an attempt to accelerate metamorphosis by injections of an anterior pituitary extract. *Zool. Soc. Lond. Proc., Ser. A., 1940-42, 110-111: 101-109.*
- Lack, D., 1954. *The natural regulation of animal numbers.* Oxford, Clarendon Press.
- Leach, W.J., 1940. Occurrence and life history of the northern brook lamprey (Ichthyomyzon fossor) in Indiana. *Copeia* for 1940, (1): 21-34.

- Lennon, Robert E., 1955. Artificial propagation of the sea lamprey, P. marinus. Copeia. 1955 No. 3: 235-236.
- Lindsey, C.C., University of British Columbia. Personal communication. 1961.
- Loman, J.C., 1912. Über die Geschlechts differenzierung bei Ammocoetes. Verh. Anat. Ges. Vers. 17: 66-74.
- MacDonald, T., 1957. Ammocoete behaviour. Summary report Fisheries Research Board of Canada, Biological Station, London, Ontario.
- MacDonald, T.H., 1959. Estimates of the length of larval life in three species of lamprey found in Britain. J. Anim. Ecol. 28 (2) 293-298.
- McLain, A.L., 1951. Diseases and parasites of the sea lamprey, Petromyzon marinus, in the Lake Huron basin. Trans. Amer. Fish. Soc., Vol. 81: 94-100.
- McMynn, R.G., and E.H. Vernon, 1954. Some physical and biological observations on the Salmon River- Fort Langley. B.C. Game Commission Report.
- Mansuet, R.J., 1962. Distribution of small newly metamorphosed sea lamprey, Petromyzon marinus, and their parasitism on menhaden, Brevoortia tyrannus, in Mid-Chesapeake Bay during winter months. Chesapeake Sci. 3 (2):137-139.
- Milne, D., 1960. Pacific Biological Station, Nanaimo, B.C., personal communication.
- Newth, H.G., 1930. The feeding of ammocoetes. Nature (London), 126 (3168): 94-95.
- Okkelberg, P., 1922. Notes on the life history of the brook lamprey, Ichthyomyzon unicolor. Pap. Mus. Zool. Univ. Michigan. 522 (9): 125.
- Perlmutter, A., 1951. An aquarium experiment on the American eel as a predator on larval lampreys. Copeia (2): 173-174.
- Pfeiffer, W., 1960. Über die Verbreitung der schreckreaktion bei fischen. Naturwiss. 47: 23; also in Bull. Sta. biol. Arcachon, No. 12.
- Piavis, G.N., 1960. Embryonic stages in the sea lamprey and effects of temperature on development. Fisheries Bulletin 182. U.S. Dept. of the Interior Fish and Wildlife Service.
- Pickford, G.E., and J.W. Atz, 1957. The physiology of the pituitary gland of fishes. New York Zoological Society, New York: 117-121.

- Pike, G.C., 1951. Lamprey marks on whales. J. Fish. Res. Bd. Canada. 84.
- _____, 1953. The Pacific sea lamprey. Progress Reports of the Pacific Coast. Station of the Fisheries Research Board of Canada, No. 97: 3-5.
- Raney, E., 1939. The breeding habits of Ichthyomyzon greenleyi (Hubbs and Trautman). Copeia 2: 111-112.
- Regan, C.T., 1911. A synopsis of the marsipobranchs of the order Hyperoartii. Ann. Mag. Nat. Hist., Ser. 8, 7: 193-204.
- Reighard, J., and H. Cummins, 1916. Description of a new species of lamprey of the genus Ichthyomyzon. Occ. Pap. Mus. Zool., Univ. Mich., (3): 12.
- Remy, P., 1942. L'iodée et la métamorphose de l'ammocoète branchialis et Petromyzon planeri (Bloch). C.R. Soc. Biol. Paris, 86: 129-131.
- Rensch, B., 1959. Evolution above the species level. Methuen, London.
- Ricker, W.E., 1958. Handbook of computations for biological statistics of fish populations. Fisheries Research Board of Canada. Bulletin No. 119.
- Sawyer, 1959. Burrowing activities of the larval lampreys. Copeia for 1959, (3): 256-257.
- Schroll, F., 1959. Zur Ernährungsbio-logie der steirischen ammocoten Lampetra planeri (Bloch) und Eudontomyzon danfordi (Regen). Int. Rev. Ges. Hydrobiol., 44 (3): 395-421.
- Schultz, L.P., 1930. The life history of L. planeri (Bloch) with a statistical analysis of the rate of growth of the larvae from western Washington. Occ. pap. Mus. Zool., Univ. Mich., (221): 1-35.
- Scott, D.P., 1956-57. Spawning requirements of sea lamprey. Appendix O. Annual Report of the Biological Station and the Technological Unit, London, Ontario, 1956-57.
- Stauffer, T.M., 1962. Duration of larval life of sea lampreys in Carp Lake River, Michigan. Trans. Amer. Fish. Soc. Vol. 91 (4): 422-423.
- Surface, H.A., 1897. The lamprey of central New York. Bull. U.S. Fish. Comm. 17: 209-215.

- Thomas, J.D., 1962. The food and growth of brown trout (Salmo trutta) and its feeding relationships with the salmon parr (Salmo salar L.) and the eel (Anguilla anguilla L.) in the River Terfy, West Wales. Journal Animal Ecology: 31.
- Thomas, M.L.H., 1963. Studies on the biology of ammocoetes in streams. Manuscript Report Series No. 742, Fisheries Research Board of Canada.
- Thompson, D'Arcy W., 1942. Growth and form. Cambridge.
- Vladykov, V.D., 1951. Fecundity of Quebec lampreys. The Canadian Fish Culturist, The Dept. of Fisheries of Canada.
- _____, 1955. Lampetra zanandreaei, a new species of lamprey from Northern Italy. Copeia, 1955. 3: 215-223.
- Vladykov, V.D., and W.I. Follett, 1958. Redescription of Lampetra ayresii (Günther) of Western North America, a species of lamprey (Petromyzontidae) distinct from Lampetra fluviatilis (Linnaeus) of Europe. 15 (1): 47-77.
- Wickett, P. Pacific Biological Station, Nanaimo. Personal communication and use of unpublished data.
- Wigley, R.L., 1952. A method of marking larval lampreys. Copeia, 1952. No. 3: 203-204.
- _____, 1959. Life history of the sea lamprey of Cayuga Lake, New York. U.S. Dept. Int. Fish and Wildlife Serv. Fish Bull. 59 (154): 561-617.
- Young, J.Z., 1935. The photoreceptors of lampreys. I. Light sensitive fibres in the lateral line nerves. Journ. Exp. Biol. 12 (3): 229-238.
- Young, J.Z. and C.W. Bellerby, 1935. The response of the lamprey to injections of anterior lobe pituitary extract. J. Exp. Biol. 12: 246-253.
- Zanandrea, G., 1951. Rilievi e confronti bometrici e biologici sul Petromyzon (Lampetra) planeri (Bloch). Nelle acque della marca trecigiana. Bolletino di Pesca, Piscicoltura e Idrobiologia Anno. XXVII, 6: 53-78.
- _____, 1954. Note sulla ecologia e distribuzione in Italia della lampreda di ruscella (Lampetra planeri), (Bloch). Boll. Pesca Piscic. Idrobiol. 8: 1-20.
- _____, 1961. Studies on European lampreys. Evolution, 15 (4): 523-534.