

CECW-EH-D  Engineer Manual 1110-2-1614	Department of the Army U.S. Army Corps of Engineers Washington, DC 20314-1000	EM 1110-2-1614  30 June 1995
	Engineering and Design  DESIGN OF COASTAL REVETMENTS, SEAWALLS, AND BULKHEADS	
	<b>Distribution Restriction Statement</b> Approved for public release; distribution is unlimited.	

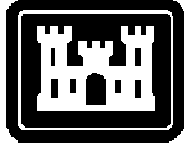

EM 1110-2-1614  
30 June 1995

**US Army Corps  
of Engineers**

**ENGINEERING AND DESIGN**

---

# **Design of Coastal Revetments, Seawalls, and Bulkheads**

**ENGINEER MANUAL**

DEPARTMENT OF THE ARMY  
U.S. Army Corps of Engineers  
Washington, DC 20314-1000

EM 1110-2-1614

CECW-EH-D

Manual  
No. 1110-2-1614

30 June 1995

**Engineering and Design**  
**DESIGN OF COASTAL REVETMENTS, SEAWALLS, AND BULKHEADS**

**1. Purpose.** This manual provides guidance for the design of coastal revetment, seawalls, and bulkheads.

**2. Applicability.** This manual applies to HQUSACE elements, major subordinate commands (MSC), districts, laboratories, and field operating activities (FOA) having civil works responsibilities.

**3. Discussion.** In areas subject to wind-driven waves and surge, structures such as revetments, seawalls, and bulkheads are commonly employed either to combat erosion or to maintain development at an advanced position from the natural shoreline. Proper performance of such structures is predicated on close adherence to established design guidance. This manual presents important design considerations and describes commonly available materials and structural components. All applicable design guidance must be applied to avoid poor performance or failure. Study of all available structural materials can lead, under some conditions, to innovative designs at significant cost savings for civil works projects.

FOR THE COMMANDER:

  
JAMES D. CRAIG  
Colonel, Corps of Engineers  
Chief of Staff

CECW-EH-D

Manual  
No. 1110-2-1614

30 June 1995

**Engineering and Design  
DESIGN OF COASTAL REVETMENTS, SEAWALLS, AND BULKHEADS**

**Table of Contents**

<b>Subject</b>	<b>Paragraph</b>	<b>Page</b>	<b>Subject</b>	<b>Paragraph</b>	<b>Page</b>
<b>Chapter 1</b>			Freeze-Thaw Cycles . . . . .	2-23	2-17
<b>Introduction</b>			Marine Borer Activity . . . . .	2-24	2-18
Purpose . . . . .	1-1	1-1	Ultraviolet Light . . . . .	2-25	2-18
Applicability . . . . .	1-2	1-1	Abrasion . . . . .	2-26	2-18
References . . . . .	1-3	1-1	Vandalism and Theft . . . . .	2-27	2-18
Background . . . . .	1-4	1-1	Geotechnical Considerations . . . . .	2-28	2-18
Discussion . . . . .	1-5	1-1	Wave Forces . . . . .	2-29	2-18
<b>Chapter 2</b>			Impact Forces . . . . .	2-30	2-20
<b>Functional Design</b>			Ice Forces . . . . .	2-31	2-20
Shoreline Use . . . . .	2-1	2-1	Hydraulic Model Tests . . . . .	2-32	2-20
Shoreline Form and			Two-Dimensional Models . . . . .	2-33	2-20
Composition . . . . .	2-2	2-1	Three-Dimensional Models . . . . .	2-34	2-20
Seasonal Variations			Previous Tests . . . . .	2-35	2-21
of Shoreline Profiles . . . . .	2-3	2-1	<b>Chapter 3</b>		
Design Conditions			<b>Revetments</b>		
for Protective Measures . . . . .	2-4	2-1	General . . . . .	3-1	3-1
Design Water Levels . . . . .	2-5	2-1	Armor Types . . . . .	3-2	3-1
Design Wave Estimation . . . . .	2-6	2-2	Design Procedure Checklist . . . . .	3-3	3-1
Wave Height and Period Variability			<b>Chapter 4</b>		
and Significant Waves . . . . .	2-7	2-2	<b>Seawalls</b>		
Wave Gauges and			General . . . . .	4-1	4-1
Visual Observations . . . . .	2-8	2-3	Concrete Seawalls . . . . .	4-2	4-1
Wave Hindcasts . . . . .	2-9	2-4	Rubble-Mound Seawalls . . . . .	4-3	4-1
Wave Forecasts . . . . .	2-10	2-4	Design Procedure Checklist . . . . .	4-4	4-1
Breaking Waves . . . . .	2-11	2-4	<b>Chapter 5</b>		
Height of Protection . . . . .	2-12	2-4	<b>Bulkheads</b>		
Wave Runup . . . . .	2-13	2-4	General . . . . .	5-1	5-1
Wave Overtopping . . . . .	2-14	2-6	Structural Forms . . . . .	5-2	5-1
Stability and Flexibility . . . . .	2-15	2-8	Design Procedure Checklist . . . . .	5-3	5-1
Armor Unit Stability . . . . .	2-16	2-8	<b>Chapter 6</b>		
Layer Thickness . . . . .	2-17	2-10	<b>Environmental Impacts</b>		
Reserve Stability . . . . .	2-18	2-10	General . . . . .	6-1	6-1
Toe Protection . . . . .	2-19	2-11	Physical Impacts . . . . .	6-2	6-1
Filters . . . . .	2-20	2-12			
Flank Protection . . . . .	2-21	2-16			
Corrosion . . . . .	2-22	2-16			

<b>Subject</b>	<b>Paragraph</b>	<b>Page</b>
Water Quality Impacts . . . . .	6-3	6-1
Biological Impacts . . . . .	6-4	6-1
Short-term Impacts . . . . .	6-5	6-2
Long-term Impacts . . . . .	6-6	6-2
Socioeconomic and Cultural Impacts . . . . .	6-7	6-2
Evaluation of Alternatives . . . . .	6-8	6-2

**Appendix A**  
**References**

**Appendix B**  
**Revetments**

<b>Subject</b>	<b>Paragraph</b>	<b>Page</b>
<b>Appendix C</b> <b>Seawalls</b>		
<b>Appendix D</b> <b>Bulkheads</b>		
<b>Appendix E</b> <b>Sample Problem</b>		
<b>Appendix F</b> <b>Glossary</b>		

List of Figures

Figure	Page	Figure	Page
2-1	Monthly lake level forecast . . . . .	2-3	
2-2	Design breaker height . . . . .	2-5	
2-3	Surf parameter and breaking wave types . . . . .	2-6	
2-4	Revetment toe protection . . . . .	2-13	
2-5	Seawall and bulkhead toe protection . . . . .	2-14	
2-6	Toe aprons for sheet-pile bulkheads . . . . .	2-15	
2-7	Value of $N_s$ , toe protection design for vertical walls . . . . .	2-15	
2-8	Use of filter cloth under revetment and toe protection stone . . . . .	2-16	
2-9	Breaking wave pressures on a vertical wall . . . . .	2-19	
2-10	Wave pressure from broken waves . . . . .	2-20	
3-1	Typical revetment section . . . . .	3-1	
3-2	Summary of revetment alternatives . . . . .	3-2	
4-1	Typical concrete seawall sections . . . . .	4-1	
4-2	Summary of seawall alternatives . . . . .	4-1	
5-1	Summary of bulkhead alternatives . . . . .	5-2	
B-1	Quarrystone revetment at Tawas Point, Michigan . . . . .	B-1	
B-2	Quarrystone revetment cross section . . . . .	B-1	
B-3	Large stone overlay revetment at Oahe Reservoir, SD . . . . .	B-2	
B-4	Large stone overlay revetment cross section . . . . .	B-3	
B-5	Field stone revetment at Kekaha Beach, Kauai, HI . . . . .	B-3	
B-6	Field stone revetment cross section . . . . .	B-4	
B-7	Broken concrete revetment at Shore Acres, TX . . . . .	B-5	
B-8	Broken concrete revetment cross section . . . . .	B-5	
B-9	Asphaltic concrete revetment cross section . . . . .	B-6	
B-10	Concrete tribars (armor unit) test section at CERC, Fort Belvoir, VA . . . . .	B-7	
B-11	Concrete tribar revetment cross section . . . . .	B-7	
B-12	Formed concrete revetment, Pioneer Point, MD . . . . .	B-8	
B-13	Formed concrete revetment cross section . . . . .	B-8	
B-14	Concrete revetment blocks . . . . .	B-9	
B-15	Gobi block revetment, Holly Beach, LA . . . . .	B-10	
B-16	Gobi block revetment cross section . . . . .	B-10	
B-17	Turf block revetment, Port Wing, WI . . . . .	B-11	
B-18	Turf block revetment cross section . . . . .	B-11	
B-19	Nami Ring revetment, Little Girls Point, MI . . . . .	B-12	
B-20	Nami Ring revetment cross section . . . . .	B-12	
B-21	Concrete construction block revetment, Fontainebleau State Park, LA . . . . .	B-13	
B-22	Concrete construction block revetment cross section . . . . .	B-13	
B-23	Detail of erosion of concrete control blocks . . . . .	B-14	
B-24	Concrete control block revetment, Port Wing, WI . . . . .	B-14	
B-25	Concrete control block revetment cross section . . . . .	B-15	
B-26	Shiplap block revetment, Benedict, MD . . . . .	B-15	
B-27	Shiplap block revetment cross section . . . . .	B-16	
B-28	Lok-Gard block revetment, Jensen Beach Causeway, FL . . . . .	B-16	
B-29	Lok-Gard block revetment cross section . . . . .	B-17	
B-30	Terrafix block revetment, Two Mile, FL . . . . .	B-17	
B-31	Terrafix block revetment cross section . . . . .	B-18	
B-32	Fabriform revetment, location unknown . . . . .	B-18	
B-33	Fabriform revetment cross section . . . . .	B-19	
B-34	Bag revetment at Oak Harbor, WA . . . . .	B-20	
B-35	Bag revetment cross section . . . . .	B-20	
B-36	Gabion revetment, Oak Harbor, WA . . . . .	B-22	
B-37	Gabion revetment cross section . . . . .	B-22	
B-38	Steel fuel barrel revetment, Kotzebue, AK . . . . .	B-23	
B-39	Steel fuel barrel revetment plan and cross section . . . . .	B-23	
B-40	Fabric revetments, Fontainebleau State Park, LA . . . . .	B-25	
B-41	Fabric revetment cross section . . . . .	B-25	

Figure	Page	Figure	Page
B-42	Concrete slab revetment, Alameda, CA . . . . .	B-26	
B-43	Concrete slab revetment cross section . . . . .	B-26	
B-44	Soil cement revetment, Bonny Dam, CO . . . . .	B-27	
B-45	Soil cement revetment cross section . . .	B-27	
B-46	Tire mattress revetment, Fontainebleau State Park, LA . . . . .	B-28	
B-47	Tire mattress revetment cross section . . . . .	B-28	
B-48	Landing mat revetment . . . . .	B-28	
B-49	Windrow revetment . . . . .	B-29	
B-50	Protective vegetative plantings . . . . .	B-30	
C-1	Curved-face seawall Galveston, TX . . . .	C-1	
C-2	Curved-face seawall cross section . . . .	C-1	
C-3	Stepped-face seawall, Harrison County, MS . . . . .	C-2	
C-4	Stepped-face seawall cross section . . . .	C-2	
C-5	Combination stepped- and curved-face seawall, San Francisco, CA . . . . .	C-3	
C-6	Combination stepped- and curved-face seawall cross section . . . .	C-3	
C-7	Rubble-mound seawall, Fernandina Beach, FL . . . . .	C-4	
C-8	Rubble-mound seawall cross section . . . . .	C-4	
D-1	Sheet-pile bulkhead, Lincoln Township, MI . . . . .	D-2	
D-2	Steel sheet-pile bulkhead cross-section . . . . .	D-2	
D-3	Timber sheet-pile bulkhead, possibly at Fort Story, VA . . . . .	D-3	
D-4	Construction details of timber sheet pile bulkhead . . . . .	D-3	
D-5	Aluminum sheet-pile bulkhead cross section . . . . .	D-4	
D-6	Concrete sheet-pile bulkhead, Folly Beach, SC . . . . .	D-4	
D-7	Cellular steel sheet-pile bulkhead, plan and cross section . . . . .	D-5	
D-8	Concrete slab and king-pile bulkhead . . . . .	D-5	
D-9	Concrete slab and king-pile bulkhead cross section . . . . .	D-6	
D-10	Railroad ties and steel H-pile bulkhead, Port Wing, WI . . . .	D-7	
D-11	Railroad ties and steel H-pile bulkhead cross section . . . . .	D-7	
D-12	Treated timber bulkhead, Oak Harbor, WA . . . . .	D-8	
D-13	Treated timber bulkhead cross section . . . . .	D-8	
D-14	Untreated log bulkhead, Oak Harbor, WA . . . . .	D-9	
D-15	Untreated log bulkhead cross section . . . . .	D-9	
D-16	Hogwire fence and sandbag bulkhead, Basin Bayou Recreation Area, FL . . . . .	D-10	
D-17	Hogwire fence and sandbag bulkhead cross section . . . . .	D-10	
D-18	Used rubber tire and timber post bulkhead, Oak Harbor, WA . . . . .	D-11	
D-19	Used rubber tire and timber post bulkhead cross section . . . . .	D-11	
D-20	Timber crib bulkhead cross section . . . . .	D-12	
D-21	Stacked rubber tire bulkhead, Port Wing, WI . . . . .	D-12	
D-22	Stacked rubber tire bulkhead cross section . . . . .	D-13	
D-23	Used concrete pipe bulkhead, Beach City, TX . . . . .	D-13	
D-24	Used concrete pipe bulkhead cross section . . . . .	D-14	
D-25	Longard tube bulkhead, Ashland, WI . . . . .	D-15	
D-26	Longard tube bulkhead cross section . . . . .	D-15	
D-27	Stacked bag bulkhead cross section . . . . .	D-16	
D-28	Gabion bulkhead, possibly in Sand Point, MI . . . . .	D-16	
D-29	Gabion bulkhead cross section . . . . .	D-16	
E-1	Site conditions for sample problem . . . .	E-1	
E-2	Revetment section alternatives . . . . .	E-6	
E-3	Bulkhead section alternatives . . . . .	E-8	

List of Tables

Table		Page	Table		Page
2-1	Relationships Among $T_p$ , $T_s$ , and $T_z$ . . . . .	2-4	E-4	Site Preparation Costs for Revetment Alternative . . . . .	E-9
2-2	Rough Slope Runup Correction Factors . . . . .	2-7	E-5	Material Costs for Armor Stone Revetment Alternative . . . . .	E-9
2-3	Suggested Values for Use in Determining Armor Weight (Breaking Wave Conditions) . . . . .	2-9	E-6	Material Costs for Concrete Block Revetment Alternative . . . . .	E-10
2-4	Layer Coefficients and Porosity for Various Armor Units . . . . .	2-11	E-7	Material Costs for Gabion Revetment Option . . . . .	E-10
2-5	$H/H_{D=0}$ for Cover Layer Damage Levels for Various Armor Types . . . . .	2-11	E-8	Material Costs for Soil- Cement Revetment Option . . . . .	E-10
2-6	Galvanic Series in Seawater . . . . .	2-17	E-9	Summary of Initial Costs for the Revetment Options . . . . .	E-10
6-1	Environmental Design Considerations for Revetments, Seawalls, and Bulkheads . . . . .	6-3	E-10	Material Costs for Steel Sheetpile Bulkhead Option . . . . .	E-11
B-1	Shiplap Block Weights . . . . .	B-15	E-11	Material Costs for Railroad Ties and Steel H-Pile Bulkhead Option . . .	E-11
E-1	Predicted Runup and Required Crest Elevations for Sample Revetments Options . . . . .	E-5	E-12	Material Costs for Gabion Bulkhead Option . . . . .	E-12
E-2	Estimated Toe Scour Depths for Sample Revetment Options . . . . .	E-5	E-13	Summary of Initial Costs for the Bulkhead Options . . . . .	E-12
E-3	Summary of Revetment Design Options . . . . .	E-7	E-14	Summary of Annual Costs for Revetment and Bulkhead Options . . .	E-12



## Chapter 1 Introduction

### 1-1. Purpose

This manual provides guidance for the design of coastal revetments, seawalls, and bulkheads.

### 1-2. Applicability

This manual applies to HQUSACE elements, major subordinate commands, districts, laboratories, and field operating activities having civil works responsibilities.

### 1-3. References

Required and related publications are listed in Appendix A. Bibliographic items are cited in the text by author and year of publication, with full references listed in Appendix A. If any reference item contains information conflicting with this manual, provisions of this manual govern.

### 1-4. Background

Structures are often needed along either bluff or beach shorelines to provide protection from wave action or to retain *in situ* soil or fill. Vertical structures are classified as either seawalls or bulkheads, according to their function, while protective materials laid on slopes are called revetments.

*a. Revetments.* Revetments are generally constructed of durable stone or other materials that will provide sufficient armoring for protected slopes. They consist of an armor layer, filter layer(s), and toe protection. The armor layer may be a random mass of stone or concrete rubble or a well-ordered array of structural elements that interlock to form a geometric pattern. The filter assures drainage and retention of the underlying soil. Toe protection is needed to provide stability against undermining at the bottom of the structure.

*b. Bulkheads and seawalls.* The terms *bulkhead* and *seawall* are often used interchangeably. However, a bulkhead is primarily intended to retain or prevent sliding of the land, while protecting the upland area against wave action is of secondary importance. Seawalls, on the other hand, are more massive structures whose primary purpose is interception of waves. Bulkheads may be either cantilevered or anchored (like sheetpiling) or gravity structures (such as rock-filled timber cribs). Their use is limited to those areas where wave action can be resisted by such materials. In areas of intense wave action, massive concrete seawalls are generally required. These may have either vertical, concave, or stepped seaward faces.

*c. Disadvantages.* Revetments, bulkheads, and seawalls mainly protect only the upland area behind them. All share the disadvantage of being potential wave reflectors that can erode a beach fronting the structure. This problem is most prevalent for vertical structures that are nearly perfect wave reflectors and is progressively less prevalent for curved, stepped, and rough inclined structures that absorb or dissipate increasing amounts of wave energy.

### 1-5. Discussion

The designer is responsible for developing a suitable solution which is economical and achieves the project's purpose (see EM 1110-2-3300). Caution should be exercised, however, when using this manual for anything beyond preliminary design in which the primary goal is cost estimating and screening of alternatives. Final design of large projects usually requires verification by hydraulic model studies. The construction costs of large projects offer considerable opportunities for refinements and possible cost savings as a result of model studies. Model studies should be conducted for all but small projects where limited budgets control and the consequences of failure are not serious.

## Chapter 2 Functional Design

### 2-1. Shoreline Use

Some structures are better suited than others for particular shoreline uses. Revetments of randomly placed stone may hinder access to a beach, while smooth revetments built with concrete blocks generally present little difficulty for walkers. Seawalls and bulkheads can also create an access problem that may require the building of stairs. Bulkheads are required, however, where some depth of water is needed directly at the shore, such as for use by boaters.

### 2-2. Shoreline Form and Composition

*a. Bluff shorelines.* Bluff shorelines that are composed of cohesive or granular materials may fail because of scour at the toe or because of slope instabilities aggravated by poor drainage conditions, infiltration, and reduction of effective stresses due to seepage forces. Cantilevered or anchored bulkheads can protect against toe scour and, being embedded, can be used under some conditions to prevent sliding along subsurface critical failure planes. The most obvious limiting factor is the height of the bluff, which determines the magnitude of the earth pressures that must be resisted, and, to some extent, the depth of the critical failure surface. Care must be taken in design to ascertain the relative importance of toe scour and other factors leading to slope instability. Gravity bulkheads and seawalls can provide toe protection for bluffs but have limited applicability where other slope stability problems are present. Exceptions occur in cases where full height retention is provided for low bluffs and where the retained soil behind a bulkhead at the toe of a higher bluff can provide sufficient weight to help counterbalance the active thrust of the bluff materials.

*b. Beach shorelines.* Revetments, seawalls, and bulkheads can all be used to protect backshore developments along beach shorelines. As described in paragraph 1-4c, an important consideration is whether wave reflections may erode the fronting beach.

### 2-3. Seasonal Variations of Shoreline Profiles

Beach recession in winter and growth in summer can be estimated by periodic site inspections and by computed variations in seasonal beach profiles. The extent of winter beach profile lowering will be a contributing factor in determining the type and extent of needed toe protection.

### 2-4. Design Conditions for Protective Measures

Structures must withstand the greatest conditions for which damage prevention is claimed in the project plan. All elements must perform satisfactorily (no damage exceeding ordinary maintenance) up to this condition, or it must be shown that an appropriate allowance has been made for deterioration (damage prevention adjusted accordingly and rehabilitation costs amortized if indicated). As a minimum, the design must successfully withstand conditions which have a 50 percent probability of being exceeded during the project's economic life. In addition, failure of the project during probable maximum conditions should not result in a catastrophe (i.e., loss of life or inordinate loss of money).

### 2-5. Design Water Levels

The maximum water level is needed to estimate the maximum breaking wave height at the structure, the amount of runoff to be expected, and the required crest elevation of the structure. Minimum expected water levels play an important role in anticipating the amount of toe scour that may occur and the depth to which the armor layer should extend.

*a. Astronomical tides.* Changes in water level are caused by astronomical tides with an additional possible component due to meteorological factors (wind setup and pressure effects). Predicted tide levels are published annually by the National Oceanic and Atmospheric Administration (NOAA). The statistical characteristics of astronomical tides at various U.S. ports were analyzed in Harris (1981) with probability density functions of water levels summarized in a series of graphs and tables. Similar tables are available for the Atlantic Coast in Ebersole (1982) which also includes estimates of storm surge values.

*b. Storm surge.* Storm surge can be estimated by statistical analysis of historical records, by methods described in Chapter 3 of the Shore Protection Manual (SPM), or through the use of numerical models. The numerical models are usually justified only for large projects. Some models can be applied to open coast studies, while others can be used for bays and estuaries where the effects of inundation must be considered.

*c. Lake levels.* Water levels on the Great Lakes are subject to both periodic and nonperiodic changes. Records dating from 1836 reveal seasonal and annual changes due to variations in precipitation. Lake levels (particularly Ontario and Superior) are also partially

controlled by regulatory works operated jointly by Canadian and U.S. authorities. These tend to minimize water level variations in those lakes. Six-month forecasts of lake levels are published monthly by the Detroit District (Figure 2-1).

## 2-6. Design Wave Estimation

Wave heights and periods should be chosen to produce the most critical combination of forces on a structure with due consideration of the economic life, structural integrity, and hazard for events that may exceed the design conditions (see paragraph 2-4). Wave characteristics may be based on an analysis of wave gauge records, visual observations of wave action, published wave hindcasts, wave forecasts, or the maximum breaking wave at the site. Wave characteristics derived from such methods may be for deepwater locations and must be transformed to the structure site using refraction and diffraction techniques as described in the SPM. Wave analyses may have to be performed for extreme high and low design water levels and for one or more intermediate levels to determine the critical design conditions.

## 2-7. Wave Height and Period Variability and Significant Waves

### a. Wave height.

(1) A given wave train contains individual waves of varying height and period. The significant wave height,  $H_s$ , is defined as the average height of the highest one-third of all the waves in a wave train. Other wave heights such as  $H_{10}$  and  $H_1$  can also be designated, where  $H_{10}$  is the average of the highest 10 percent of all waves, and  $H_1$  is the average of the highest 1 percent of all waves. By assuming a Rayleigh distribution, it can be stated that

$$H_{10} \approx 1.27 H_s \quad (2-1)$$

and

$$H_1 \approx 1.67 H_s \quad (2-2)$$

(2) Available wave information is frequently given as the energy-based height of the zeroth moment,  $H_{mo}$ . In deep water,  $H_s$  and  $H_{mo}$  are about equal; however, they may be significantly different in shallow water due to shoaling (Thompson and Vincent 1985). The following equation may be used to equate  $H_s$  from energy-based wave parameters (Hughes and Borgman 1987):

$$\frac{H_s}{H_{mo}} = \exp \left[ C_0 \left( \frac{d}{g T_p^2} \right)^{C_1} \right] \quad (2-3)$$

where

$C_0, C_1$  = regression coefficients given as 0.00089 and 0.834, respectively

$d$  = water depth at point in question (i.e., toe of structure)

$g$  = acceleration of gravity

$T_p$  = period of peak energy density of the wave spectrum

A conservative value of  $H_s$  may be obtained by using 0.00136 for  $C_0$ , which gives a reasonable upper envelope for the data in Hughes and Borgman. Equation 2-3 should not be used for

$$\frac{d}{g T_p^2} < 0.0005 \quad (2-4)$$

or where there is substantial wave breaking.

(3) In shallow water,  $H_s$  is estimated from deepwater conditions using the irregular wave shoaling and breaking model of Goda (1975, 1985) which is available as part of the Automated Coastal Engineering System (ACES) package (Leenknecht et al. 1989). Goda (1985) recommends for the design of rubble structures that if the depth is less than one-half the deepwater significant wave height, then design should be based on the significant wave height at a depth equal to one-half the significant deepwater wave height.

b. *Wave period.* Wave period for spectral wave conditions is typically given as period of the peak energy density of the spectrum,  $T_p$ . However, it is not uncommon to find references and design formulae based on the average wave period ( $T_z$ ) or the significant wave period ( $T_s$ , average period of the one-third highest waves). Rough guidance on the relationship among these wave periods is given in Table 2.1.

c. *Stability considerations.* The wave height to be used for stability considerations depends on whether the

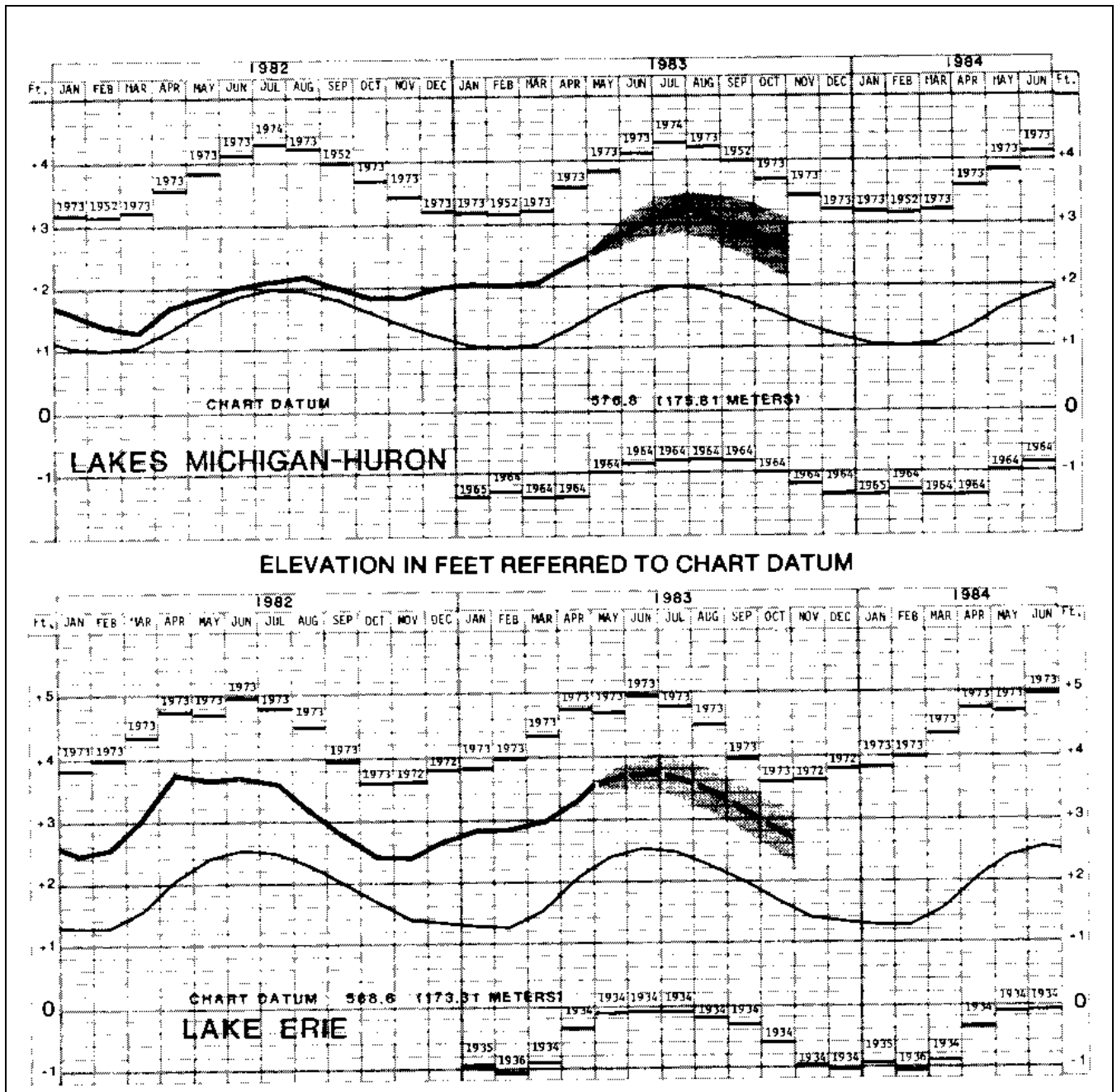

Figure 2-1. Monthly lake level forecast

structure is rigid, semirigid, or flexible. Rigid structures that could fail catastrophically if overstressed may warrant design based on  $H_1$ . Semirigid structures may warrant a design wave between  $H_1$  and  $H_{10}$ . Flexible structures are usually designed for  $H_s$  or  $H_{10}$ . Stability coefficients are coupled with these wave heights to develop various degrees of damage, including no damage.

## 2-8. Wave Gauges and Visual Observations

Available wave data for use by designers is often sparse and limited to specific sites. In addition, existing gauge data are sometimes analog records which have not been analyzed and that are difficult to process. Project funding

**Table 2-1**  
**Relationships among  $T_p$ ,  $T_s$ , and  $T_z$**

$T_z/T_p$	$T_s/T_p$	Comments	$\gamma$
0.67	0.80	Severe surf zone conditions <sup>1</sup>	NA
0.74	0.88	Pierson-Moskowitz spectrum <sup>2</sup>	1.0
0.80	0.93	Typical JONSWAP spectrum <sup>2</sup>	3.3
0.87	0.96	Swell from distant storms <sup>2</sup>	10.0

<sup>1</sup> Developed from data in Ahrens (1987).

<sup>2</sup> Developed from Goda (1987).

and time constraints may prohibit the establishment of a viable gauging program that would provide sufficient digital data for reliable study. Visual observations from shoreline points are convenient and inexpensive, but they have questionable accuracy, are often skewed by the omission of extreme events, and are sometimes difficult to extrapolate to other sites along the coast. A visual wave observation program is described in Schneider (1981). Problems with shipboard observations are similar to shore observations.

## 2-9. Wave Hindcasts

Designers should use the simple hindcasting methods in ACES (Leenknecht et al. 1989) and hindcasts developed by the U.S. Army Engineer Waterways Experiment Station (WES) (Resio and Vincent 1976-1978; Corson et al. 1981) for U.S. coastal waters using numerical models. These later results are presented in a series of tables for each of the U.S. coasts. They give wave heights and periods as a function of season, direction of wave approach, and return period; wave height as a function of return period and seasons combined; and wave period as a function of wave height and approach angle. Several other models exist for either shallow or deep water. Specific applications depend on available wind data as well as bathymetry and topography. Engineers should stay abreast of developments and choose the best method for a given analysis. Contact the Coastal Engineering Research Center (CERC) at WES for guidance in special cases.

## 2-10. Wave Forecasts

Wave forecasts can be performed using the same methodologies as those for the wave hindcasts. Normally, the Corps hindcasts waves for project design, and the Navy forecasts waves to plan naval operations.

## 2-11. Breaking Waves

*a.* Wave heights derived from a hindcast should be checked against the maximum breaking wave that can be supported at the site given the available depth at the design still-water level and the nearshore bottom slope. Figure 2-2 (Weggel 1972) gives the maximum breaker height,  $H_b$ , as a function of the depth at the structure,  $d_s$ , nearshore bottom slope,  $m$ , and wave period,  $T$ . Design wave heights, therefore, will be the *smaller* of the maximum breaker height or the hindcast wave height.

*b.* For the severe conditions commonly used for design,  $H_{mo}$  may be limited by breaking wave conditions. A reasonable upper bound for  $H_{mo}$  is given by

$$(H_{mo})_{\max} = 0.10 L_p \tanh\left(\frac{2\pi d}{L_p}\right) \quad (2-5)$$

where  $L_p$  is wavelength calculated using  $T_p$  and  $d$ .

## 2-12. Height of Protection

When selecting the height of protection, one must consider the maximum water level, any anticipated structure settlement, freeboard, and wave runup and overtopping.

## 2-13. Wave Runup

Runup is the vertical height above the still-water level (swl) to which the uprush from a wave will rise on a structure. Note that it is not the distance measured along the inclined surface.

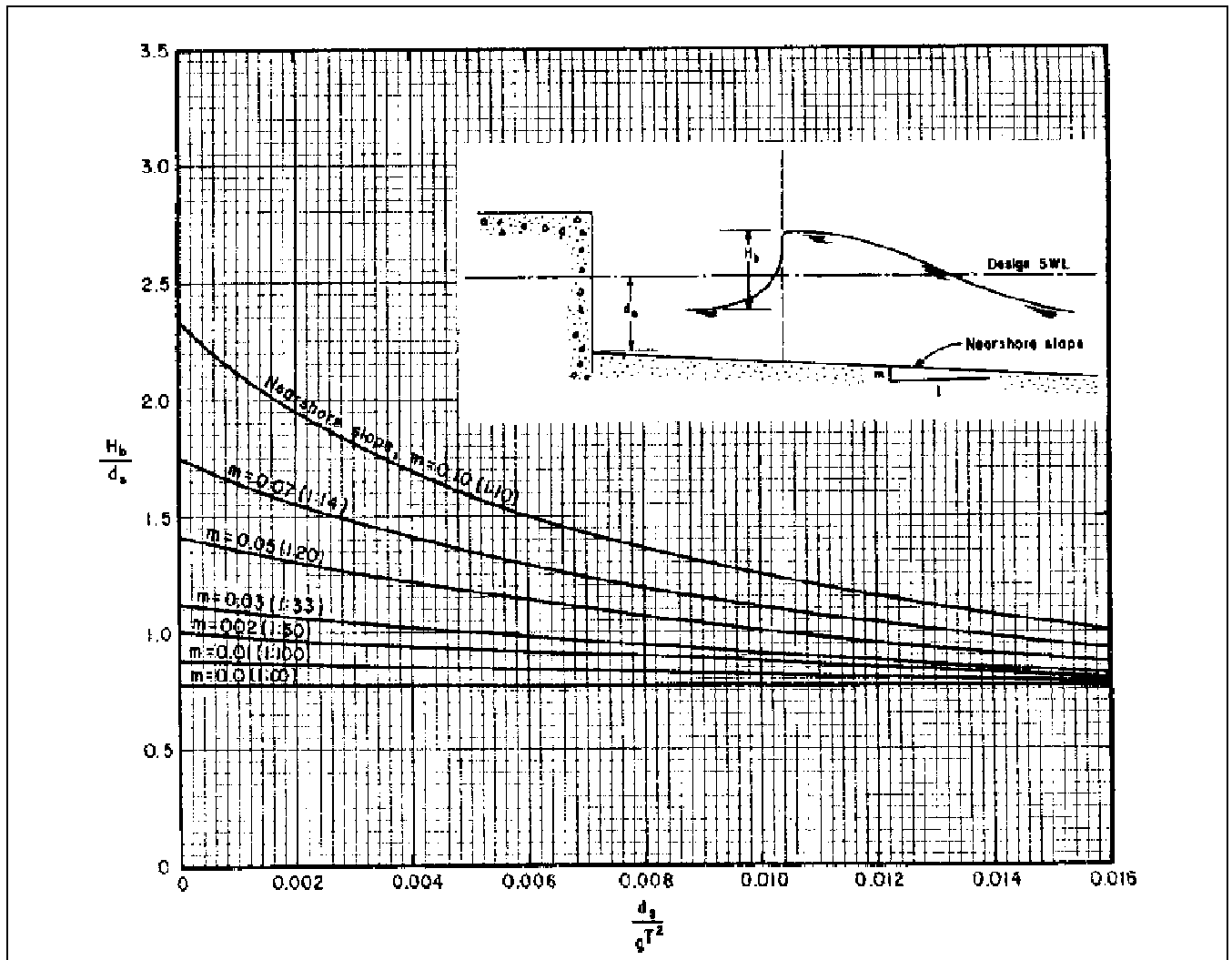

Figure 2-2. Design breaker height

a. Rough slope runup.

(1) Maximum runup by irregular waves on riprap-covered revetments may be estimated by (Ahrens and Heimbaugh 1988)

$$\frac{R_{\max}}{H_{mo}} = \frac{a\xi}{1 + b\xi} \quad (2-6)$$

where

$R_{\max}$  = maximum vertical height of the runup above the swl

$a, b$  = regression coefficients determined as 1.022 and 0.247, respectively

$\xi$  = surf parameter defined by

$$\xi = \frac{\tan \theta}{\left(\frac{2\pi H_{mo}}{gT_p^2}\right)^{1/2}} \quad (2-7)$$

where  $\theta$  is the angle of the revetment slope with the horizontal. Recalling that the deepwater wavelength may be determined by

$$L_o = \frac{gT_p^2}{2\pi} \quad (2-8)$$

the surf parameter is seen to be the ratio of revetment slope to square root of wave steepness. The surf parameter is useful in defining the type of breaking wave conditions expected on the structure, as shown in Figure 2-3.

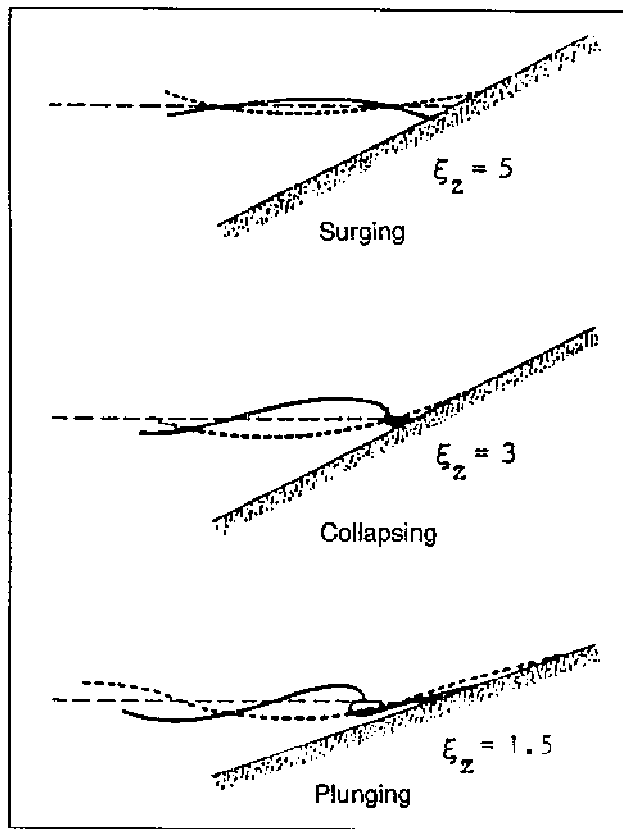

Figure 2-3. Surf parameter and breaking wave types

(2) A more conservative value for  $R_{\max}$  is obtained by using 1.286 for  $a$  in Equation 2-6. Maximum runups determined using this more conservative value for  $a$  provide a reasonable upper limit to the data from which the equation was developed.

(3) Runup estimates for revetments covered with materials other than riprap may be obtained with the rough slope correction factors in Table 2-2. Table 2-2 was developed for earlier estimates of runup based on monochromatic wave data and smooth slopes. To use the correction factors in Table 2-2 with the irregular wave rough slope runup estimates of Equation 2-6, multiply

$R_{\max}$  in Equation 2-6 by the correction factor listed in Table 2-2, and divide by the correction factor for quarrystone. For example, to estimate  $R_{\max}$  for a stepped 1:1.5 slope with vertical risers, determine  $R_{\max}$  by Equation 2-6 and multiply by (correction factor for stepped slope/correction factor for quarrystone)  $(0.75/0.60) = 1.25$ .  $R_{\max}$  for the stepped slope is seen to be 25 percent greater than for a riprap slope.

*b. Smooth slope runup.* Runup values for smooth slopes may be found in design curves in the SPM. However, the smooth slope runup curves in the SPM were based on monochromatic wave tests rather than more realistic irregular wave conditions. Using  $H_s$  for wave height with the design curves will yield runup estimates that may be exceeded by as much as 50 percent by waves in the wave train with heights greater than  $H_s$ . Maximum runup may be estimated by using Equation 2-6 and converting the estimate to smooth slope by dividing the result by the quarrystone rough slope correction factor in Table 2-2.

*c. Runup on walls.* Runup determinations for vertical and curved-face walls should be made using the guidance given in the SPM.

## 2-14. Wave Overtopping

*a.* It is generally preferable to design shore protection structures to be high enough to preclude overtopping. In some cases, however, prohibitive costs or other considerations may dictate lower structures than ideally needed. In those cases it may be necessary to estimate the volume of water per unit time that may overtop the structure.

*b.* Wave overtopping of riprap revetments may be estimated from the dimensionless equation (Ward 1992)

$$Q' = C_0 e^{C_1 F'} e^{C_2 m} \quad (2-9)$$

where  $Q'$  is dimensionless overtopping defined as

$$Q' = \frac{Q}{(gH_{mo}^3)^{1/2}} \quad (2-10)$$

where  $Q$  is dimensional overtopping in consistent units, such as cfs/ft.  $F'$  in Equation 2-9 is dimensionless freeboard defined as

**Table 2-2**  
**Rough Slope Runup Correction Factors (Carstea et al. 1975b)**

Armor Type	Slope (cot $\theta$ )	Relative Size $H / K_r^{a,b}$	Correction Factor $r$
Quarrystone	1.5	3 to 4	0.60
Quarrystone	2.5	3 to 4	0.63
Quarrystone	3.5	3 to 4	0.60
Quarrystone	5	3	0.60
Quarrystone	5	4	0.68
Quarrystone	5	5	0.72
Concrete Blocks <sup>c</sup>	Any	6 <sup>b</sup>	0.93
Stepped slope with vertical risers	1.5	$1 \leq H_o'/K_r^d$	0.75
Stepped slope with vertical risers	2.0	$1 \leq H_o'/K_r^d$	0.75
Stepped slope with vertical risers	3.0	$1 \leq H_o'/K_r^d$	0.70
Stepped slope with rounded edges	3.0	$1 \leq H_o'/K_r^d$	0.86
Concrete Armor Units			
Tetrapods random two layers	1.3 to 3.0	-	0.45
Tetrapods uniform two layers	1.3 to 3.0	-	0.51
Tribars random two layers	1.3 to 3.0	-	0.45
Tribars uniform one layer	1.3 to 3.0	-	0.50

<sup>a</sup>  $K_r$  is the characteristic height of the armor unit perpendicular to the slope. For quarrystone, it is the nominal diameter; for armor units, the height above the slope.

<sup>b</sup> Use  $H_o'$  for  $d_j/H_o' > 3$ ; and the local wave height,  $H_s$  for  $d_j/H_o' \leq 3$ .

<sup>c</sup> Perforated surfaces of Gobi Blocks, Monoslaps, and concrete masonry units placed hollows up.

<sup>d</sup>  $K_r$  is the riser height.

$$F' = \frac{F}{(H_{mo}^2 L_o)^{1/3}} \quad (2-11)$$

where  $F$  is dimensional freeboard (vertical distance of crest above swl). The remaining terms in Equation 2-9 are  $m$  (cotangent of revetment slope) and the regression coefficients  $C_0$ ,  $C_1$ , and  $C_2$  defined as

$$\begin{aligned} C_0 &= 0.4578 \\ C_1 &= -29.45 \\ C_2 &= 0.8464 \end{aligned} \quad (2-12)$$

The coefficients listed above were determined for dimensionless freeboards in the range  $0.25 < F' < 0.43$ , and revetment slopes of 1:2 and 1:3.5.

c. Overtopping rates for seawalls are complicated by the numerous shapes found on the seawall face plus the

variety of fronting berms, revetments, and steps. Information on overtopping rates for a range of configurations is available in Ward and Ahrens (1992). For bulkheads and simple vertical seawalls with no fronting revetment and a small parapet at the crest, the overtopping rate may be calculated from

$$Q' = C_0 \exp \left[ C_1 F' + C_2 \left( \frac{F}{d_s} \right) \right] \quad (2-13)$$

where  $Q'$  is defined in Equation 2-10,  $F'$  is defined in Equation 2-11,  $d_s$  is depth at structure toe, and the regression coefficients are defined by

$$\begin{aligned} C_0 &= 0.338 \\ C_1 &= -7.385 \\ C_2 &= -2.178 \end{aligned} \quad (2-14)$$



For other configurations of seawalls, Ward and Ahrens (1992) should be consulted, or physical model tests should be performed.

## 2-15. Stability and Flexibility

Structures can be built by using large monolithic masses that resist wave forces or by using aggregations of smaller units that are placed either in a random or in a well-ordered array. Examples of these are large reinforced concrete seawalls, quarrystone or riprap revetments, and geometric concrete block revetments. The massive monoliths and interlocking blocks often exhibit superior initial strength but, lacking flexibility, may not accommodate small amounts of differential settlement or toe scour that may lead to premature failure. Randomly placed rock or concrete armor units, on the other hand, experience settlement and readjustment under wave attack, and, up to a point, have reserve strength over design conditions. They typically do not fail catastrophically if minor damages are inflicted. The equations in this chapter are suitable for preliminary design for major structures. However, final design will usually require verification of stability and performance by hydraulic model studies. The design guidance herein may be used for final design for small structures where the consequences of failure are minor. For those cases, project funds are usually too limited to permit model studies.

## 2-16. Armor Unit Stability

*a.* The most widely used measure of armor unit stability is that developed by Hudson (1961) which is given in Equation 2-15:

$$W = \frac{\gamma_r H^3}{K_D \left( \frac{\gamma_r}{\gamma_w} - 1 \right)^3 \cot \theta} \quad (2-15)$$

where

$W$  = required individual armor unit weight, lb (or  $W_{50}$  for graded riprap)

$\gamma_r$  = specific weight of the armor unit, lb/ft<sup>3</sup>

$H$  = monochromatic wave height

$K_D$  = stability coefficient given in Table 2-3

$\gamma_w$  = specific weight of water at the site (salt or fresh)

$\theta$  = is structure slope (from the horizontal)

Stones within the cover layer can range from 0.75 to 1.25  $W$  as long as 50 percent weigh at least  $W$  and the gradation is uniform across the structure's surface. Equation 2-15 can be used for preliminary and final design when  $H$  is less than 5 ft and there is no major overtopping of the structure. For larger wave heights, model tests are preferable to develop the optimum design. Armor weights determined with Equation 2-15 for monochromatic waves should be verified during model tests using spectral wave conditions.

*b.* Equation 2-15 is frequently presented as a stability formula with  $N_s$  as a stability number. Rewriting Equation 2-15 as

$$N_s = \frac{H}{\left( \frac{W}{\gamma_r} \right)^{1/3} \left( \frac{\gamma_r}{\gamma_w} - 1 \right)} \quad (2-16)$$

it is readily seen that

$$N_s = (K_D \cot \theta)^{1/3} \quad (2-17)$$

By equating Equations 2-16 and 2-17,  $W$  is readily obtained.

*c.* For irregular wave conditions on revetments of dumped riprap, the recommended stability number is

$$N_{sz} = 1.14 \cot^{1/6} \theta \quad (2-18)$$

where  $N_{sz}$  is the zero-damage stability number, and the value 1.14 is obtained from Ahrens (1981b), which recommended a value of 1.45 and using  $H_s$  with Equation 2-16, then modified based on Broderick (1983), which found using  $H_{10}$  (10 percent wave height, or average of highest 10-percent of the waves) in Equation 2-16 provided a better fit to the data. Assuming a Rayleigh wave height distribution,  $H_{10} \approx 1.27 H_s$ . Because  $H_s$  is more readily available than  $H_{10}$ , the stability number in Equation 2-17 was adjusted ( $1.45/1.27 = 1.14$ ) to allow  $H_s$  to be used in the stability equation while providing the more conservative effect of using  $H_{10}$  for the design.

*d.* Stability equations derived from an extensive series of laboratory tests in The Netherlands were presented in van der Meer and Pilarczyk (1987) and van der

**Table 2-3**  
**Suggested Values for Use In Determining Armor Weight (Breaking Wave Conditions)**

Armor Unit	$n^1$	Placement	Slope (cot $\theta$ )	$K_D$
Quarrystone				
Smooth rounded	2	Random	1.5 to 3.0	1.2
Smooth rounded	>3	Random	1.5 to 3.0	1.6
Rough angular	1	Random	1.5 to 3.0	Do Not Use
Rough angular	2	Random	1.5 to 3.0	2.0
Rough angular	>3	Random	1.5 to 3.0	2.2
Rough angular	2	Special <sup>2</sup>	1.5 to 3.0	7.0 to 20.0
Graded riprap <sup>3</sup>	2 <sup>4</sup>	Random	2.0 to 6.0	2.2
Concrete Armor Units				
Tetrapod	2	Random	1.5 to 3.0	7.0
Tripod	2	Random	1.5 to 3.0	9.0
Tripod	1	Uniform	1.5 to 3.0	12.0
Dolos	2	Random	2.0 to 3.0 <sup>5</sup>	15.0 <sup>6</sup>

<sup>1</sup>  $n$  equals the number of equivalent spherical diameters corresponding to the median stone weight that would fit within the layer thickness.

<sup>2</sup> Special placement with long axes of stone placed perpendicular to the slope face. Model tests are described in Markle and Davidson (1979).

<sup>3</sup> Graded riprap is not recommended where wave heights exceed 5 ft.

<sup>4</sup> By definition, graded riprap thickness is two times the diameter of the minimum  $W_{50}$  size.

<sup>5</sup> Stability of dolosse on slope steeper than 1 on 2 should be verified by model tests.

<sup>6</sup> No damage design (3 to 5 percent of units move). If no rocking of armor (less than 2 percent) is desired, reduce  $K_D$  by approximately 50 percent.

Meer (1988a, 1988b). Two stability equations were presented. For plunging waves,

$$N_s = 6.2 P^{0.18} \left( \frac{S}{\sqrt{N}} \right)^{0.2} \xi_z^{0.5} \quad (2-19)$$

and for surging or nonbreaking waves,

$$N_s = 1.0 P^{-0.13} \left( \frac{S}{\sqrt{N}} \right)^{0.2} \sqrt{\cot \theta} \xi_z^P \quad (2-20)$$

where

$P$  = permeability coefficient

$S$  = damage level

$N$  = number of waves

$P$  varies from  $P = 0.1$  for a riprap revetment over an impermeable slope to  $P = 0.6$  for a mound of armor stone with no core. For the start of damage  $S = 2$  for revetment

slopes of 1:2 or 1:3, or  $S = 3$  for revetment slopes of 1:4 to 1:6. The number of waves is difficult to estimate, but Equations 2-19 and 2-20 are valid for  $N = 1,000$  to  $N = 7,000$ , so selecting 7,000 waves should provide a conservative estimate for stability. For structures other than riprap revetments, additional values of  $P$  and  $S$  are presented in van der Meer (1988a, 1988b).

*e.* Equations 2-19 and 2-20 were developed for deepwater wave conditions and do not include a wave-height truncation due to wave breaking. van der Meer therefore recommends a shallow water correction given as

$$N_{s \text{ (shallow water)}} = \frac{1.40 H_s}{H_2} \quad (2-21)$$

$$N_{s \text{ (deep water)}}$$

where  $H_2$  is the wave height exceeded by 2 percent of the waves. In deep water,  $H_2 \approx 1.40 H_s$ , and there is no correction in Equation 2-21.

## 2-17. Layer Thickness

*a. Armor units.* As indicated in the SPM, the thickness of an armor layer can be determined by Equation 2-22:

$$r = n k_{\Delta} \left( \frac{W}{w_r} \right)^{1/3} \quad (2-22)$$

where  $r$  is the layer thickness in feet,  $n$  is the number of armor units that would fit within the layer thickness (typically  $n=2$ ), and  $k_{\Delta}$  is the layer coefficient given in Table 2-4. For estimating purposes, the number of armor units,  $N_r$ , for a given surface area in square feet,  $A$ , is

$$N_r = A n k_{\Delta} \left( 1 - \frac{P}{100} \right) \left( \frac{w_r}{W} \right)^{2/3} \quad (2-23)$$

where  $P$  is the average porosity of the cover layer from Table 2-4.

*b. Graded riprap.* The layer thickness for graded riprap must be at least twice the nominal diameter of the  $W_{50}$  stone, where the nominal diameter is the cube root of the stone volume. In addition,  $r_{\min}$  should be at least 25 percent greater than the nominal diameter of the largest stone and should always be greater than a minimum layer thickness of 1 ft (Ahrens 1975). Therefore,

$$r_{\min} = \max \left[ \begin{array}{l} 2.0 \left( \frac{W_{50 \min}}{\gamma_r} \right)^{1/3}; \\ 1.25 \left( \frac{W_{100}}{\gamma_r} \right)^{1/3}; 1 \text{ ft} \end{array} \right] \quad (2-24)$$

where  $r_{\min}$  is the minimum layer thickness perpendicular to the slope. Greater layer thicknesses will tend to increase the reserve strength of the revetment against waves greater than the design. Gradation (within broad limits) appears to have little effect on stability provided the  $W_{50}$  size is used to characterize the layer. The following are suggested guidelines for establishing gradation limits (from EM 1110-2-1601) (see also Ahrens 1981a):

(1) The lower limit of  $W_{50}$  stone,  $W_{50 \min}$ , should be selected based on stability requirements using Equation 2-15.

(2) The upper limit of the  $W_{100}$  stone,  $W_{100 \max}$ , should equal the maximum size that can be economically obtained from the quarry but not exceed 4 times  $W_{50 \min}$ .

(3) The lower limit of the  $W_{100}$  stone,  $W_{100 \min}$ , should not be less than twice  $W_{50 \min}$ .

(4) The upper limit of the  $W_{50}$  stone,  $W_{50 \max}$ , should be about 1.5 times  $W_{50 \min}$ .

(5) The lower limit of the  $W_{15}$  stone,  $W_{15 \min}$ , should be about 0.4 times  $W_{50 \min}$ .

(6) The upper limit of the  $W_{15}$  stone,  $W_{15 \max}$ , should be selected based on filter requirements specified in EM 1110-2-1901. It should slightly exceed  $W_{50 \min}$ .

(7) The bulk volume of stone lighter than  $W_{15 \min}$  in a gradation should not exceed the volume of voids in the revetment without this lighter stone. In many cases, however, the actual quarry yield available will differ from the gradation limits specified above. In those cases the designer must exercise judgment as to the suitability of the supplied gradation. Primary consideration should be given to the  $W_{50 \min}$  size under those circumstances. For instance, broader than recommended gradations may be suitable if the supplied  $W_{50}$  is somewhat heavier than the required  $W_{50 \min}$ . Segregation becomes a major problem, however, when the riprap is too broadly graded.

## 2-18. Reserve Stability

*a. General.* A well-known quality of randomly placed rubble structures is the ability to adjust and resettle under wave conditions that cause minor damages. This has been called reserve strength or reserve stability. Structures built of regular or uniformly placed units such as concrete blocks commonly have little or no reserve stability and may fail rapidly if submitted to greater than design conditions.

*b. Armor units.* Values for the stability coefficient,  $K_D$ , given in paragraph 2-16 allow up to 5 percent damages under design wave conditions. Table 2-5 contains values of wave heights producing increasing levels of damage. The wave heights are referenced to the zero-damage wave height ( $H_{D=0}$ ) as used in Equation 2-15. Exposure of armor sized for  $H_{D=0}$  to these larger wave heights should produce damages in the range given. If the armor stone available at a site is lighter than the stone size calculated using the wave height at the site, the zero-damage wave height for the available stone can be

**Table 2-4**  
**Layer Coefficients and Porosity for Various Armor Units**

Armor Unit	$n$	Placement	$K_{\Delta}$	$P$ (%)
Quarrystone (smooth)	2	Random	1.00	38
Quarrystone (rough)	2	Random	1.00	37
Quarrystone (rough)	$\geq 3$	Random	1.00	40
Graded riprap	2 <sup>a</sup>	Random	N/A	37
Tetrapod	2	Random	1.04	50
Tribar	2	Random	1.02	54
Tribar	1	Uniform	1.13	47
Dolos	2	Random	0.94	56

<sup>a</sup> By definition, riprap thickness equals two cubic lengths of  $W_{50}$  or  $1.25 W_{100}$ .

**Table 2-5**  
 **$H/H_{D=0}$  for Cover Layer Damage Levels for Various Armor Types ( $H/H_{D=0}$  for Damage Level in Percent)**

Unit	$0 \leq \%_D < 5$	$5 \leq \%_D < 10$	$10 \leq \%_D < 15$	$15 \leq \%_D < 20$	$20 \leq \%_D \leq 30$
Quarrystone (smooth)	1.00	1.08	1.14	1.20	1.29
Quarrystone (angular)	1.00	1.08	1.19	1.27	1.37
Tetrapods	1.00	1.09	1.17	1.24	1.32
Tribars	1.00	1.11	1.25	1.36	1.50
Dolos	1.00	1.10	1.14	1.17	1.20

calculated, and a ratio with the site's wave height can be used to estimate the damage that can be expected with the available stone. All values in the table are for randomly placed units,  $n=2$ , and minor overtopping. The values in Table 2-5 are adapted from Table 7-8 of the SPM. The SPM values are for breakwater design and nonbreaking wave conditions and include damage levels above 30 percent. Due to differences in the form of damage to breakwaters and revetments, revetments may fail before damages reach 30 percent. The values should be used with caution for damage levels from breaking and non-breaking waves.

*c. Graded riprap.* Information on riprap reserve stability can be found in Ahrens (1981a). Reserve stability appears to be primarily related to the layer thickness although the median stone weight and structure slope are also important.

## 2-19. Toe Protection

*a. General.* Toe protection is supplemental armoring of the beach or bottom surface in front of a

structure which prevents waves from scouring and undercutting it. Factors that affect the severity of toe scour include wave breaking (when near the toe), wave runup and backwash, wave reflection, and grain-size distribution of the beach or bottom materials. The revetment toe often requires special consideration because it is subjected to both hydraulic forces and the changing profiles of the beach fronting the revetment. Toe stability is essential because failure of the toe will generally lead to failure throughout the entire structure. Specific guidance for toe design based on either prototype or model results has not been developed. Some empirical suggested guidance is contained in Eckert (1983).

### *b. Revetments.*

(1) Design procedure. Toe protection for revetments is generally governed by hydraulic criteria. Scour can be caused by waves, wave-induced currents, or tidal currents. For most revetments, waves and wave-induced currents will be most important. For submerged toe stone, weights can be predicted based on Equation 2-25:

$$W_{\min} = \frac{\gamma_r H^3}{N_s^3 \left( \frac{\gamma_r}{\gamma_w} - 1 \right)^3} \quad (2-25)$$

where  $N_s$  is the design stability number for rubble toe protection in front of a vertical wall, as indicated in the SPM (see Figure 2-7). For toe structures exposed to wave action, the designer must select either Equation 2-15 which applies at or near the water surface or Equation 2-25 above. It should be recognized that Equation 2-25 yields a minimum weight and Equation 2-15 yields a median weight. Stone selection should be based on the weight gradations developed from each of the stone weights. The relative importance of these factors depends on the location of the structure and its elevation with respect to low water. When the toe protection is for scour caused by tidal or riverine currents alone, the designer is referred to EM 1110-2-1601. Virtually no data exist on currents acting on toe stone when they are a product of storm waves and tidal or riverine flow. It is assumed that the scour effects are partially additive. In the case of a revetment toe, some conservatism is provided by using the design stability number for toe protection in front of a vertical wall as suggested above.

(2) Suggested toe configurations. Guidance contained in EM 1110-2-1601 which relates to toe design configurations for flood control channels is modified for coastal revetments and presented in Figure 2-4. This is offered solely to illustrate possible toe configurations. Other schemes known to be satisfactory by the designer are also acceptable. Designs I, II, IV, and V are for up to moderate toe scour conditions and construction in the dry. Designs III and VI can be used to reduce excavation when the stone in the toe trench is considered sacrificial and will be replaced after infrequent major events. A thickened toe similar to that in Design III can be used for underwater construction except that the toe stone is placed on the existing bottom rather than in an excavated trench.

*c. Seawalls and bulkheads.*

(1) General considerations. Design of toe protection for seawalls and bulkheads must consider geotechnical as well as hydraulic factors. Cantilevered, anchored, or gravity walls each depend on the soil in the toe area for their support. For cantilevered and anchored walls, this passive earth pressure zone must be maintained for stability against overturning. Gravity walls resist sliding through the frictional resistance developed between the soil and the base of the structure. Overturning is resisted

by the moment of its own weight supported by the zone of bearing beneath the toe of the structure. Possible toe configurations are shown in Figure 2-5.

(2) Seepage forces. The hydraulic gradients of seepage flows beneath vertical walls can significantly increase toe scour. Steep exit gradients reduce the net effective weight of the soil, making sediment movement under waves and currents more likely. This seepage flow may originate from general groundwater conditions, water derived from wave overtopping of the structure, or from precipitation. A quantitative treatment of these factors is presented in Richart and Schmertmann (1958).

(3) Toe apron width. The toe apron width will depend on geotechnical and hydraulic factors. The passive earth pressure zone must be protected for a sheet-pile wall as shown in Figure 2-6. The minimum width,  $B$ , from a geotechnical perspective can be derived using the Rankine theory as described in Eckert (1983). In these cases the toe apron should be wider than the product of the effective embedment depth and the coefficient of passive earth pressure for the soil. Using hydraulic considerations, the toe apron should be at least twice the incident wave height for sheet-pile walls and equal to the incident wave height for gravity walls. In addition, the apron should be at least 40 percent of the depth at the structure,  $d_s$ . Greatest width predicted by these geotechnical and hydraulic factors should be used for design. In all cases, undercutting and unraveling of the edge of the apron must be minimized.

(4) Toe stone weight. Toe stone weight can be predicted based on Figure 2-7 (from Brebner and Donnelly 1962)). A design wave between  $H_1$  and  $H_{10}$  is suggested. To apply the method assume a value of  $d_t$  the distance from the still water level to the top of the toe. If the resulting stone size and section geometry are not appropriate, a different  $d_t$  should be tried. Using the median stone weight determined by this method, the allowable gradation should be approximately 0.5 to 1.5  $W$ .

## 2-20. Filters

A filter is a transitional layer of gravel, small stone, or fabric placed between the underlying soil and the structure. The filter prevents the migration of the fine soil particles through voids in the structure, distributes the weight of the armor units to provide more uniform settlement, and permits relief of hydrostatic pressures within the soils. For areas above the waterline, filters also

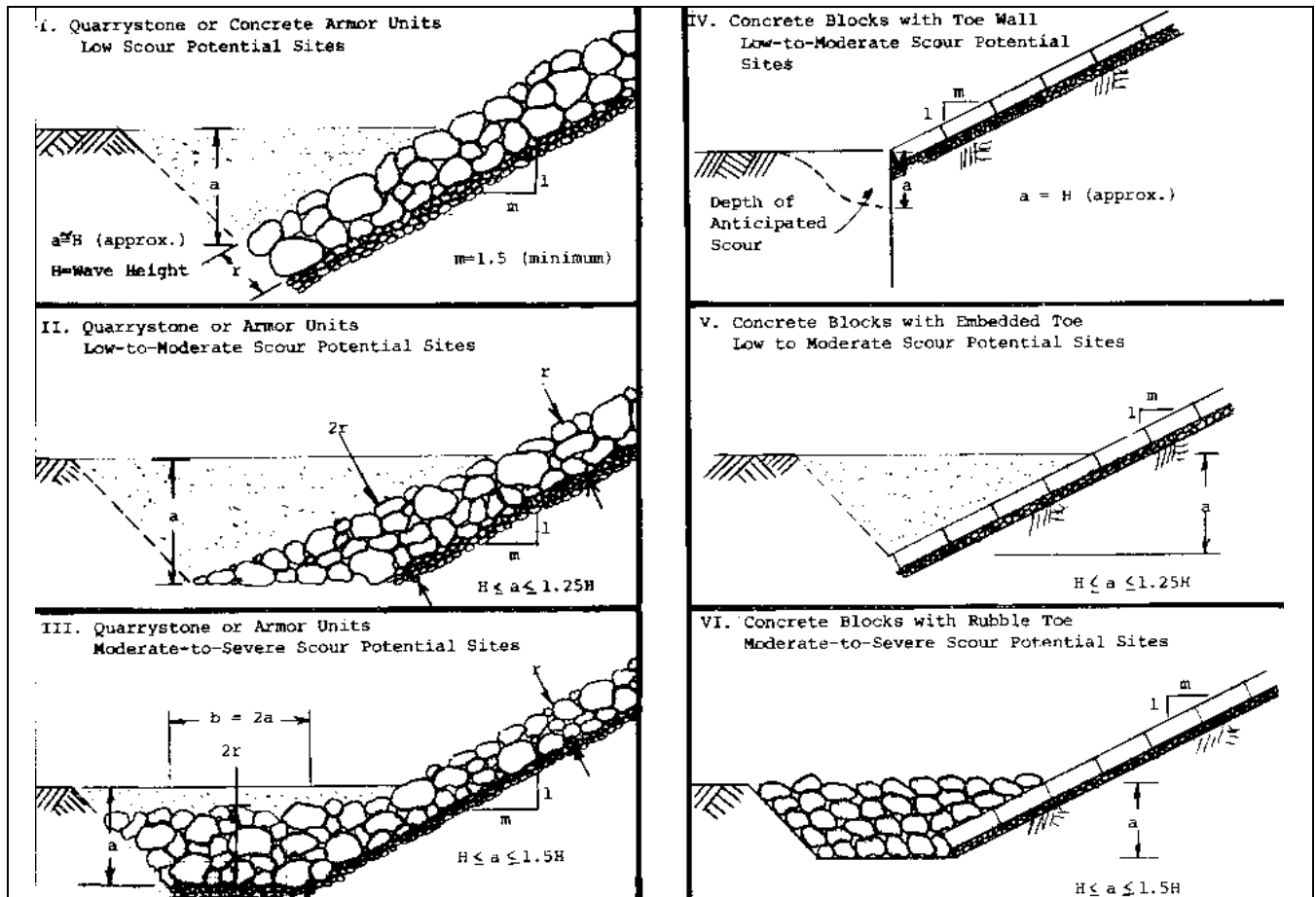

Figure 2-4. Revetment toe protection (Designs I through VI)

prevent surface water from causing erosion (gullies) beneath the riprap. In general form layers have the relation given in Equation 2-26:

$$\frac{d_{15\text{ upper}}}{d_{85\text{ under}}} < 4 \quad (2-26)$$

Specific design guidance for gravel and stone filters is contained in EM 1110-2-1901 and EM 1110-2-2300 (see also Ahrens 1981a), and guidance for cloth filters is contained in CW 02215. The requirements contained in these will be briefly summarized in the following paragraphs.

a. *Graded rock filters.* The filter criteria can be stated as:

$$\frac{d_{15\text{ filter}}}{d_{85\text{ soil}}} < 4 \text{ to } 5 < \frac{d_{15\text{ filter}}}{d_{15\text{ soil}}} \quad (2-27)$$

where the left side of Equation 2-27 is intended to prevent piping through the filter and the right side of Equation 2-27 provides for adequate permeability for structural bedding layers. This guidance also applies between successive layers of multilayered structures. Such designs are needed where a large disparity exists between the void size in the armor layer and the particle sizes in the underlying layer.

b. *Riprap and armor stone underlayers.* Underlayers for riprap revetments should be sized as in Equation 2-28,

$$\frac{d_{15\text{ armor}}}{d_{85\text{ filter}}} < 4 \quad (2-28)$$

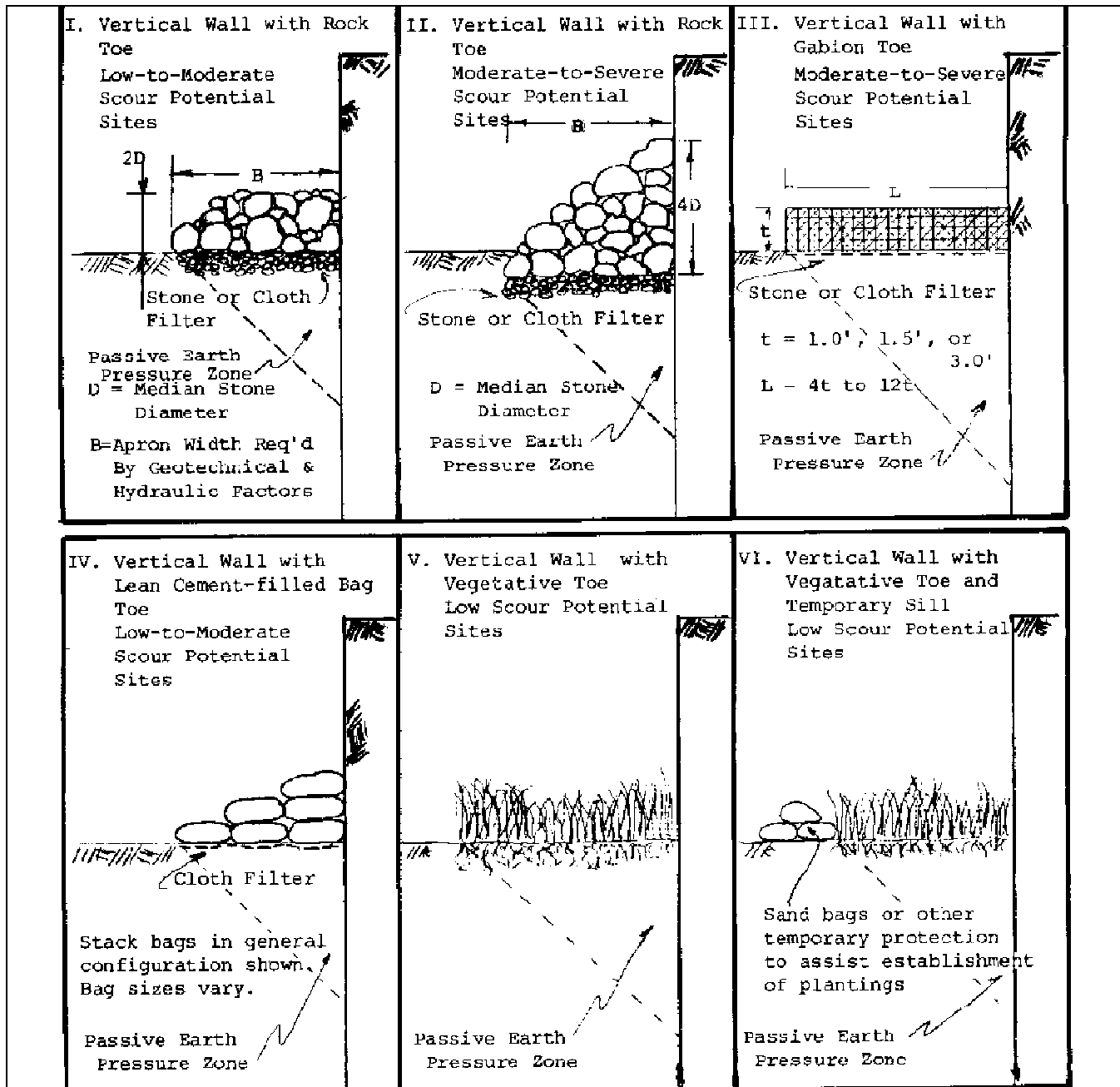

Figure 2-5. Seawall and bulkhead toe protection

where the stone diameter  $d$  can be related to the stone weight  $W$  through Equation 2-22 by setting  $n$  equal to 1.0. This is more restrictive than Equation 2-27 and provides an additional margin against variations in void sizes that may occur as the armor layer shifts under wave action. For large riprap sizes, each underlayer should meet the condition specified in Equation 2-28, and the layer thicknesses should be at least 3 median stone diameters.

For armor and underlayers of uniform-sized quarrystone, the first underlayer should be at least 2 stone diameters thick, and the individual units should weigh about one-tenth the units in the armor layer. When concrete armor units with  $K_D > 12$  are used, the underlayer should be quarrystone weighing about one-fifth of the overlying armor units.

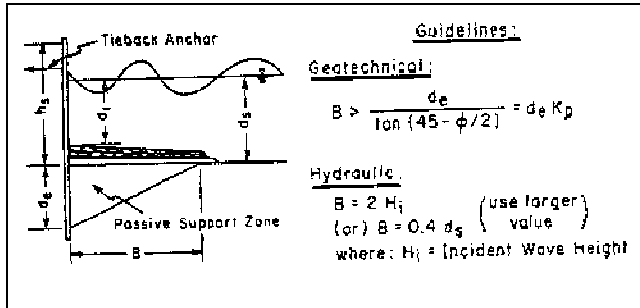

Figure 2-6. Toe aprons for sheet-pile bulkheads

c. *Plastic filter fabric selection.* Selection of filter cloth is based on the equivalent opening size (EOS), which is the number of the U.S. Standard Sieve having openings closest to the filter fabric openings. Material will first be retained on a sieve whose number is equal to the EOS. For granular soils with less than 50 percent fines (silts and clays) by weight (passing a No. 200 sieve), select the filter fabric by applying Equation 2-29:

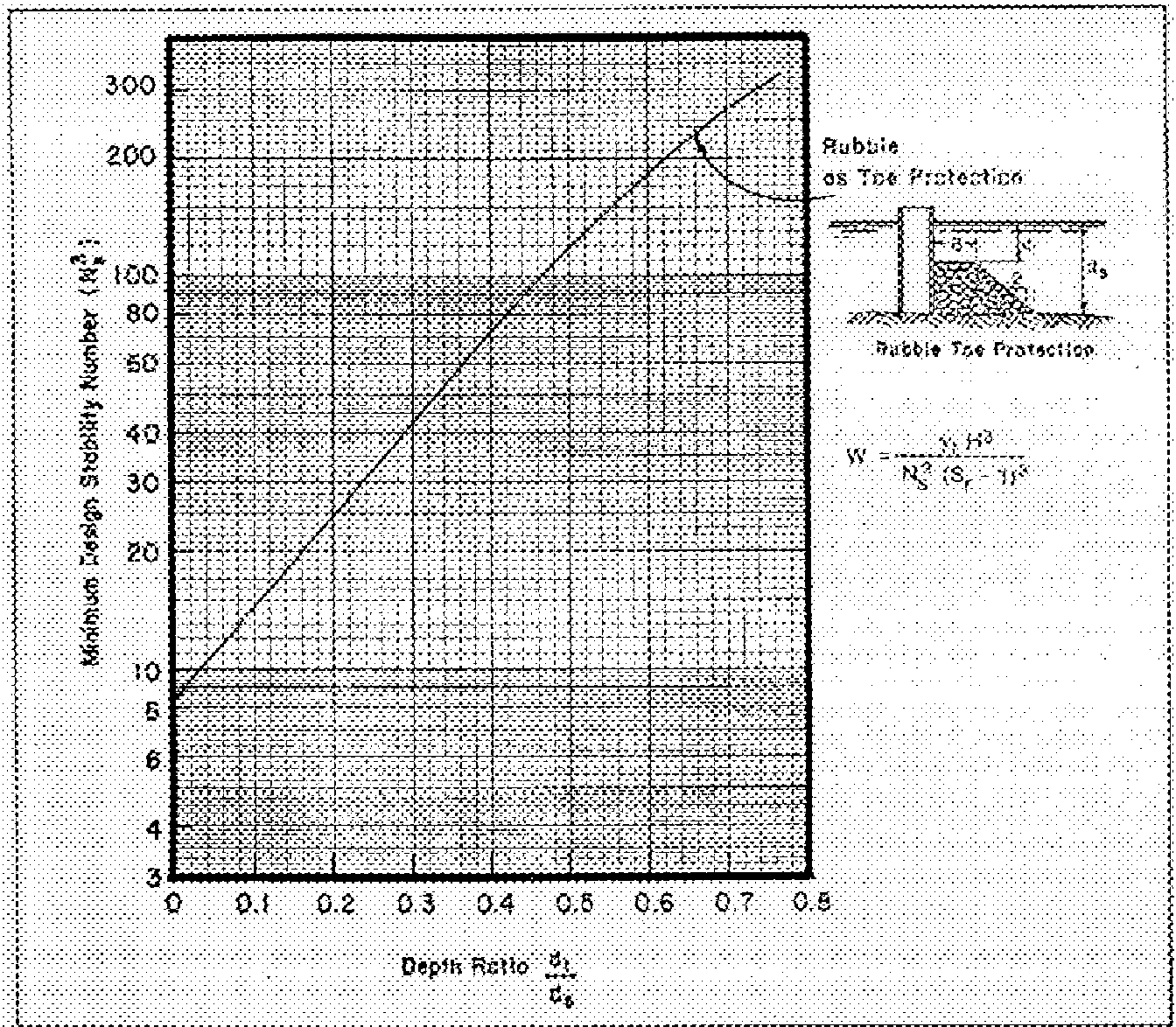

Figure 2-7. Value of  $N_s$ , toe protection design for vertical walls (from Brebner and Donnelly 1962)



$$\frac{EOS \text{ sieve}}{d_{85 \text{ soil}}} \leq 1 \quad (2-29)$$

For other soils, the EOS should be no larger than the openings in a No. 70 sieve. Furthermore, no fabric should be used whose EOS is greater than 100, and none should be used alone when the underlying soil contains more than 85 percent material passing a No. 200 sieve. In those cases, an intermediate sand layer may provide the necessary transition layer between the soil and the fabric. Finally, the gradient ratio of the filter fabric is limited to a maximum value of three. That is, based on a head permeability test, the hydraulic gradient through the fabric and the 1 in. of soil adjacent to the fabric ( $i_1$ ) divided by the hydraulic gradient of the 2 in. of soil between 1 and 3 in. above the fabric ( $i_2$ ) is:

$$\text{Gradient ratio} = \frac{i_1}{i_2} \leq 3 \quad (2-30)$$

Studies such as those in Chen et al. (1981) suggest that these filter cloth selection requirements may be somewhat restrictive.

*d. Filter fabric placement.* Experience indicates that synthetic cloths can retain their strength even after long periods of exposure to both salt and fresh water. To provide good performance, however, a properly selected cloth should be installed with due regard for the following precautions. First, heavy armor units may stretch the cloth as they settle, eventually causing bursting of the fabric in tension. A stone bedding layer beneath armor units weighing more than 1 ton for above-water work (1.5 tons for underwater construction) is suggested (Dunham and Barrett 1974), and multiple underlayers may be needed under primary units weighing more than 10 tons. Filter guidance must be properly applied in these cases. Second, the filter cloth should not extend seaward of the armor layer; rather, it should terminate a few feet landward of the armor layers as shown in Figure 2-8. Third, adequate overlaps between sheets must be provided. For lightweight revetments this can be as little as 12 in. and may increase to 3 ft for larger underwater structures. Fourth, sufficient folds should be included to eliminate tension and stretching under settlement. Securing pins with washers is also advisable at 2-to 5-ft intervals along the midpoint of the overlaps. Last, proper stone placement requires beginning at the toe and proceeding up

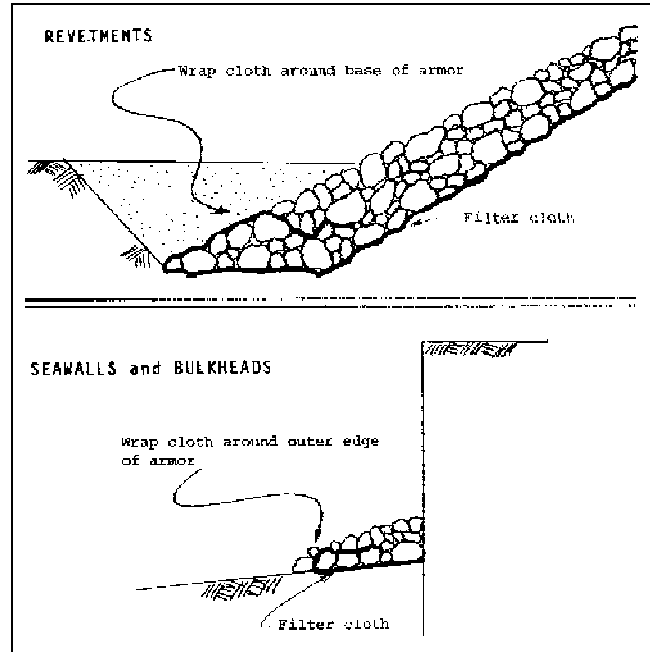

Figure 2-8. Use of filter cloth under revetment and toe protection stone

the slope. Dropping stone can rupture some fabrics even with free falls of only 1 ft, although Dunham and Barrett (1974) suggest that stones weighing up to 250 lb can safely be dropped from 3 ft. Greater drop heights are allowable under water where blocks up to 1 ton can be dropped through water columns of at least 5 ft.

## 2-21. Flank Protection

Flank protection is needed to limit vulnerability of a structure from the tendency for erosion to continue around its ends. Return sections are generally needed at both ends to prevent this. Sheet-pile structures can often be tied well into existing low banks, but the return sections of other devices such as rock revetments must usually be progressively lengthened as erosion continues. Extension of revetments past the point of active erosion should be considered but is often not feasible. In other cases, a thickened end section, similar to toe protection, can be used when the erosion rate is mild.

## 2-22. Corrosion

Corrosion is a primary problem with metals in brackish and salt water, particularly in the splash zone where materials are subjected to continuous wet-dry cycles. Mild carbon steel, for instance, will quickly corrode in such

conditions. Corrosion-resistant steel marketed under various trade names is useful for some applications. Aluminum sheetpiling can be substituted for steel in some places. Fasteners should be corrosion-resistant materials such as stainless or galvanized steel, wrought iron, or nylon. Various protective coatings such as coal-tar epoxy can be used to treat carbon steel. Care must always be taken to avoid contact of dissimilar metals (galvanic couples). The more active metal of a galvanic couple tends to act as an anode and suffers accelerated corrosion. The galvanic series of common metals in seawater is given in Table 2-6 (Uhlig 1971). This table can be used for estimating the corrosion potential of galvanic couples, but the complexity of corrosion processes makes it useful only as guide. For example, although aluminum and copper are

closer together on the table than aluminum and stainless steel, in actual practice polarization effects with stainless steel make it more compatible with aluminum than aluminum copper couples. The Construction Engineering Research Laboratory (CERL) should be contacted when either performance or longevity is a significant requirement.

### 2-23. Freeze-Thaw Cycles

Concrete should be designed for freeze-thaw resistance (as well as chemical reactions with salt water), as concrete may seriously degrade in the marine environment. Guidance on producing suitable high quality concrete is presented in EM 1110-2-2000 and Mather (1957).

**Table 2-6**  
**Galvanic Series in Sea Water**

	MATERIAL	MATERIAL ( $\approx$ ACTIVITY)
MORE	Magnesium	Stainless steel - 304 <sup>AS</sup>
	Stainless steel - 316 <sup>AS</sup>	
ACTIVE	Zinc	Lead
	Tin	
	Aluminum 52S4	
	Aluminum 4S	Magnesium bronze
	Aluminum 3S	Naval brass
	Aluminum 2S	
	Aluminum 53S-T	Nickel <sup>AS</sup>
	Yellow brass	
	Aluminum bronze	
	Red brass	
	Aluminum 17S-T	Copper, silicon bronze
	Aluminum 24S-T	
	Mild steel	Composition G bronze
	Wrought iron	Composition M bronze
	Cast iron	Nickel <sup>PS</sup>
LESS	Stainless steel-410 <sup>AS</sup>	
ACTIVE	Stainless steel-304 <sup>PS</sup>	
	Stainless steel-316 <sup>PS</sup>	

<sup>AS</sup> Active state  
<sup>PS</sup> Passive state

## 2-24. Marine Borer Activity

Timber used in marine construction must be protected against damage from marine borers through treatment with creosote and creosote coal-tar solutions or with water-borne preservative salts (CCA and ACA). In some cases, a dual treatment using both methods is necessary. Specific guidance is included in EM 1110-2-2906.

## 2-25. Ultraviolet Light

The ultraviolet component of sunlight quickly degrades untreated synthetic fibers such as those used for some filter cloths and sand-bags. Some fabrics can completely disintegrate in a matter of weeks if heavily exposed. Any fabric used in a shore protection project should be stabilized against ultraviolet light. Carbon black is a common stabilizing additive which gives the finished cloth a characteristic black or dark color in contrast to the white or light gray of unstabilized cloth. Even fabric that is covered by a structure should be stabilized since small cracks or openings can admit enough light to cause deterioration.

## 2-26. Abrasion

Abrasion occurs where waves move sediments back and forth across the faces of structures. Little can be done to prevent such damages beyond the use of durable rock or concrete as armoring in critical areas such as at the sand line on steel piles.

## 2-27. Vandalism and Theft

At sites where vandalism or theft may exist, construction materials must be chosen that cannot be easily cut, carried away, dismantled, or damaged. For instance, sand-filled fabric containers can be easily cut, small concrete blocks can be stolen, and wire gabions can be opened with wire cutters and the contents scattered.

## 2-28. Geotechnical Considerations

The stability of vertical bulkheads, particularly sheet-pile structures, requires consideration of overturning and stabilizing forces. Static forces include active soil and water pressures from the backfill, water and passive soil pressures on the seaward side, and anchor forces (when applicable). Dynamic forces are the result of wave action and seepage flow within the soil. Wave impacts increase soil pressure in the backfill and require larger resisting passive earth pressures and anchor forces to ensure stability. Seepage forces reduce passive pressures at the toe and tend to

decrease factors of safety. Toe scour decreases the effective embedment of the sheetpiling and threatens toe stability of the structure. This scouring action is caused by currents along the bottom and by pressure gradients. Both of these are induced by waves on the surface. A quantitative treatment of these geotechnical considerations can be found in Richart and Schmertmann (1958).

## 2-29. Wave Forces

Wave forces are determined for cases of nonbreaking, breaking, or broken waves. These cases are dependent on the wave height and depth at the structure. Wave forces for a range of possible water levels and wave periods should be computed.

*a. Nonbreaking waves.* Current design methods apply to vertical walls with perpendicularly approaching wave orthogonals. The Miche-Rundgren method as described in the SPM should be used. Curves are given in Chapter 7 of the SPM for walls with complete or nearly complete reflection. Complex face geometries cannot be handled, but methods are described which can be used in some cases to correct for low wall heights (where overtopping occurs), oblique wave attack on perpendicular structure faces, and walls on rubble bases.

*b. Breaking waves.* Breaking waves on vertical structures exert high, short-duration impulses that act in the region where the wave hits the structure. The method developed by Minikin as described in the SPM is recommended, particularly, for rigid structures such as sheet-pile structures or concrete gravity-type structures with pile supports. The Minikin method can yield extremely high wave forces compared to nonbreaking waves. This sometimes requires the exercise of proper judgment by the designer. Curves are given in the SPM to correct for low wall heights. For semirigid structures such as gravity-type seawalls on rubble foundations Equation 2-31 is recommended. Equation 2-31 was developed from Technical Standards for Port and Harbour Facilities in Japan (1980).

$$F = \frac{1}{2} \left[ d_s(P_1 + P_2) + h_c(P_1 + P_4) \right] \quad (2-31)$$

The total force,  $F$ , per unit length of the structure, includes both the hydrostatic and dynamic force components. Figure 2-9 illustrates the pressure distribution on the face of the structures due to the breaking waves. The key pressure components can be determined by:

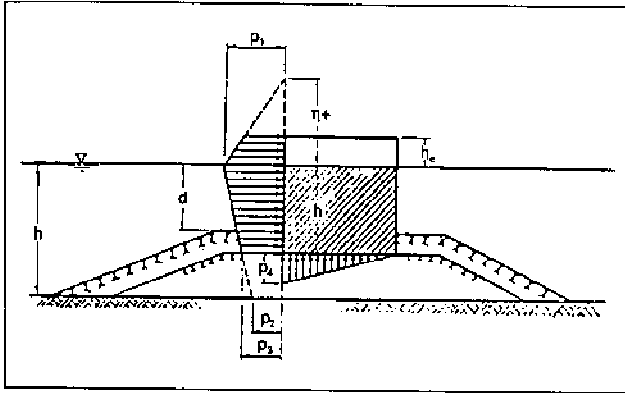

Figure 2-9. Breaking wave pressures on a vertical wall

$$P_1 = (\alpha_1 + \alpha_2) \gamma_w H_b \quad (2-32)$$

$$P_3 = \alpha_3 P_1 \quad (2-33)$$

$$P_4 = \left( 1 - \frac{h_c}{1.5 H_b} \right) P_1 \quad (2-34)$$

where

$$\alpha_1 = 0.6 + \frac{1}{2} \left[ \frac{4\pi h/L}{\sinh(4\pi h/L)} \right]^2 \quad (2-35)$$

$$\alpha_2 = \min \left[ \left( \frac{h_b - d}{3h_b} \right) \left( \frac{H_b}{d} \right)^2, \frac{2d}{H_b} \right] \quad (2-36)$$

$$\alpha_3 = 1 - \frac{d_s}{h} \left[ 1 - \frac{1}{\cosh \left( \frac{2\pi h}{L} \right)} \right] \quad (2-37)$$

where

$\gamma_w$  = specific weight of water

$h_c$  = height of crest of caisson above swl

$d$  = depth at top of rubble mound

$d_s$  = depth at base of caisson

$H_b$  = highest of the random waves breaking at a distance of  $5H_s$  seaward of the structure;  $H_s$  is the significant wave height of the design sea state

$h_b$  = water depth where  $H_b$  is determined

$h$  = water depth at toe of compound breakwater

$L$  = wave length calculated by linear wave theory at the structure for wave period of  $H_s$

As an example, for a vertical wall, 4.3 m (14 ft) high sited in sea water with  $d_s = 2.5$  m (8.2 ft) on a bottom slope of 1:20 ( $m = 0.05$ ) and experiencing wave crests at an interval of 10 sec, the force on the wall would be determined as follows:

Since there is no rubble-mound base, the water depth  $d_s = 2.5$  m. Using a wave period  $T = 10$  sec and Figure 7-4 of the SPM, the breaking wave height,  $H_b$ , is found to be 3.2 m (10.5 ft). Without knowledge of the significant wave height,  $H_s$ , the breaking depth,  $h_b$ , is determined directly by using SPM Figure 7-2, which yields  $h_b = 3.07$  m (10 ft). The wave breaks at a distance of 11.4 m (37 ft)  $[(3.07 - 2.5)/0.05]$  from the wall. Using SPM Appendix C Table C-1, wave length,  $L$ , at  $d_s = 2.5$  m is determined to be 48.7 m (160 ft). Then,  $\alpha_1$ ,  $\alpha_2$ , and  $\alpha_3$  are calculated to be 1.036, 0.101, and 0.950, respectively. Crest height,  $h_c$ , is less than  $1.5 H_b$  ( $1.8 < 4.8$ ) and overtopping exists. The pressure components  $P_1$ ,  $P_3$ , and  $P_4$  are computed from the above equations to be  $36.4 \text{ kN/m}^2$  ( $1,742.8 \text{ lb/ft}^2$ ),  $34.6 \text{ kN/m}^2$  ( $1656.6 \text{ lb/ft}^2$ ), and  $22.8 \text{ kN/m}^2$  ( $1,091.7 \text{ lb/ft}^2$ ), respectively. Equation 3-31 yields a total horizontal force due to the breaking wave of  $142 \text{ kN/m}^2$  ( $6,799 \text{ lb/ft}^2$ ).

*c. Broken waves.* Some structures are placed in a position where only broken waves can reach them. In those cases approximate broken wave force,  $F$ , per unit length of structure can be estimated (Camfield 1991) by Equation 2-38:

$$F = 0.18 \gamma H_b^2 \left( 1 - \frac{X_1 m}{R_A} \right)^2 \quad (2-38)$$

where  $\gamma$  is the specific weight of water and  $m$  is the beach slope ( $m = \tan \theta$ ). Other variables of Equation 2-38,  $H_b$ ,  $X_1$ , and  $R_A$  are defined in Figure 2-10. The adjusted

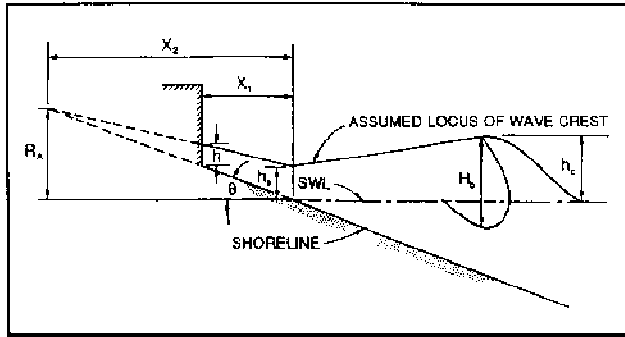

Figure 2-10. Wave pressure from broken waves

wave runup height,  $R_A$ , which would occur if the wall was not present can be determined by using Equation 2-6 (rough slopes) or following the methods described in Chapter 2-13 for smooth slopes or slopes covered with rubble other than quarrystone. If accurate force estimates are needed, model tests are required.

For example, deepwater waves are  $H_{mo} = 0.91$  m (3 ft) and  $T_p = 12$  sec. The waves cross 3.05 m (10 ft) of cobble shoreline with a slope of  $m = 0.10$  before impacting on a wall. From Figure 7-3 in SPM (1984), breaking wave height  $H_b$  is 2.05 m (6.75 ft). Using Equation 2-7 we find  $\xi = 1.57$ , and Equation 2-6 yields  $R_{max} = 1.36$  m (4.48 ft). Use  $R_{max}$  for the adjusted runup,  $R_A$ , in Equation 2-38 to find the force per unit length of wall is 4.58 kN/m length of wall (317 lb/ft length of wall).

### 2-30. Impact Forces

Impact forces constitute an important design consideration for shore structures because high winds can propel small pleasure craft, barges, and floating debris and cause great impact forces on a structure. If site or functional conditions require the inclusion of impact forces in the design, other measures should be taken to limit the depth of water against the face of the structure by providing a rubble-mound absorber against the face of the wall or a partly submerged sill seaward of the structure that will ground floating masses and eliminate the potential hazard. In many areas impact hazards may not occur, but where the potential exists (as for harbor structures), impact forces should be evaluated from impulse-momentum considerations.

### 2-31. Ice Forces

*a. General.* Ice can affect marine structures in a number of ways. Moving surface ice can cause significant crushing and bending forces as well as large

impact loadings. Vertical forces can be caused by the weight of ice on structures at low tide and by buoyant uplift at high tide of ice masses frozen to structural elements. EM 1110-2-1612 should be reviewed before designing any structure subject to ice forces.

*b. Damages.* Ice formations can cause considerable damage to shoreline at some points, but their net effects are largely beneficial. Spray “freezes” on banks and structures and covers them with a protective layer of ice. Ice piled on shore by wind and wave action does not generally cause serious damage to beaches, bulkheads, or protective riprap, but it provides additional protection against severe winter waves. Some abrasion of timber or concrete structures may be caused, and individual members may be broken or bent by the weight of the ice mass. Piling is sometimes slowly pulled by the repeated lifting effect of ice frozen to the piles or attached members, such as wales, and then it is forced upward by a rise in water stage or wave action. Superstructure damages also sometimes occur due to ice.

### 2-32. Hydraulic Model Tests

The guidance contained in this manual is suitable for preliminary design of all coastal structures and for final design of minor or inexpensive works where the consequences of failure are not serious. For most cases, however, the final design should be verified through a model testing program. Design deficiencies can be identified with such models, and design economics may be achieved which more than offset the cost of the study. Hudson et al. (1979) contains information on current hydraulic modeling techniques.

### 2-33. Two-Dimensional Models

Two-dimensional tests are conducted in wave tanks or flumes. Such tests are useful for evaluating toe stone and armor stability, wave runup heights, and overtopping potential. Generated waves may be either monochromatic or irregular depending on the capabilities of the equipment. Monochromatic waves represent the simplest case, and they form the basis for the majority of current design guidance. Irregular waves, on the other hand, are a closer representation of actual prototype conditions. Their use, however, adds to the complexity of a modeling program.

### 2-34. Three-Dimensional Models

Three-dimensional models are built in large shallow basins where processes such as wave refraction and diffraction are of interest. They can also lead to qualitative

results for sediment transport studies. However, these issues are generally unimportant for the design of revetments, seawalls, and bulkheads; therefore, the use of three-dimensional models would be unusual for such structures.

## 2-35. Previous Tests

WES has conducted a number of two- and three-dimensional model studies of site-specific projects. Details on five of these are given below. Units are given in prototype dimensions.

*a. Fort Fisher NC (1982).* Important features were (Markle 1982):

Scale	1:24
Waves	Heights of 5.5 to 17.2 ft Periods of 8, 10, and 12 sec
Depths	12, 14.7, 17, and 19 ft
Revetment slope:	1:2

The toe consisted of 8,919-lb StaPods on bedding stone. The sizes of the armor units were 5,900 lb (specially placed) and 8,900 lb (randomly placed). These were stable and undamaged in depths to 14.7 ft. At depths of 17 and 19 ft, considerable damages were experienced, but no failures occurred.

*b. El Morro Castle, San Juan, PR (1981).* Important features were (Markle 1981):

Scale	1:38.5
Waves	Heights of 10 to 23.3 ft Periods of 15 and 17 sec (north revetment)
	Heights of 2.5 to 10.5 ft Periods of 9, 15, and 17 sec (west revetment)
	18 and 19.9 ft (north revetment)
	13 and 14.9 ft (west revetment)

Revetment slope: 1:3

The toe protection was generally a 10-ft-wide armor stone blanket except in certain areas of the north revetment

where a low-crested breakwater was used. Armor stone sizes were 10,300 lb (west revetment), 24,530 lb (north revetment), and 9,360 lb (north revetment behind breakwater). All armor stone was randomly placed.

*c. Generalized harbor site for the U.S. Navy (1966).* Important features were (USAEWES 1966):

Scale	1:15
Waves	Heights of 5, 10, 15, and 20 ft 10-sec periods
Depths	20 to 40 ft
Revetment slope:	1:5

No toe protection was provided (the toe extended to the flume bottom). Stable rock sizes and values of  $K_d$  were reported for several wave conditions.

*d. Railroad fills at Ice Harbor and John Day Reservoirs (1962).* The tests were conducted for both riprap stability and runup. Important features were (USAEWES 1962):

Scale	1:12
Waves	Height of 2.4 to 2.6 ft Periods of 3, 4, 5, 6, and sec
Depths	20 to 40 ft
Revetment slope:	1:2

No toe protection was provided. The stable  $W_{50}$  sizes were

$W_{50}$	H
300 lb	3.0 to 3.4 ft
500 lb	2.0 to 4.1 ft
700 lb	3.9 to 4.9 ft

*e. Levees in Lake Okeechobee, FL (1957).* The tests were conducted for both wave runup and overtopping. Important features were (USAEWES 1957):

Scale	1:30 and 1:17
Waves	Heights of 4, 6, 8, and 12 ft Periods of 4.5 to 7 sec
Depths	10, 17.5, and 25 ft

**EM 1110-2-1614**  
**30 Jun 95**

Revetment slope: 1:3, 1:6, and  
composite slopes

No toe protection was considered. The tests produced a series of runup and overtopping volume curves.

## Chapter 3 Revetments

### 3-1. General

A revetment is a facing of erosion resistant material, such as stone or concrete, that is built to protect a scarp, embankment, or other shoreline feature against erosion. The major components of a revetment are the armor layer, filter, and toe (Figure 3-1). The armor layer provides the basic protection against wave action, while the filter layer supports the armor, provides for the passage of water through the structure, and prevents the underlying soil from being washed through the armor. Toe protection prevents displacement of the seaward edge of the revetment.

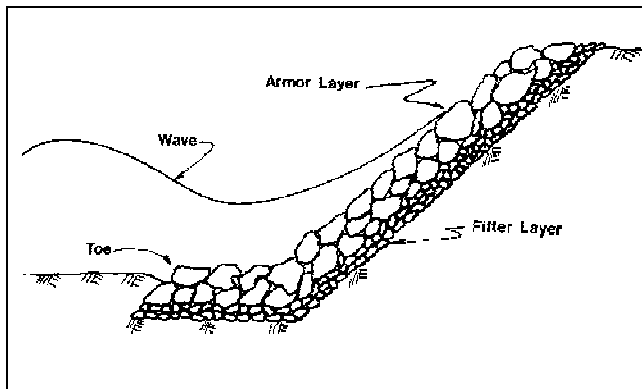

Figure 3-1. Typical revetment section

### 3-2. Armor Types

Revetment armoring may range from rigid to flexible types. Concrete slabs-on-grade is an example of the former, while riprap and quarrystone are examples of the latter. Rigid armors tend to be more massive but are generally unable to accommodate settlement or adjustments of the underlying materials. Flexible armor is constructed with lighter individual units that can tolerate varying amounts of displacement and shifting. Details of individual armor types are presented in Appendix B. The individual alternatives discussed in Appendix B are summarized in Figure 3-2.

### 3-3. Design Procedure Checklist

The usual steps needed to design an adequate revetment are:

- a. Determine the water level range for the site (paragraph 2-5).
- b. Determine the wave heights (paragraphs 2-6 to 2-11).
- c. Select suitable armor alternatives to resist the design wave (Appendix B).
- d. Select armor unit size (paragraphs 2-15 to 2-18).
- e. Determine potential runoff to set the crest elevation (paragraphs 2-12 and 2-13).
- f. Determine amount of overtopping expected for low structures (paragraph 2-14).
- g. Design underdrainage features if they are required.
- h. Provide for local surface runoff and overtopping runoff, and make any required provisions for other drainage facilities such as culverts and ditches.
- i. Consider end conditions to avoid failure due to flanking (paragraph 2-21).
- j. Design toe protection (paragraph 2-19).
- k. Design filter and underlayers (paragraph 2-20).
- l. Provide for firm compaction of all fill and back-fill materials. This requirement should be included on the plans and in the specifications. Also, due allowance for compaction must be made in the cost estimate.
- m. Develop cost estimate for each alternative.







<p>Quarystone Para. B-1</p>  <p>Uniform-sized armor stone or graded riprap Filter</p>	<p>Para. B-1</p>	<p>Large Rock Overlay Para. B-2</p>  <p>Large rock overlay Existing small armor stone</p>	<p>Para. B-2</p>
<p>Field Stone Para. B-3</p>  <p>Large, rounded field stone armor Filter</p>	<p>Para. B-3</p>	<p>Broken Concrete Para. B-4</p>  <p>Miscellaneous pieces of concrete rubble Filter</p>	<p>Para. B-4</p>
<p>Asphalt Para. B-5</p>  <p>Asphalt paving, rock-asphalt mastic or graded rock with patches of asphalt binder</p>	<p>Para. B-5</p>	<p>Concrete Armor Units Para. B-6</p>  <p>Randomly- or specially-placed armor units such as tribars, dolosse, etc. Underlayer Filter</p>	<p>Para. B-6</p>
<p>Concrete Para. B-7</p>  <p>Cast in place concrete slab on grade</p>	<p>Para. B-7</p>	<p>Concrete Revetment Blocks Para. B-8 to B-16</p>  <p>Concrete revetment blocks Filter</p>	<p>Para. B-8-16</p>
<p>Bags Para. B-18</p>  <p>Sand or concrete fill in fabric bags Filter</p>	<p>Para. B-18</p>	<p>Concrete-filled Mattress Para. B-19</p>  <p>Concrete-filled mattress</p>	<p>Para. B-19</p>
<p>Gabions Para. B-20</p>  <p>Rock-filled gabion baskets Filter</p>	<p>Para. B-20</p>	<p>Steel Fuel Barrels Para. B-21</p>  <p>Gravel-filled, 55-gallon steel fuel barrels</p>	<p>Para. B-21</p>
<p>Fabric Para. B-22</p>  <p>Filter cloth fabric Sand bags or other ballast</p>	<p>Para. B-22</p>	<p>Concrete Slabs Para. B-23</p>  <p>Concrete slabs from demolition work Filter</p>	<p>Para. B-23</p>
<p>Soil Cement Para. B-24</p>  <p>Multiple layers of compacted soil-cement</p>	<p>Para. B-24</p>	<p>Tire Mattress Para. B-25</p>  <p>Concrete-filled tires Filter</p>	<p>Para. B-25</p>
<p>Landing Mat Para. B-26</p>  <p>Anchor Filter Landing Mat</p>	<p>Para. B-26</p>	<p>Windrow Para. B-27</p>  <p>Stockpile (windrow) Rock launched from windrow as a result of erosion</p>	<p>Para. B-27</p>
<p>Vegetation Para. B-28</p>  <p>Beach and upland species above the intertidal zone Marsh species in the intertidal zone</p>	<p>Para. B-28</p>		

Figure 3-2. Summary of revetment alternatives

## Chapter 4 Seawalls

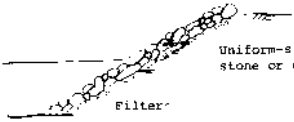
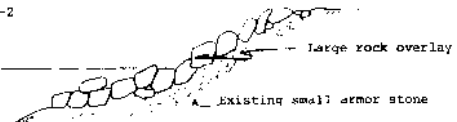
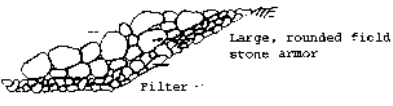
### 4-1. General

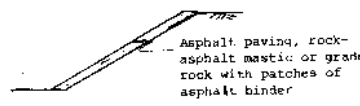
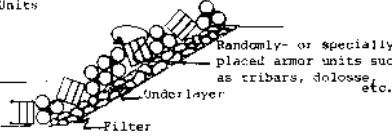
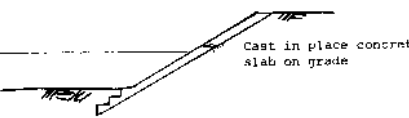
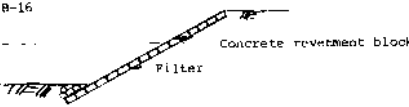
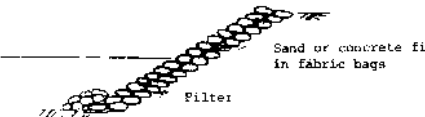
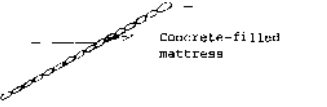
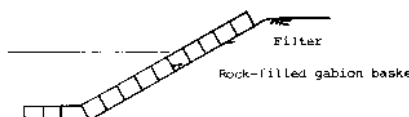
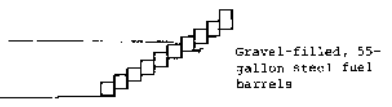
A seawall is a massive structure that is designed primarily to resist wave action along high value coastal property. Seawalls may be either gravity- or pile-supported structures. Common construction materials are either concrete or stone. Seawalls can have a variety of face shapes (Figure 4-1).

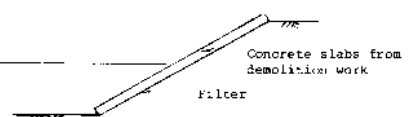
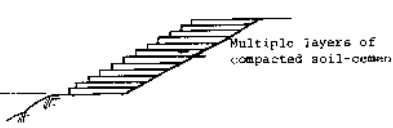
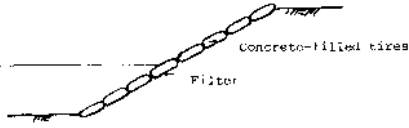
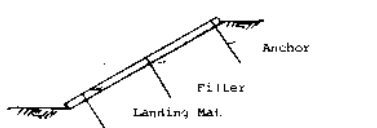
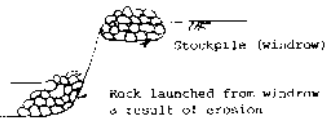
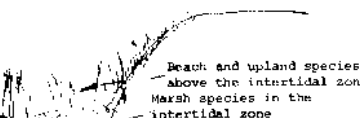
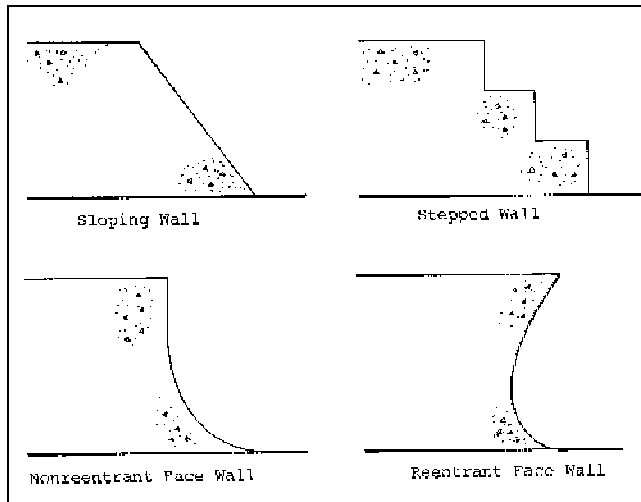

Figure 4-1. Typical concrete seawall sections

### 4-2. Concrete Seawalls

These structures are often pile-supported with sheetpile cutoff walls at the toe to prevent undermining. Additional rock toe protection may also be used. The seaward face may be stepped, vertical, or recurved. Typical examples are described in Appendix C and shown in Figure 4-2.

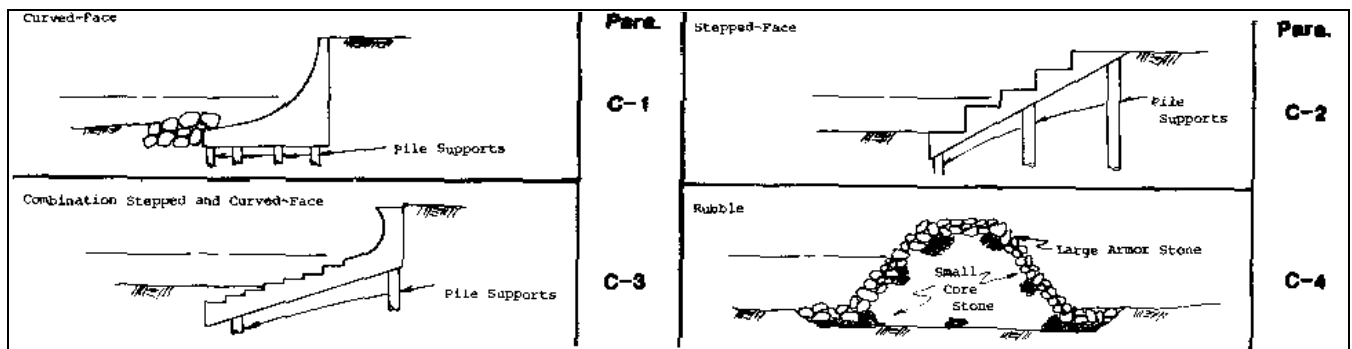

Figure 4.2. Summary of seawall alternatives

### 4-3. Rubble-Mound Seawalls

These are designed like breakwaters using a rock size that will be stable against the design wave. Stability is determined using the method described in paragraphs 2-15 to 2-18. An example is described in Appendix C and shown in Figure 4-2.

### 4-4. Design Procedure Checklist

The most critical design elements are a secure foundation to minimize settlement and toe protection to prevent undermining. Both of these are potential causes of failure of such walls. The usual steps needed to develop an adequate seawall design follow.

- a. Determine the water level range for the site (paragraph 2-5).
- b. Determine the wave heights (paragraphs 2-6 to 2-11).
- c. Select suitable seawall configurations (Appendix C).
- d. Design pile foundations using EM 1110-2-2906.
- e. Select a suitable armor unit type and size (rubble seawalls and toe protection) (paragraphs 2-15 to 2-18).
- f. Determine the potential runoff to set the crest elevation (paragraphs 2-12 to 2-13).
- g. Determine the amount of overtopping expected for low structures (paragraph 2-14).
- h. Design underdrainage features if they are required.

**EM 1110-2-1614**  
**30 Jun 95**

*i.* Provide for local surface runoff and overtopping and runoff, and make any required provisions for other drainage facilities such as culverts and ditches.

*j.* Consider end conditions to avoid failure due to flanking (paragraph 2-21).

*k.* Design the toe protection (paragraph 2-19).

*l.* Design the filter and underlayers (paragraph 2-20).

*m.* Provide for firm compaction of all fill and back-fill materials. This requirement should be included on the plans and in the specifications, and due allowance for compaction must be made in the cost estimate.

*n.* Develop cost estimate for each alternative.

## Chapter 5 Bulkheads

### 5-1. General

Bulkheads are retaining walls whose primary purpose is to hold or prevent the backfill from sliding while providing protection against light-to-moderate wave action. They are used to protect eroding bluffs by retaining soil at the toe, thereby increasing stability, or by protecting the toe from erosion and undercutting. They are also used for reclamation projects, where a fill is needed seaward of the existing shore, and for marinas and other structures where deep water is needed directly at the shore.

### 5-2. Structural Forms

Bulkheads are either cantilevered or anchored sheetpiling or gravity structures such as rock-filled timber cribbing. Cantilevers require adequate embedment for stability and are usually suitable where wall heights are low. Toe scour reduces their effective embedment and can lead to failure. Anchored bulkheads are usually used where

greater heights are necessary. Such bulkheads also require adequate embedment for stability but are less susceptible to failure due to toe scour. Gravity structures eliminate the expense of pile driving and can often be used where subsurface conditions hinder pile driving. These structures require strong foundation soils to adequately support their weight, and they normally do not sufficiently penetrate the soil to develop reliable passive resisting forces on the offshore side. Therefore, gravity structures depend primarily on shearing resistance along the base of the structure to support the applied loads. Gravity bulkheads also cannot prevent rotational slides in materials where the failure surface passes beneath the structure. Details of typical bulkheads are presented in Appendix D and are summarized in Figure 5-1.

### 5-3. Design Procedure Checklist

The bulkhead design procedure is similar to that presented for seawalls in paragraph 4-4, except that Appendix D is used for examples of typical bulkheads. In addition, toe protection should be designed using geotechnical and hydraulic conditions, including wave action and current scour.





<p>Sheet Piling</p> 	<p>Para. D-1 to D-5</p>	<p>Cellular Sheet Piling</p> 	<p>Para. D-6</p>
<p>Concrete Slabs and King-Pile</p> 	<p>D-8</p>	<p>Reinforced Ties and steel H-piles</p> 	<p>D-9</p>
<p>Treated Timber</p> 	<p>D-10</p>	<p>Untreated Logs</p> 	<p>D-11</p>
<p>Wegwire Fences and Sand Bags</p> 	<p>D-12</p>	<p>Used Tire and Timber Posts</p> 	<p>D-13</p>
<p>Timber Walls</p> 	<p>D-15</p>	<p>Stacked Rubber Tires</p> 	<p>D-16</p>
<p>Used Concrete Pipes</p> 	<p>D-17</p>	<p>Longard Tube</p> 	<p>D-18</p>
<p>Stacked Bag Bulkhead</p> 	<p>D-19</p>	<p>Gabions</p> 	<p>D-20</p>

Figure 5-1. Summary of bulkhead alternatives

## Chapter 6 Environmental Impacts

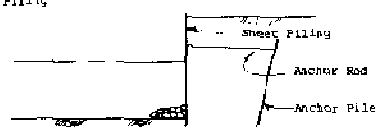
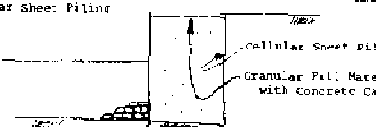
### 6-1. General

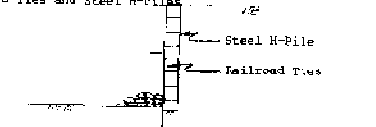
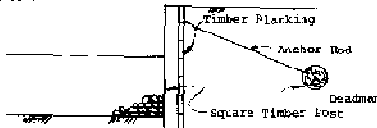
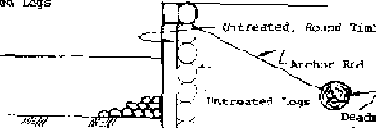
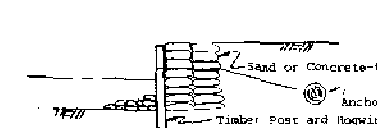
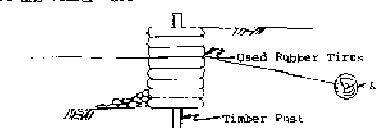
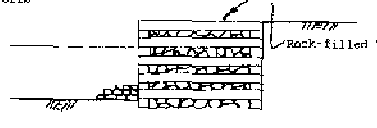
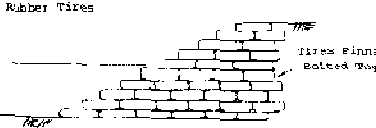
Coastal shore protection structures are intended to improve stability by reducing the rate of change in a dynamic coastal system. The environmental impacts may be short-term during construction operations or long-term because of the presence of the structures. The potential environmental impacts, which are similar for each of the coastal shore protection structures featured in this manual, are briefly discussed below. More detailed information may be found in Barnard (1978), Carstea et al. (1975a; 1975b), Ford et al. (1983), Hurme (1979), Johnson and DeWitt (1978), and Mulvihille et al. (1980).

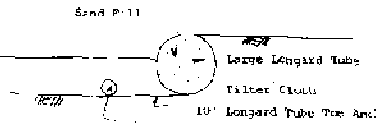
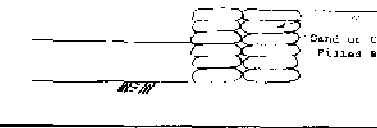
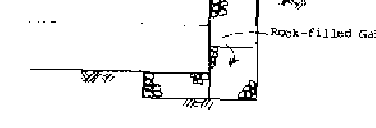
### 6-2. Physical Impacts

The littoral system at the site of a structure is always moving toward a state of dynamic equilibrium where the ability of waves, currents, and winds to move sediment is matched by the available supply of littoral materials. When there is a deficiency of material moving within a system, the tendency will be for erosion at some location to supply the required material. Once a structure has been built along a shoreline, the land behind it will no longer be vulnerable to erosion (assuming proper function of the structure), and the contribution of littoral material to the system will be diminished along the affected shoreline. The contribution formerly made by the area must now be supplied by the adjoining areas. This can have mixed environmental impacts. The reduction in sedimentation due to decreased erosion may be viewed as a positive effect in many cases. Erosion that is shifted to other areas may result in a negative impact in those locations. Some vertical structures such as bulkheads may cause increased wave reflection and turbulence with a subsequent loss of fronting beach. This is usually viewed as a negative impact. In all cases, the overall situation and the various impacts that result must be evaluated carefully to identify potential changes in the shore and barrier island processes.

### 6-3. Water Quality Impacts

Impacts of coastal shore protection structures on water quality can be addressed in two categories:

- a. Increased suspended solids during construction.
- b. Altered circulation caused by structures.

Construction of shore protection structures can result in increased suspended solid loads within the adjoining water body. Recent research results indicate that the traditional fears of water quality degradation caused from suspended solids during in-water construction activities are for the most part unfounded. It has been demonstrated that the increased concentration of suspended solids is generally confined to the immediate vicinity of the construction activity and dissipates rapidly at the completion of the operation. Although these are generally short-term impacts, construction activities should be designed to minimize generation of suspended solids. The dispersion of near-surface suspended solids can be controlled, to a certain extent, by placing a silt curtain around the construction activity. Under quiescent current conditions (less than 0.1 knot) the suspended solids level in the water column outside the curtain can be reduced by as much as 80 to 90 percent. Silt curtains are not recommended where currents exceed 1 knot. Steps must be taken also to avoid the introduction of toxic or other harmful substances resulting from construction materials, equipment leaks, spills, and other accidents. Project specifications should contain provisions that address these concerns. Structures may influence water quality by altering circulation patterns. Modification in circulation may result in changes in the spatial distribution of water quality constituents, differences in the flushing rates of potential contaminants, and changes in the scour patterns and deposition of sediments. Environmental assessment of the effects on circulation should initially emphasize the physical parameters such as salinity, temperature, and velocity. If minimal changes occur in these parameters, then it can be assumed that the chemical characteristics of the system will not be significantly modified. Prediction of changes in circulation and its effect on the physical parameters can be achieved through comparison with existing projects, physical model studies, and numerical simulation.

### 6-4. Biological Impacts

A wide variety of living resources is present in coastal shore protection project areas and includes species of commercial, recreational, and aesthetic importance. Because shore protection projects exist in arctic, temperate, and tropical climates, biological impacts will generally be highly site-specific and depend upon the nature and setting of the project. The environmental impacts on the benthic communities resulting from suspended solids in the water around shore protection construction are for the most part minor. This is particularly true in the surf zone on open coast beaches where rapid natural changes and disturbances are normal and where survival of the benthic community requires great adaptability. Placement

of coastal shore protection structures requires an initial disturbance of the benthic substrate, but it results in the formation of a new substrate composed of structural material and stability of the sediments adjacent to the structure. In many locations the placement of these structures provides new habitat not available otherwise.

### **6-5. Short-term Impacts**

Short-term impacts are usually associated with the actual construction phase of the project. The actual time is typically short (measured in days and weeks) and, therefore, can be scheduled to minimize negative impacts. Transportation of material to the site, preparation and construction using heavy equipment, and back filling and grading will cause temporary air and noise pollution close to the site. Nesting, resting, or feeding waterfowl and fish and other wildlife will be disrupted. Projects should be timed, if possible, to avoid waterfowl and turtle nesting periods and fish spawning periods. Temporarily reduced water quality, discussed in paragraph 6-3, may have biological impacts. However, if the bank is severely eroding or is heavily developed these impacts may be minimal by comparison. Siltation of offshore sea grasses or corals as the result of construction, dredging, and filling at the site may be of short or long duration depending on the composition of the sediment, the currents, and circulation patterns at the site and the locations of these specific resources. Construction impacts at sites with a high percentage of fine material and nearby sea grass bed or corals could be high and require special planning and precautions such as silt curtains. Dredging activities may attract opportunistic foraging fish as well as temporarily destroy benthic habitats. Resuspension of bottom sediments may interfere with respiration and feeding, particularly of nonmotile bottom dwellers. Motile organisms will temporarily flee the disturbed area.

### **6-6. Long-term Impacts**

Long-term effects vary considerably depending upon the location, design and material used in the structure. The impact of a vertical steel sheet bulkhead located at mean low water in a freshwater marsh will be considerably different from a rubble-reveted bank in an industrialized harbor. Vertical structures in particular may accelerate erosion of the foreshore and create unsuitable habitat for many bottom species in front of the structure as the result of increased turbulence and scour from reflected wave energy. On the other hand, rubble toe protection or a riprap revetment extending down into the water at a sloping angle will help dissipate wave energy and will provide reef habitat for many desirable species. Bulkheads and

revetments can reduce the area of the intertidal zone and eliminate the important beach or marsh habitat between the aquatic and upland environment. This can also result in the loss of spawning, nesting, breeding, feeding, and nursery habitat for some species. However, birds such as pelicans might benefit. A number of design alternatives should be considered to maximize biological benefits and minimize negative impacts. Table 6-1 summarizes design considerations for improving the environmental quality of these structures.

### **6-7. Socioeconomic and Cultural Impacts**

Secondary impacts are often more controversial than the primary impacts on air, water, noise, and the biota. Land use patterns will often change as the result of construction. However, only two elements normally are directly considered in the design of the structure itself. The structure should be sited to avoid known archaeological or other cultural sites. Secondly, the structure should be designed to be aesthetically pleasing. Coastal shore protection structures change the appearance of the coastline. The visual impact of a structure is dependent on how well the structure blends with its surroundings. The importance of visual impacts is related to the number of viewers, their frequency of viewing, and the overall context. For example, the appearance of a structure in a heavily used urban park is more critical than a structure in an industrial area or an isolated setting. Aesthetic impacts can be adverse or beneficial depending on preconstruction conditions and the perception of the individual observer. Coastal shore protection structures offer a visual contrast to the natural coastal environment. However, many observers prefer a structure to erosion damage. Most coastal shore protection structures improve access to the water's edge for recreation and sightseeing.

### **6-8. Evaluation of Alternatives**

Comparison and evaluation of coastal shore protection alternatives involves examination of economic, engineering, and environmental aspects. Alternatives are evaluated according to how well they meet specified project objectives. Examples of environmental objectives include preservation, protection, and enhancement of aesthetic resources, fish and wildlife habitat, and water quality. Evaluation of the short- and long-term impacts of coastal shore protection structures requires comparison of with-project and without-project conditions. Recognizing the dynamic nature of the coastal system, a forecast must be made of future environmental conditions without the project. These predicted conditions are then compared

**Table 6-1  
Environmental Design Considerations for Revetments, Seawalls, and Bulkheads**

Factor	Design Considerations <sup>1</sup>	Environmental Benefit
Location	Site structure above mean high water	Allows intertidal zone to remain Allows shoreline vegetation to remain Does not interfere with littoral drift
	Avoid wetland sites, spawning beds, shore-bird and turtle nesting beaches	Resource conservation
	Avoid nearby coral reef and seagrass beds	Resource conservation
	Avoid archaeological sites	Preserve historical information
Construction Material	Rubble or riprap	Most desirable, natural and durable
	Treated wood and smooth concrete	Intermediate desirability Less surface area
	Steel sheet pile	Least desirable, least colonizable
	Use largest cost-effective armor stone	More stable physical habitat More size diversity of openings
Design Features	Use riprap or stair-step revetments on a slope of 1 to 1 or flatter when structures are partially submerged	Dissipates more energy More habitat for fish and reef fish
	Use toe protection on structures below mean low water	More diverse habitat Reef-like properties Dissipates wave energy on the bottom
	Use sloping structures and avoid vertical structures, especially when a structure is partially submerged	Wave energy not reflected
	Use floating or pile-supported structures for access to vessels	Avoids problems of vertical walls
	Use natural shoreline contours and avoid sharp angles	Aesthetically pleasing

<sup>1</sup> Where applicable and possible.



**EM 1110-2-1614**  
**30 Jun 95**

with the expected conditions resulting from each alternative. Environmental features should be integral parts of the project, not additions made late in design or afterward.

## Appendix A References

### EM 1110-2-1601

Hydraulic Design of Flood Control Channels

### EM 1110-2-1612

Ice Engineering

### EM 1110-2-1901

Seepage Analysis and Control for Dams

### EM 1110-2-2000

Standard Practice for Concrete for Civil Works Structures

### EM 1110-2-2300

Earth and Rock-fill Dams General Design and Construction Considerations

### EM 1110-2-2906

Design of Pile Foundations

### EM 1110-2-3300

Beach Erosion Control and Shore Protection Studies

### CW 02215

Geotextiles Used as Filters

Shore Protection Manual (SPM), 4th ed., Vols I and II, U.S. Army Engineer Waterways Experiment Station, Coastal Engineering Research Center. Available from Superintendent of Documents, U.S. Government Printing Office, Washington, DC 20402.

Automated Coastal Engineering System (ACES), vers. 1.06, 1990, U.S. Army Engineer Waterways Experiment Station, Coastal Engineering Research Center. Available from Superintendent of Documents, U.S. Government Printing Office, Washington, DC 20402.

Low-Cost Shore Protection: Final Report on the Shoreline Erosion Control Demonstration Program (Section 54). 1981. Available from Department of the Army, Office of the Chief of Engineers, Pulaski Building, Washington, DC 20314-1000.

### Ahrens 1975

Ahrens, J. P. 1975 (May). "Large wave tank tests of riprap stability," CERC Technical Memorandum 51, U.S. Army Engineer Waterways Experiment Station, Vicksburg, MS.

### Ahrens 1981a

Ahrens, J. P. 1981 (Dec). "Design of riprap revetments for protection against wave attack," CERC Technical Paper 81-5, U.S. Army Engineer Waterways Experiment Station, Vicksburg, MS.

### Ahrens 1981b

Ahrens, J. P. 1981 (Dec). "Irregular wave runup on smooth slopes," CERC Coastal Engineering Technical Aid 81-17, U.S. Army Engineer Waterways Experiment Station, Vicksburg, MS.

### Ahrens 1987

Ahrens, J. P. 1987 (Dec). "Characteristics of reef breakwaters," CERC Technical Report 87-17, U.S. Army Engineer Waterways Experiment Station, Vicksburg, MS.

### Ahrens and Heimbaugh 1988

Ahrens, J. P. and Heimbaugh, M. S. 1988 (May). "Approximate upper limit of irregular wave runup on riprap," Technical Report CERC-88-5, U.S. Army Engineer Waterways Experiment Station, Vicksburg, MS.

### Asphalt Institute 1965

The Asphalt Institute. 1965 (Mar). "Asphalt in hydraulic structures," Manual Series No. 12, College Park, MD.

### Barnard 1978

Barnard, W. D. 1978 (Aug). "Prediction and control of dredged material dispersion around dredging and open-water pipeline disposal operations," Technical Report DS-78-13, U.S. Army Engineer Waterways Experiment Station, Vicksburg, MS.

### Birkemeier 1980

Birkemeier, W. 1980. "The effect of structures and lake level on bluff and shore erosion in Berrien County, Michigan, 1970-74," CERC Miscellaneous Paper 80-2, U.S. Army Engineer Waterways Experiment Station, Vicksburg, MS.

### Brater et al. 1974

Brater, E. F., et al. 1974 (Nov). "Michigan's demonstration erosion control program," Evaluation Report, Michigan Department of Natural Resources, Lansing, MI.

### Brebner and Donnelly 1962

Brebner, A., and Donnelly, P. 1962. "Laboratory study of rubble foundations for vertical breakwaters," Engineer Report No. 23, Queen's University at Kingston, Ontario.

**Broderick 1983**

Broderick, L. 1983 (Mar). "Riprap stability, a progress report." *Proceedings Coastal Structures '83*, Arlington, VA.

**Camfield 1991**

Camfield, F. E. 1991 (Jan/Feb). "Wave forces on wall," *Journal of Waterway, Port, Coastal, and Ocean Engineering Division, American Society of Civil Engineers* 117 (1), 76-9.

**Carstea et al. 1975a**

Carstea, D., et al. 1975. "Guidelines for the analysis of the cumulative environmental effects of small projects in navigable waters," Mitre Technical Report MTR 6939, U.S. Army Corps of Engineers, Washington, DC.

**Carstea et al. 1975b**

Carstea, D., et al. 1975. "Guidelines for the environmental impact assessment of small structures and related activities in coastal bodies of water," Technical Report MTR-6916, The Mitre Corp., McLean, VA.

**Chen et al. 1981**

Chen, Y. H., et al. 1981 (Sep). "Hydraulic testing of plastic filter fabrics," *Journal, Irrigation and Drainage Division, American Society of Civil Engineers* 107 (IR3), 307-24.

**Corson et al. 1981**

Corson, W. D., et al. 1981 (Jan). "Atlantic Coast hind-cast, deepwater significant wave information," Wave Information Study Report 2, U.S. Army Engineer Waterways Experiment Station, Vicksburg, MS.

**d'Angremond et al. 1970**

d'Angremond, K., et al. 1970. "Use of asphalt in break-water construction." *Twelfth International Conference on Coastal Engineering*, 1601-27.

**Dunham and Barrett 1974**

Dunham, J. W., and Barrett, R. J. 1974 (Feb). "Woven plastic cloth filters for stone seawalls," *Journal, Waterways, Harbors, and Coastal Engineering Division, American Society of Civil Engineers* 100, (WW1), 13-22.

**Ebersole 1982**

Ebersole, B. A. 1982 (Apr). "Atlantic Coast water-level climate," WIS Report 7, U.S. Army Engineer Waterways Experiment Station, Vicksburg, MS.

**Eckert 1983**

Eckert, J. W. 1983. "Design of toe protection for coastal structures," *Coastal Structures '83 ASCE Specialty Conference*, 331-41.

**Escoffier and Dolive 1954**

Escoffier, F. F., and Dolive, W. L. 1954 (July). "Shore protection in Harrison County, Mississippi," *Bulletin of the Beach Erosion Board*, 8 (3).

**Everts et al. 1980**

Everts, C., et al. 1980. "Beach and inlet changes at Ludlam Beach, New Jersey," CERC Miscellaneous Report 80-3, U.S. Army Engineer Waterways Experiment Station, Vicksburg, MS.

**Ford et al. 1983**

Ford, J. C., et al. 1983. "An annotated bibliography on the biological effects of construction channels, jetties, and other coastal structures," CERC Miscellaneous Paper 83-2, U.S. Army Engineer Waterways Experiment Station, Vicksburg, MS.

**Giles 1978**

Giles, M. L. 1978. "Evaluation of a concrete building block revetment," *Coastal Sediments '77 ASCE Specialty Conference*, 686-95.

**Goda 1975**

Goda, Y. 1975. "Irregular wave deformation in the surf zone," *Coastal Engineering in Japan*, Vol. 18.

**Goda 1985**

Goda, Y. 1985. *Random seas and design of maritime structures*. University of Tokyo Press.

**Goda 1987**

Goda, Y. 1987. "Statistical variability of sea state parameters as a function of wave spectrum," AIRH Seminar.

**Hall and Jachowski 1964**

Hall, J. V., Jr., and Jachowski, R. A. 1964 (Jan). "Concrete block revetment near Benedict, Maryland," CERC Miscellaneous Paper 1-64, U.S. Army Engineer Waterways Experiment Station, Vicksburg, MS.

**Hall 1967**

Hall, J. V., Jr. 1967. "Wave tests of revetment using machine-produced interlocking blocks." *Tenth International Conference on Coastal Engineering*, 1025-35.

**Harris 1981**

Harris, D. L. 1981 (Feb). "Tides and tidal datums in the united states," CERC Special Report No. 7, U.S. Army Engineer Waterways Experiment Station, Vicksburg, MS.

**Hudson 1961**

Hudson, R. Y. 1961. "Wave forces on rubble-mound breakwaters and jetties," Miscellaneous Paper 2-453, U.S. Army Engineer Waterways Experiment Station, Vicksburg, MS.

**Hudson 1974**

Hudson, R. Y. 1974 (Jan). "Concrete armor units for protection against wave attack," Miscellaneous Paper H-74-2, U.S. Army Engineer Waterways Experiment Station, Vicksburg, MS.

**Hudson et al. 1979**

Hudson, R. Y., et al. 1979. "Coastal hydraulic models," CERC Special Report 5, U.S. Army Engineer Waterways Experiment Station, Vicksburg, MS.

**Hughes and Borgman 1987**

Hughes, S. A., and Borgman, L. E. 1987 (Jun). "Beta-rayleigh distribution for shallow water wave heights," *Proceedings of Conference Sponsored by WW Div./ASCE*, Newark, DE.

**Hurme 1979**

Hurme, A. E. 1979. "Rubble-mound structures as artificial reefs." *Coastal Structures '79 ASCE Specialty Conference*, Vol 2, 1042-51.

**Johnson and DeWitt 1978**

Johnson, G. F., and DeWitt, L. A. 1978. "Ecological effects of an artificial island, Rincon Island, Punta Gorda, California," CERC Miscellaneous Report 78-3, U.S. Army Engineer Waterways Experiment Station, Vicksburg, MS.

**Kaiser Aluminum and Chemical Sales 1979**

Kaiser Aluminum and Chemical Sales. 1979. "A practical design method for flexible marine retaining walls." Oakland, CA.

**Leenknecht et al. 1989**

Leenknecht, D. A., Szuwalski, A., Sherlock, A. R., and George, M. 1989 (Aug). "Automated coastal engineering

system, user guide," U.S. Army Engineer Waterways Experiment Station, Vicksburg, MS.

**Markle 1981**

Markle, D. G. 1981 (Sep). "Breakwater and revetment stability study, San Juan National Historic Site, San Juan, Puerto Rico," Technical Report HL-81-11, U.S. Army Engineer Waterways Experiment Station, Vicksburg, MS.

**Markle 1982**

Markle, D. G. 1982 (Nov). "Revetment stability study of Fort Fisher Historic Site, North Carolina," Technical Report HL-82-26, U.S. Army Engineer Waterways Experiment Station, Vicksburg, MS.

**Markle and Davidson 1979**

Markle, D. G., and Davidson, D. D. 1979. "Placed-stone stability tests, Tilamook, Oregon," Technical Report HL-79-16, U.S. Army Engineer Waterways Experiment Station, Vicksburg, MS.

**Mather 1957**

Mather, B. 1957 (Jun). "Factors affecting the durability of concrete in coastal structures," CERC Technical Memorandum 96, U.S. Army Engineer Waterways Experiment Station, Vicksburg, MS.

**McCartney 1976**

McCartney, B. L. 1976 (May). "Survey of coastal revetment types," CERC Miscellaneous Report 76-7, U.S. Army Engineer Waterways Experiment Station, Vicksburg, MS.

**McCartney and Ahrens 1975**

McCartney, B. L., and Ahrens, J. P. 1975 (Oct). "Stability of gobi block revetment to wave attack," CERC Technical Memorandum 55, U. S. Army Engineer Waterways Experiment Station, Vicksburg, MS.

**McCartney and Ahrens 1976**

McCartney, B. L., and Ahrens, J. P. 1976 (Dec). "Overlay of large placed quarystone and boulders to increase riprap stability," CERC Technical Paper 76-19, U.S. Army Engineer Waterways Experiment Station, Vicksburg, MS.

**Mohl and Brown 1967**

Mohl, E. V., and Brown, J. D. 1967 (Oct). "Flexible revetment using interlocking concrete blocks, Tilghman Island, Maryland," *Shore and Beach*, 28-30.

**Mulvihill et al. 1980**

Mulvihill, E. L., et al. 1980. *Biological impacts of minor shoreline structures on the coastal environment: State of the art review*. FWS/OBS77/51, 2 vols, U.S. Fish and Wildlife Service, Biological Services Program, Washington, DC

**Ravens Metal Products 1981**

Ravens Metal Products. 1981. *Ravens retaining walls technical manual*. Parkersburg, WV.

**Resio and Vincent 1976-1978**

Resio, D. T., and Vincent, C. L. 1976-1978. "Design wave information for the Great Lakes; Report 1 - Lake Erie; Report 2 - Lake Ontario; Report 3 - Lake Michigan; Report 4 - Lake Huron; Report 5 - Lake Superior," Technical Report H-76-1, U.S. Army Engineer Waterways Experiment Station, Vicksburg, MS.

**Richart and Schmertmann 1958**

Richart, F. E., Jr., and Schmertmann, J. H. 1958. "The effect of seepage on the stability of sea walls." *Sixth International Conference on Coastal Engineering*, 105-28.

**Schneider 1981**

Schneider, C. 1981 (Mar). "The littoral environment observation (LEO) data collection program," CERC Coastal Engineering Technical Aid 81-5, U.S. Army Engineer Waterways Experiment Station, Vicksburg, MS.

**Stoa, P. N. 1979**

Stoa, P. N. 1979 (Jul). "Wave runup on rough slopes," CERC Coastal Engineering Technical Aid 79-1, U.S. Army Engineer Waterways Experiment Station, Vicksburg, MS.

**Seelig 1971**

Seelig, H. H. 1971. *Corrosion and corrosion control*. 2d ed., Wiley and Sons, New York.

**Technical Standards for Port and Harbour Facilities in Japan 1980**

*Technical standards for port and harbor facilities in Japan*. 1980. Overseas Coastal Development Institute of Japan, Tokyo, Japan.

**Thompson and Vincent 1985**

Thompson, E. F., and Vincent, C. L. 1985 (Sep). "Significant wave height for shallow water design," *ASCE Journal of Waterways, Port, Coastal and Ocean Engineering* 111 (5).

*Journal of Waterways, Port, Coastal and Ocean Engineering* 111 (5).

**Uhlig 1971**

Uhlig, H. H. 1971. *Corrosion and corrosion control*. 2nd ed., Wiley and Sons, New York.

**U.S. Army Engineer Waterways Experiment Station 1957**

U.S. Army Engineer Waterways Experiment Station. 1957. "Wave runup and overtopping, levee sections, Lake Okeechobee, Florida," Report No. 2-449, Vicksburg, MS.

**U.S. Army Engineer Waterways Experiment Station 1962**

U.S. Army Engineer Waterways Experiment Station. 1962. "Design of riprap cover layers for railroad relocation fills, Ice Harbor, and John Day Lock and Dam Projects," Miscellaneous Paper 2-465, Vicksburg, MS.

**U.S. Army Engineer Waterways Experiment Station 1966**

U.S. Army Engineer Waterways Experiment Station. 1966. "Investigation of in-shore harbor, Site X, Report 2, design of riprap cover layers," Technical Report 2-740, Vicksburg, MS.

**United States Steel Corporation 1975**

United States Steel Corporation. 1975. *Steel Sheetpiling Design Manual*. Pittsburgh, PA.

**van der Meer 1988a**

van der Meer, J. W. 1988 (Jan). "Deterministic and probabilistic design of breakwater armour layers," *ASCE Journal of Waterways, Port, Coastal, and Ocean Engineering* 114 (1), 66-80.

**van der Meer 1988b**

van der Meer, J. W. 1988 (Jan). "Rock slopes and gravel beaches under wave attack," Ph.D. Thesis Dept. of Civil Engineering, Delft Technical University. Also, Delft Hydraulics Communication No. 396, Delft, The Netherlands, Apr. 1988.

**van der Meer and Pilarczyk 1987**

van der Meer, J. W., and Pilarczyk, K. W. 1987 (Feb). "Stability of breakwater armour layers deterministic and probabilistic design," Delft Hydraulics Communication No. 378, Delft, The Netherlands.

**Ward 1992**

Ward, D. L. 1992 (Apr). "Prediction of overtopping rates for irregular waves on riprap revetments," CERC Miscellaneous Paper 92-4, U.S. Army Engineer Waterways Experiment Station, Vicksburg, MS.

**Ward and Ahrens 1992**

Ward, D. L., and Ahrens, J. P. 1992 (Apr). "Overtopping rates for seawalls," CERC Miscellaneous Paper 92-3, U.S. Army Engineer Waterways Experiment Station, Vicksburg, MS.

**Weggel 1972**

Weggel, J. R. 1972. "Maximum breaker height for design," *Journal, Waterways, Harbors and Coastal*

*Engineering Division*, American Society of Civil Engineers 98 (WW4), Paper 9384.

**Wilder and Dinchak 1979**

Wilder, C. R., and Dinchak, W. G. 1979. "Soil-cement for shore protection." *Coastal Structures '79 ASCE Specialty Conference*, 301-13.

**Wilder and Koller 1971**

Wilder, C. R., and Koller, E. R. 1971 (Oct). "Modular systems for shore protection," *Civil Engineering* 41 (10), 60-63.

## Appendix B Revetments

### B-1. Quarystone and Graded Riprap

a. *General.* Stone revetments are constructed either of nearly uniform size pieces (quarystone) or of a gradation of sizes between upper or lower limits (riprap). Riprap revetments are somewhat more difficult to design and inspect because of the required close control of allowable gradations (pockets of small material must be excluded) and their tendency to be less stable under large waves. Economy can usually be obtained by matching the riprap design gradation limits to the local quarry-yield gradation, provided the disparity is not too great. Graded riprap revetments should be used with caution, but they are acceptable for low energy shore protection applications. Uniform quarystone structures, being more stable, are recommended for high energy waves.

b. *Advantages and disadvantages.* The primary advantage of rubble revetments is their flexibility, which allows them to settle into the underlying soil or experience minor damage yet still function. Because of their rough surface, they also experience less wave runup and overtopping than smooth-faced structures. A primary disadvantage is that stone placement generally requires heavy equipment.

c. *Design considerations.* In most cases, the steepest recommended slope is 1 on 2. Fill material should be added where needed to achieve a uniform slope, but it should be free of large stones and debris and should be firmly compacted before revetment construction proceeds. Allowance should be made for conditions other than waves such as floating ice, logs, and other debris. Current velocities may also be important in some areas such as within tidal inlets where wave heights are low. Properly sized filter layers should be provided to prevent the loss of slope material through voids in the revetment stone. If using filter cloth, an intermediate layer of smaller stone below the armor layer may be needed to distribute the load and prevent rupture of the cloth. Economic evaluation of rock revetments should include consideration of trade-offs that result between flatter slopes and smaller stone weights and the increased costs for excavation that usually result for flatter slopes.

d. *Design factors.*

(1) Zero-damage wave height is a function of stone weight.

(2) Wave runup potential is estimated to be as low as 50 percent of smooth slope runup.

(3) Wave reflection potential is estimated to be low.

e. *Prototype installations (Figures B-1 and B-2).* Rock revetments are commonly found throughout the United States with good examples existing in almost all coastal locations.

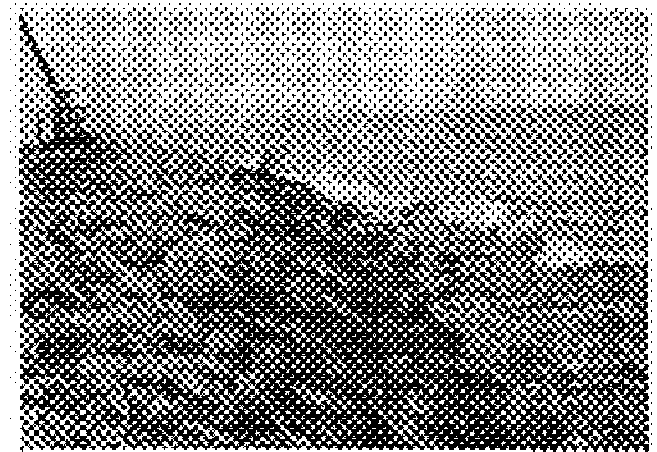

Figure B-1. Quarystone revetment at Tawas Point, MI

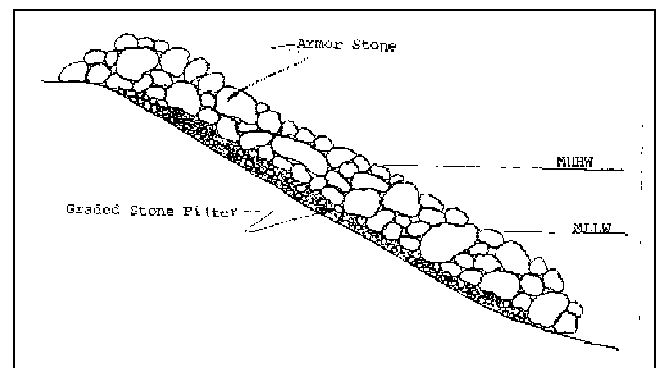

Figure B-2. Quarystone revetment cross section

### B-2. Rock Overlay

a. *General.* A rock overlay consists of a layer of large quarystone used either to upgrade a damaged or undersized stone revetment or to provide economical initial design. Large-scale model tests (McCartney and Ahrens 1976) suggest that stability of such overlays is about equal to a standard design but with only about one-half the reserve strength.

*b. Design factors.*

(1) Zero-damage wave height is a function of stone weight.

(2) Wave runup potential is estimated to be as low as 50 percent of smooth slope runup.

(3) Wave reflection is expected to be low.

*c. Prototype installations (Figures B-3 and B-4).* A rock overlay was used to rehabilitate a damaged riprap revetment along a railroad embankment on Lake Oahe, near Mobridge, SD. The existing riprap revetment had been damaged by 5-ft waves along 2,700 ft of the 4,500-ft-long embankment. A zero-damage wave height of 5 ft was adopted for design. The rock overlay was sized so that  $W_{50}$  was 300 lb (16 in.), and the gradation limits were 150 to 600 lb (13 to 20 in.). A layer thickness of 16 to 18 in. was selected for above-water placement. This was increased to 30 in. for underwater portions of the section. The overlay covered the entire 4,500 ft of existing revetment. Overlay construction was completed in 1971 and was reported to be stable through 1976.

### B-3. Field Stone

*a. General.* A field stone revetment can be constructed using a single layer of heavy subrounded to rounded boulders as the armor layer. Special placement is needed to obtain a close-fitting section. The rounded shapes would normally be considered inadequate for multilayered structures, but satisfactory performance is possible when care is used in placement.

*b. Design factors.*

(1) Zero-damage wave height is a function of stone weight.

(2) Wave runup potential is estimated to be as low as 50 percent of smooth slope runup.

(3) Wave reflection is expected to be low.

*c. Prototype installation (Figures B-5 and B-6).* A 5,900-ft-long revetment was built in May 1980 at Kekaha, Kauai, HI, with a southern exposure on the open Pacific coast. The crest elevation is +12 ft MLLW, and the slope is 1 on 1.5. Armor stone weights range from 1.5 to

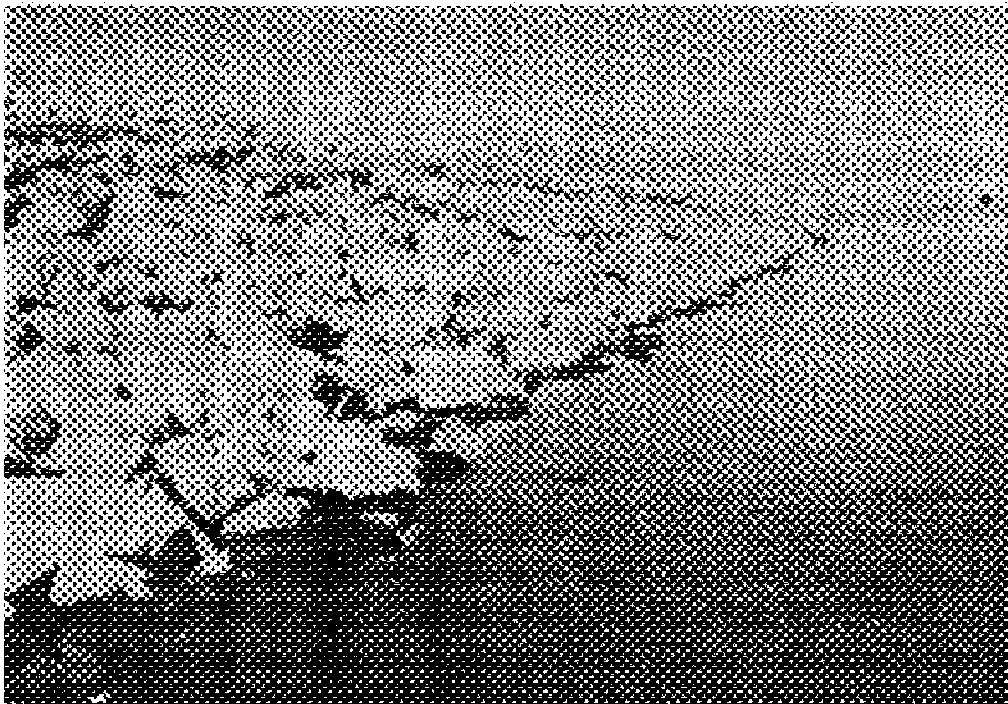

Figure B-3. Large stone overlay revetment at Oahe Reservoir, SD



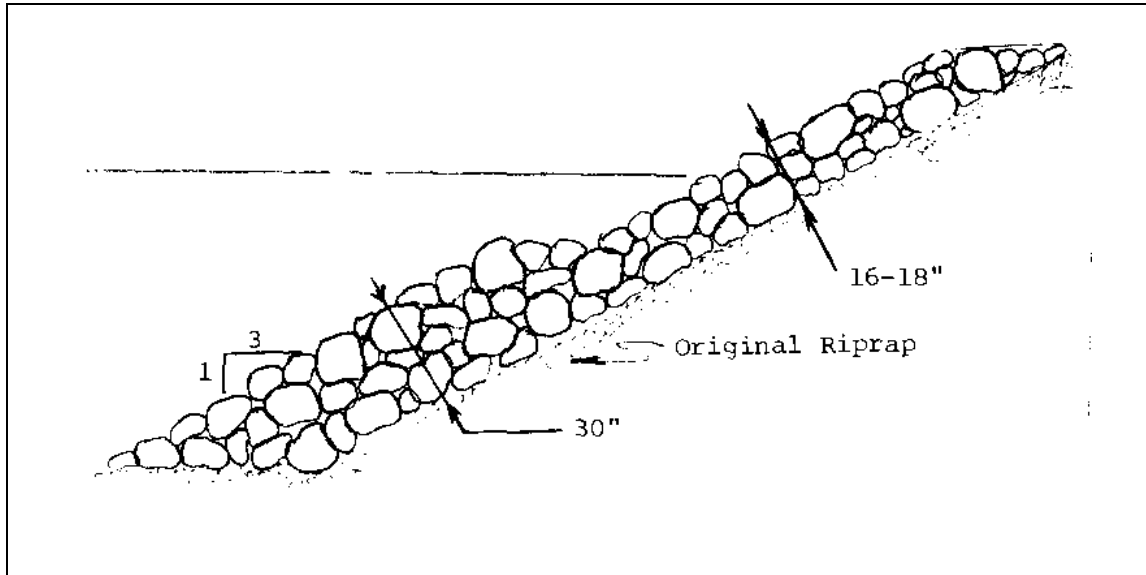

Figure B-4. Large stone overlay revetment cross section

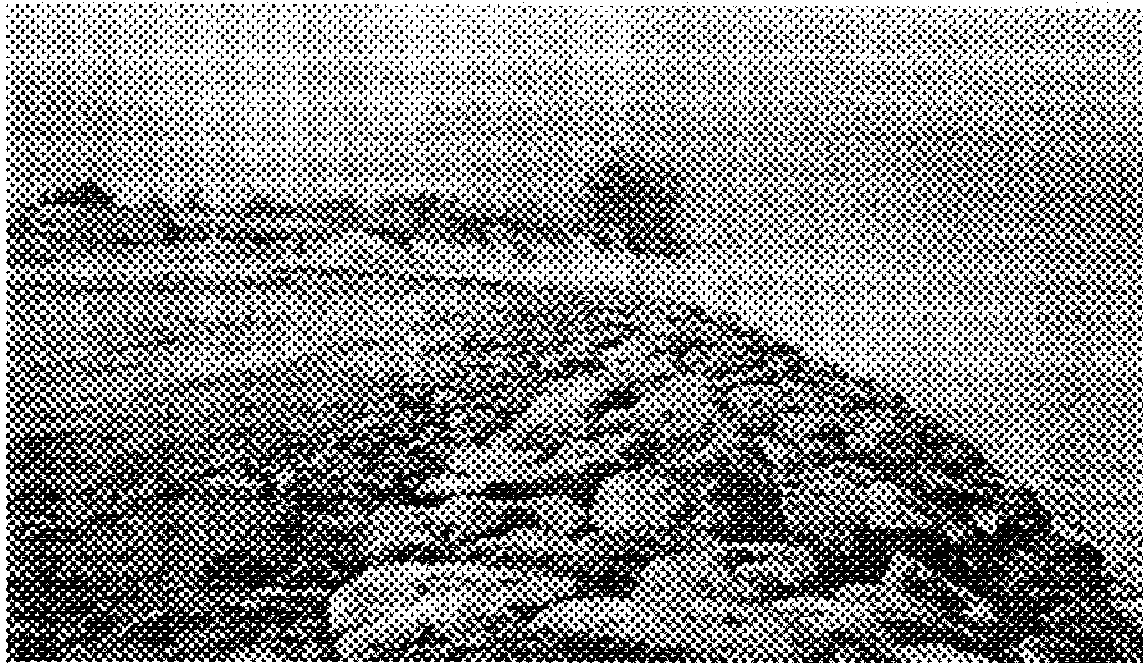

Figure B-5. Field stone revetment at Kekaha Beach, Kauai, HI

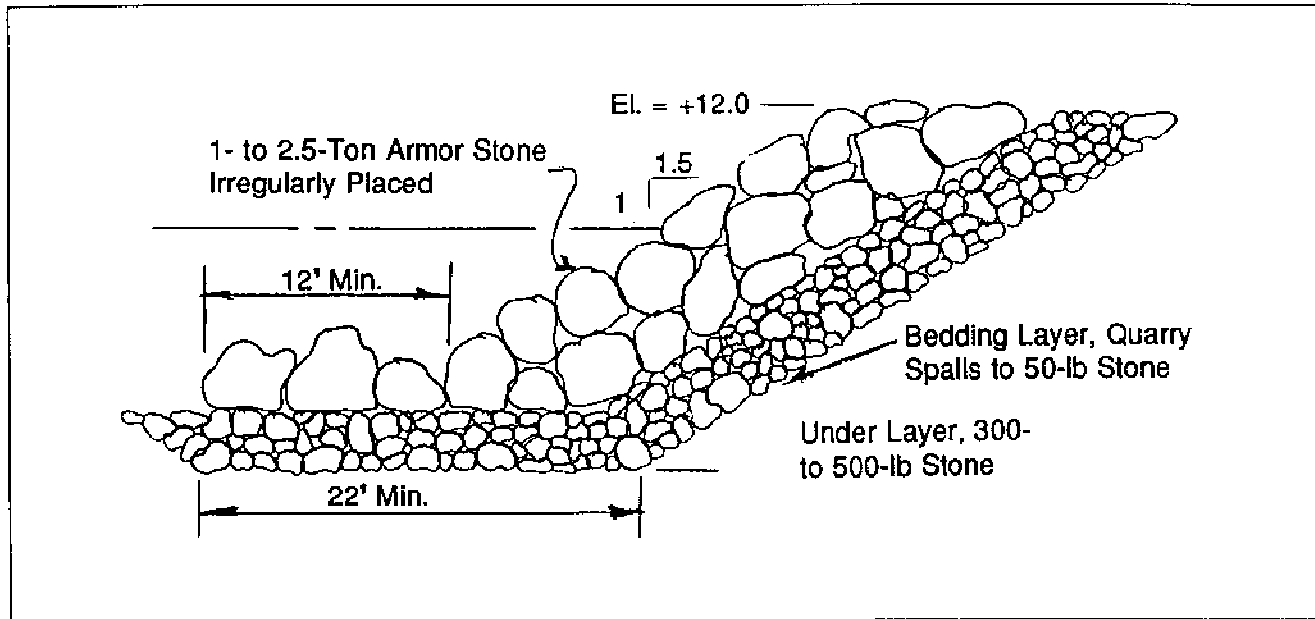

Figure B-6. Field stone revetment cross section

2.5 tons, with underlayer stone from 300 to 500 lb, and a bedding layer that ranges from quarry spalls to 50-lb stone. Mean tide range at the site is 1.6 ft.

#### B-4. Broken Concrete Rubble

*a. General.* A concrete rubble revetment utilizes a waste product that otherwise is usually a nuisance. The concrete used in such structures should have the durability to resist abrasion by waterborne debris and attack by salt water and freeze-thaw cycles. In addition, all protruding reinforcing bars should be burned off prior to placement. Failures of concrete revetments have frequently occurred in the past, mostly because of neglect of drainage and filtering requirements. Revetments that have failed at many locations have often consisted of a single layer of rubble dumped on a slope. An improved procedure would be a thicker layer of rubble, with each piece shaped so that the longest dimension is no greater than three times the shortest, thus increasing the revetment stability and minimizing uplift from wave forces. The rubble would be laid directly on the filter layer. An alternative method would utilize shaped-rubble, stacked on a slope, to create a stepped face.

*b. Design factors (estimated).*

- (1) Zero-damage wave height is less than 3 ft.

- (2) Wave runup potential for random placement is to be as low as 50 percent of smooth slope runup.

- (3) Wave reflection potential for random placement is estimated to be as low as 50 percent.

*c. Prototype installations (Figures B-7 and B-8).* The final report on the Shore Erosion Control Demonstration Program (Section 54) contains an example of a concrete rubble revetment at Shoreacres, TX, on the northwest shore of upper Galveston Bay, about 15 miles southeast of Houston. The fetch length at the site is about 3 miles, and waves are seldom greater than 3 ft high. Constructed in 1976, it weathered several major storms without significant damage through the end of 1980. No filter material was used, but the rubble was broken into a wide gradation. The structure thickness permitted the natural formation of a filter through sorting processes. This would be expected to occur only for thick revetments containing well-graded rubble. For poorly graded, thinner structures, a properly designed filter layer must be provided. Other examples of concrete rubble revetments occur throughout the United States.

#### B-5. Asphalt

*a. General.* Asphalt has been used for revetment construction in a number of ways: as standard asphaltic

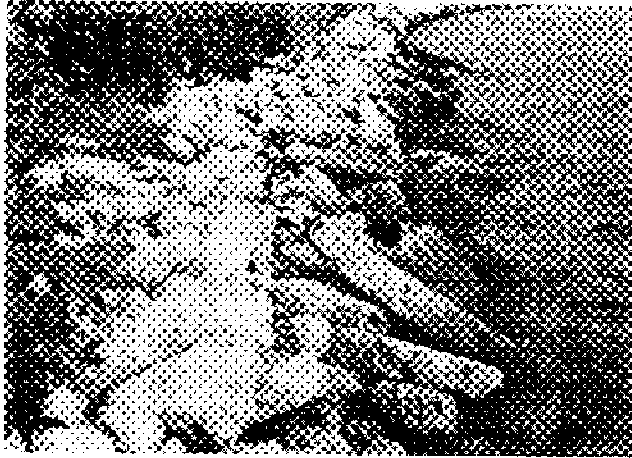

Figure B-7. Broken concrete revetment at Shore Acres, TX

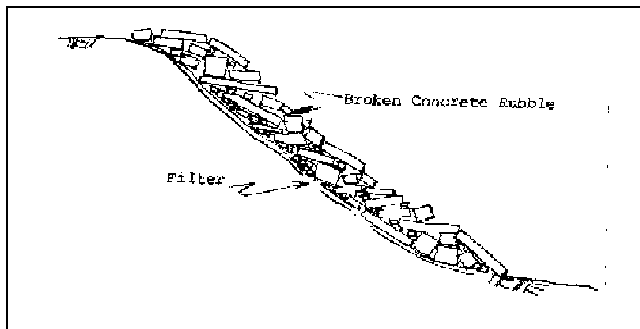

Figure B-8. Broken concrete revetment cross section

concrete paving, as asphalt mastic to bind large stones, and as patch asphalt to join small groups of stone (5 to 10) when it is poured on a slope.

*b. Asphaltic concrete paving.* Asphaltic concrete paving consists of a standard paving that is placed on a slope as armoring. Stability is an unknown function of the layer thickness. The paving is somewhat flexible which does enhance its stability, but proper filtering and hydrostatic pressure relief are essential due to the impermeable nature of asphalt paving. In addition, asphalt placement underwater is difficult and expensive, and quality control is difficult.

*c. Asphalt mastic.* In an asphalt mastic revetment, a layer of riprap or quarystone is bound by pouring hot asphalt over it. This results in a rock-asphalt matrix with superior stability compared to plain rock used alone. Underwater construction is a problem since the mastic cools too quickly to effectively penetrate and bind the

rocks together. The extent of this problem is a function of the water depth.

*d. Patch asphalt.* Patches of asphalt can be poured on a rock slope to bind 5 to 10 rocks together. Model tests revealed an increase in the stability coefficient of two or three times over a nonpatch asphalt slope (McCartney and Ahrens 1976). This procedure has potential either for repairing damaged revetment sections or for original construction. A layer thickness equal to three nominal stone diameters is recommended with the patch generally penetrating only the top two-thirds. The bottom one-third then serves as a reserve should the patch be washed out (d'Angremond et al. 1970).

*e. Design factors.*

(1) Zero-damage wave height is estimated to be for:

Paving: Function of layer thickness

Mastic: 2 to 4 ft

Patch: Function of rock size

(2) Wave runup potential is estimated to be for:

Paving: 100 percent of smooth slope runup

Mastic: 80-100 percent of smooth slope runup as function of the thickness of mastic

Patch: 60-70 percent of smooth slope runup

(3) Wave reflection potential is estimated for:

Paving and Mastic: High

Patch: Medium

*f. Prototype installations.* Asphalt paving was used at the Glen Anne Dam in California. This consisted of a 1-ft-thick layer of slope protection on the 1 on 4 upstream dam face. A similar treatment was tested at Bonny Dam in Colorado (Figure B-9) (McCartney 1976). At another site at Point Lookout, MD, an asphalt concrete revetment protects both sides of a 2,200-ft-long causeway that extends into Chesapeake Bay. The revetment, placed on a 1 on 4 slope, is 4 in. thick. It was placed in two lifts with welded wire fabric placed between the lifts (Asphalt Institute 1965). Long-term performance data are not available. A rock-asphalt mastic revetment was

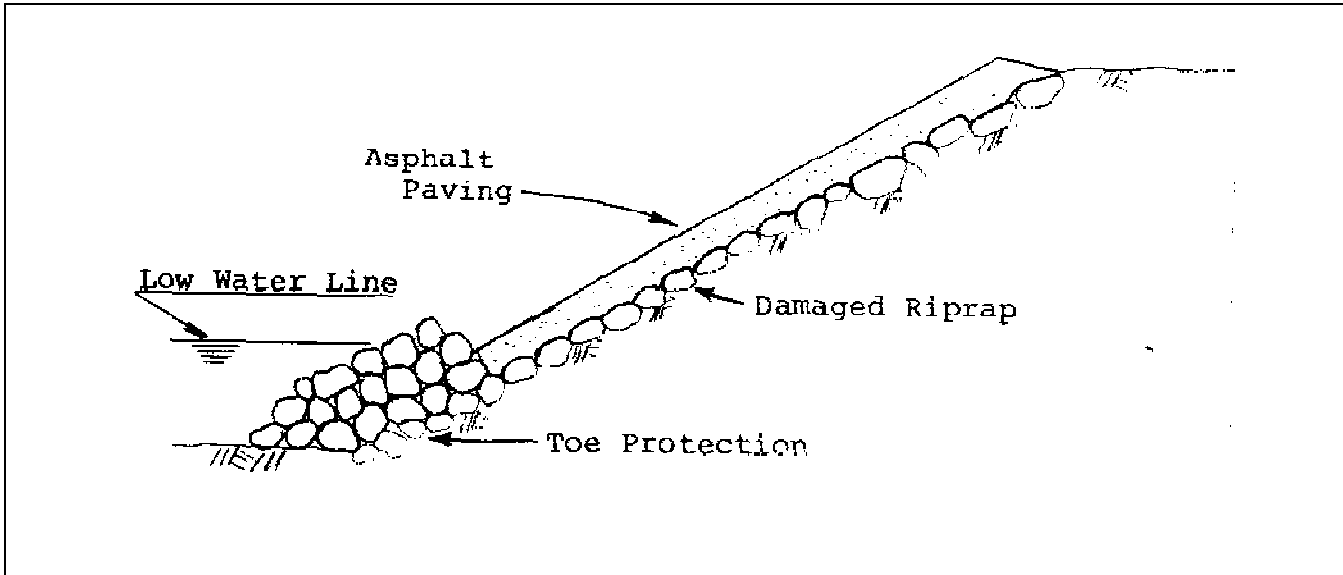

Figure B-9. Asphaltic concrete revetment cross section

installed at Michiana, MI, on Lake Michigan. It consisted of a thin layer of small rock (less than 12 in.) covered with asphalt to form a mat. This revetment performed well for a short time then deteriorated (Brater et al. 1974). No prototype installations of patch asphalt revetments have been reported.

### B-6. Concrete Armor Units

*a. General.* Concrete armor units such as tribars, tetrapods, and dolosse can be used in place of stone for rubble structures, including revetments. Size selection is in accordance with the methods outlined in paragraphs 2-15 to 2-18. As described in those paragraphs, some kinds of armor units exhibit stability against wave attack equaling two to six times that of equal weight armor stones. Concrete units, however, are usually not economical where there is a local source of suitable rock.

*b. Design factors.*

- (1) Zero-damage wave height is a function of armor unit size.
- (2) Wave runup potential is estimated to be 50 to 80 percent of smooth slope runup.
- (3) Wave reflection potential is estimated to be low to medium.

*c. Prototype installations.* Hudson (1974) contains examples of coastal structures utilizing concrete armor units. In addition, model tests of various armor unit shapes have been made by CERC (McCartney 1976) at WES (Figures B-10 and B-11) and other laboratories.

### B-7. Formed Concrete

*a. General.* Revetments of this kind consist of a slab-on-grade cast in place at the site. The face can be smooth or stepped, and the structure may be capped with a curved lip to limit overtopping from wave runup. Toe protection may be either dumped rock or a sheet pile cut-off wall, and provision must be made for relief of hydrostatic pressures behind the wall and for proper filtering. Construction of this kind is usually more expensive than riprap or quarrystone.

*b. Design factors.*

- (1) Zero-damage wave height is a function of concrete thickness.
- (2) Wave runup potential is estimated to be 100 percent of smooth slope runup.
- (3) Wave reflection potential is estimated to be high.

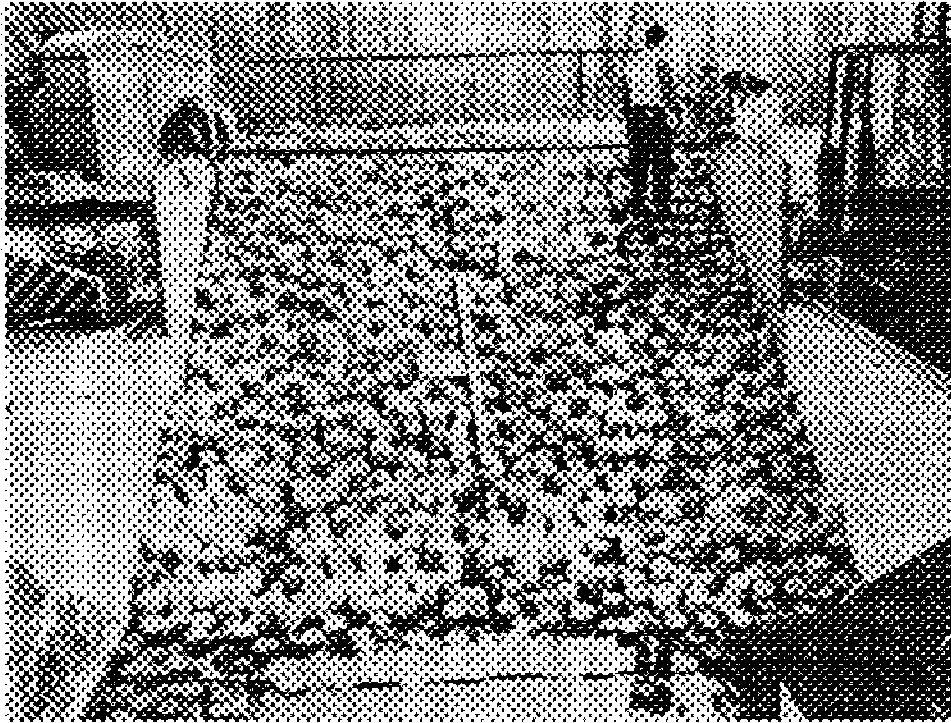

Figure B-10. Concrete tribars (armor unit) test section at CERC, Fort Belvoir, VA

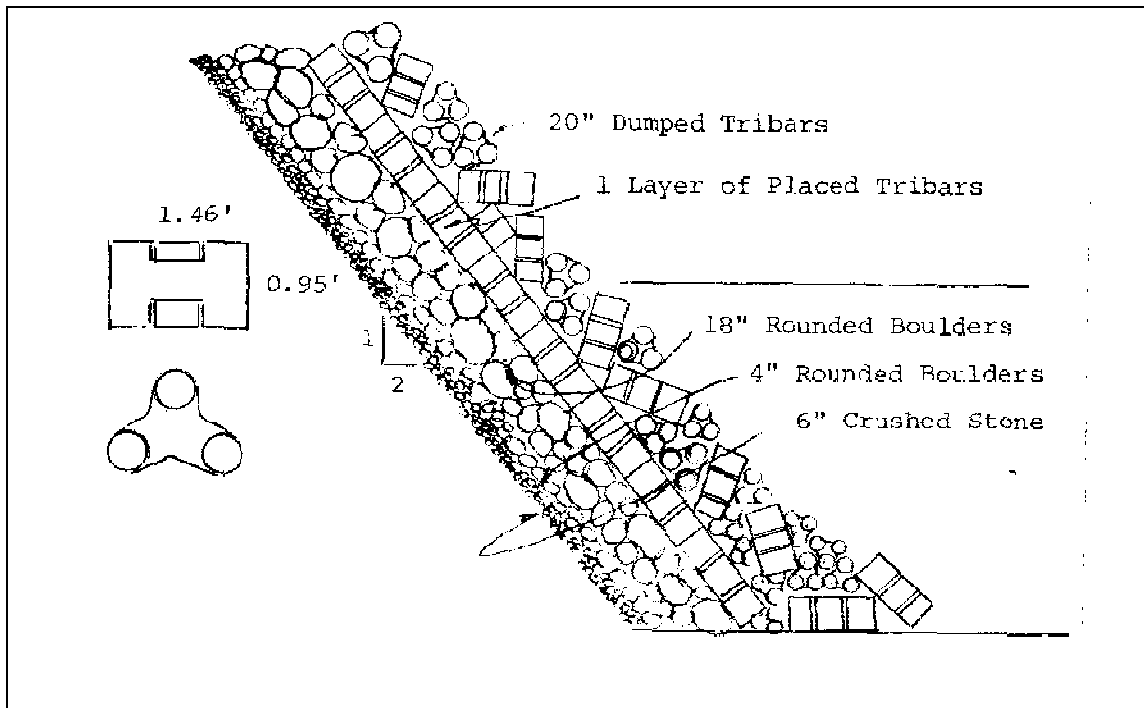

Figure B-11. Concrete tribar revetment cross section

c. *Prototype installations.* A revetment of formed concrete was built before 1966 at Cambridge, MD (Figures B-12 and B-13). Subsequent performance data are unavailable, but such revetments should be relatively maintenance-free for many years provided there is control over toe scour and flanking. Revetments similar to the one shown have been built throughout the United States.

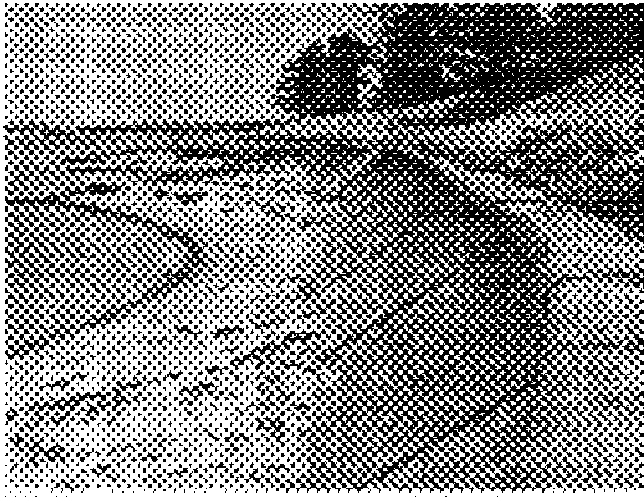

Figure B-12. Formed concrete revetment, Pioneer Point, MD

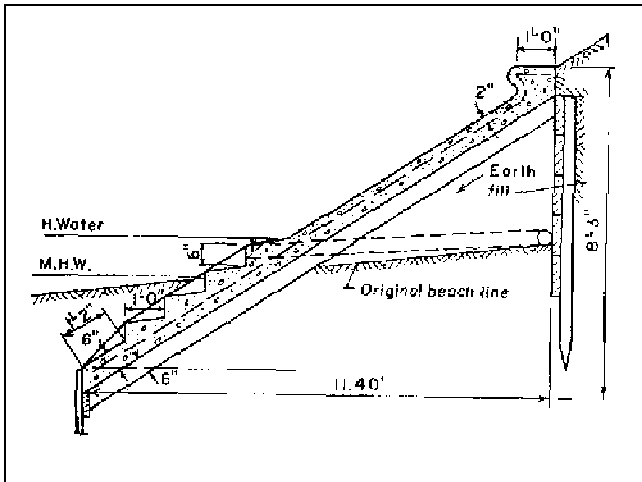

Figure B-13. Formed concrete revetment cross section

### B-8. Concrete Blocks (Figure B-14)

Prefabricated concrete blocks are commonly used as a substitute for quarystone or riprap. Many designs are available, and new shapes are being offered on a regular

basis to replace those that have not been accepted by the marketplace. Designers must be prepared to invest time to stay abreast of current developments in this field. Revetment blocks are usually designed with various intermeshing or interlocking features, and many of the units are patented. Blocks have the advantage of a neat, uniform appearance, and many units are light enough to be installed by hand once the slope has been prepared. The disadvantage of concrete blocks is that the interlocking feature between units must be maintained. Once one block is lost, other units soon dislodge and complete failure may result. A stable foundation is required since settlement of the toe or subgrade can cause displacement of the units and ultimate failure. Also, most concrete block revetments have relatively smooth faces that can lead to significantly higher wave runoff and overtopping than those with dumped rock.

### B-9. Gobi (Erco) and Jumbo Blocks and Mats

a. *General.* Gobi blocks are patented units that weigh about 13 lb each. Erco blocks are similar, but they are offered by a different licensed manufacturer. Jumbo blocks are large-sized Erco blocks that weigh about 105 lb each. The units are designed for hand placement on a filter cloth, or they are factory-glued to carrier strips of filter cloth. The latter are called Gobimats (Ercomats) or Jumbo Ercomats, depending on the size of the units. If the blocks are glued to both sides of the carrier strip, back-to-back, they are called double Gobimats (Ercomats) or double Jumbo Ercomats. The blocks used for producing mats have tapered sides to facilitate bending. Blocks designed for hand placement have vertical sides to provide the tightest possible fit. Mats are preferred at sites where vandalism or theft is possible. Both single and double mats require machine placement. Back filling of the blocks with sand or gravel increases the stability of the revetment, and any grass that grows through the block openings will further increase the strength.

b. *Design factors.*

Zero-damage wave height:

Blocks: 2 ft (McCartney 1976)  
Mats: 4 ft (estimated)

Wave runoff potential: 90 percent of smooth slope runoff (Stoa 1979)

Wave reflection potential: High (estimated)

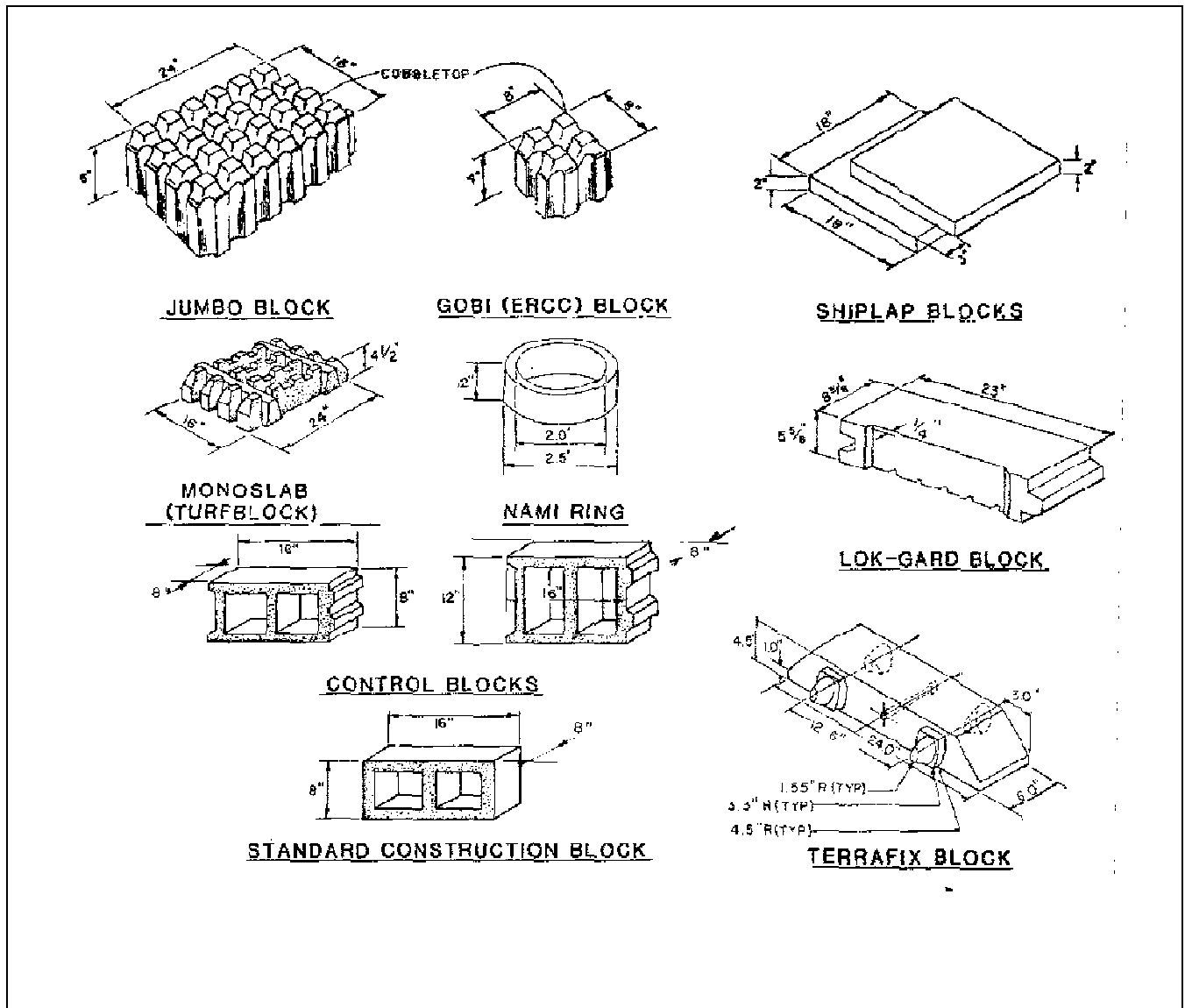

Figure B-14. Concrete revetment blocks

c. *Prototype installations (Figures B-15 and B-16).* According to the final report on the Shoreline Erosion Control Demonstration Program (Section 54) the largest Gobi block revetment in the United States is probably the one located at Holly Beach, LA, which occupies about 4 miles of shore front. Installed in 1970 and repaired and extended in 1976, the revetment suffered only relatively minor damages prior to Tropical Storm Claudette in July 1979, which displaced or otherwise damaged about one-half of the revetment. Waves during that storm probably exceeded the design condition, and the blocks, individually placed, were susceptible to unravelling after the initial blocks were lost. Use of mats with the blocks glued to

the carrier strips would be preferable for areas where waves greater than 3 ft are likely.

#### B-10. Turfblocks or Monoslabs

a. *General.* Turfblocks are patented units that are designed for hand placement on a filter with the long axes parallel to the shoreline. Each block measures 16 × 24 × 4.5 in. and weighs approximately 100 lb. Field installations have not yielded conclusive results, but their performance should be similar to that of Jumbo Erco blocks. Their thin, flat shape requires a stable foundation,

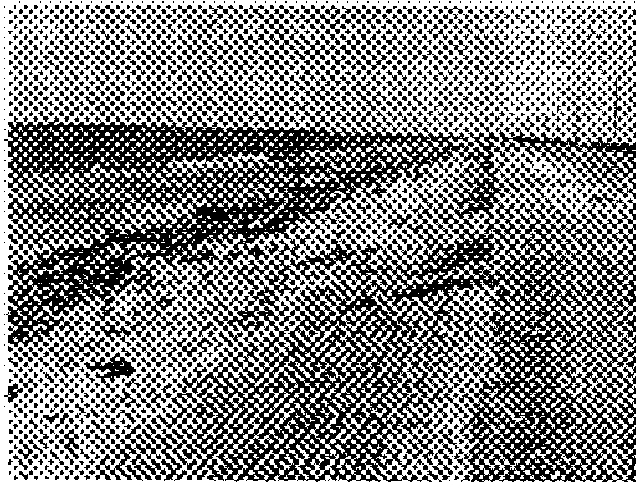

Figure 15. Gobi block revetment, Holly Beach, LA

as any differential settlement beneath the blocks makes them susceptible to overturning under wave action.

*b. Design factors (estimated).*

- (1) Zero-damage wave height is 2 ft.
- (2) Wave runup potential is 90 percent of smooth slope runup.

(3) Wave reflection potential is high.

*c. Prototype installation (Figures B-17 and B-18).* Well-documented in the final report on the Shoreline Erosion Control Demonstration Program (Section 54) is an example of a Turfblock revetment at Port Wing, WI, on Lake Superior. Completed early in November 1978, it immediately experienced greater than design wave conditions. Large waves overtopped the structure, and considerable displacement and settling of the blocks occurred. Breaking wave heights during the storm were estimated to be greater than 6 ft. The most likely cause of failure was uncompacted fill material that contained large boulders. Consolidation of this material after construction was completed may have subjected the blocks to differential settlement. Blocks left resting on boulders became tilted and vulnerable to overturning. Failure may have begun with a few isolated blocks and then quickly spread throughout the revetment. The blocks seem to be sufficiently heavy because they were not displaced very far from their initial positions.

**B-11. Nami Rings**

*a. General.* The Nami Ring is a patented concrete block shaped like a short section of pipe, 2.5 ft in diameter by 1 ft in height, which weighs 240 lb. The rings are placed side-by-side on a slope over a filter.

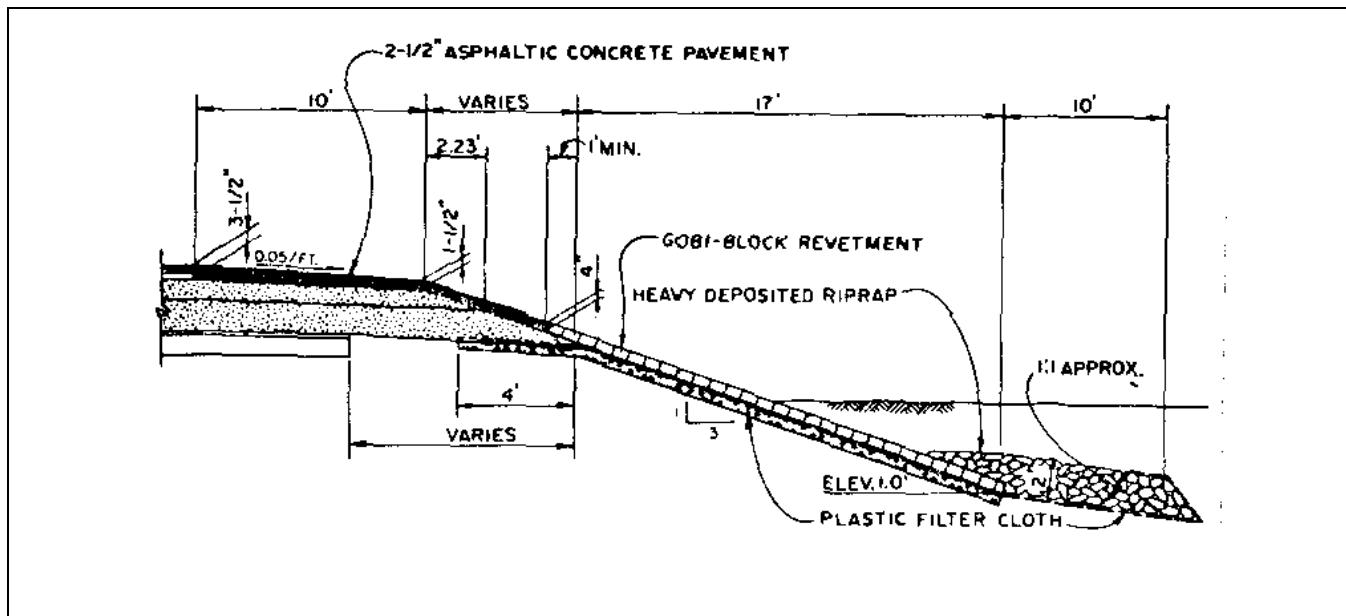

Figure B-16. Gobi block revetment cross section



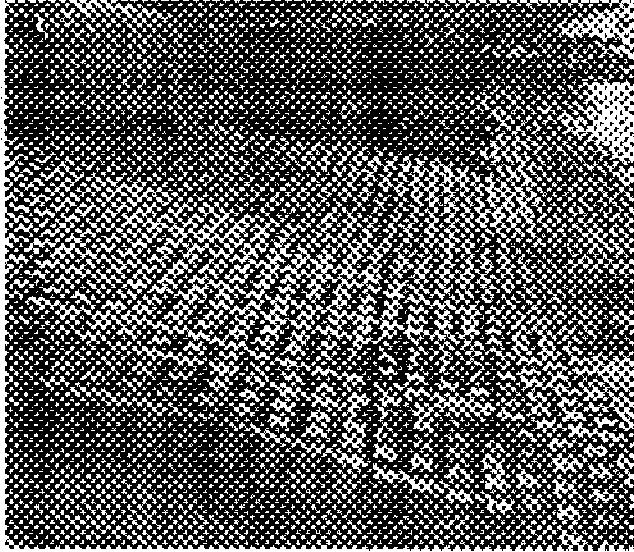

Figure B-17. Turfblock revetment, Port Wing, WI

performance has been observed when the rings are joined together with tie rods. Sand or gravel caught in the wave turbulence tends to be deposited inside the rings and in the voids between adjacent rings, adding to the stability of the section and protecting the filter cloth. Because of their shape, Nami Rings are susceptible to severe abrasion and damage by waterborne cobbles and, therefore, should be used primarily in sandy environments.

b. Design factors (estimated).

- (1) Zero-damage wave height is 3 ft.
- (2) Wave runup potential is 50 to 90 percent of smooth slope runup.
- (3) Wave reflection potential is medium to high.

c. Prototype installation (Figures B-19 and B-20).

A fairly well-documented site (final report on the Shoreline Erosion Control Demonstration Program) is at Little Girls Point, MI. on Lake Superior. A 300-ft Nami Ring revetment was placed there in 1974. The revetment was intended as toe protection for an eroding bluff and was to be installed on a 1V on 1.5H graded slope along the beach at the bluff's base. Regrading was never done, and the revetment was installed on the existing beach without excavating the toe to LWD. The number of blocks was insufficient. The revetment was too low to prevent significant overtopping. The rings were susceptible to waterborne debris. Many were shattered by high waves. Their ability to trap sand is impressive and this protective mantle tends to shield the rings from damage. The filled rings offer a considerably smooth surface, however, so that runup increases with age. Field surveys in 1979 showed that the revetment was almost entirely filled with littoral material and was no longer functioning as originally intended. Better performance would have occurred with a properly graded slope, toe protection, and better

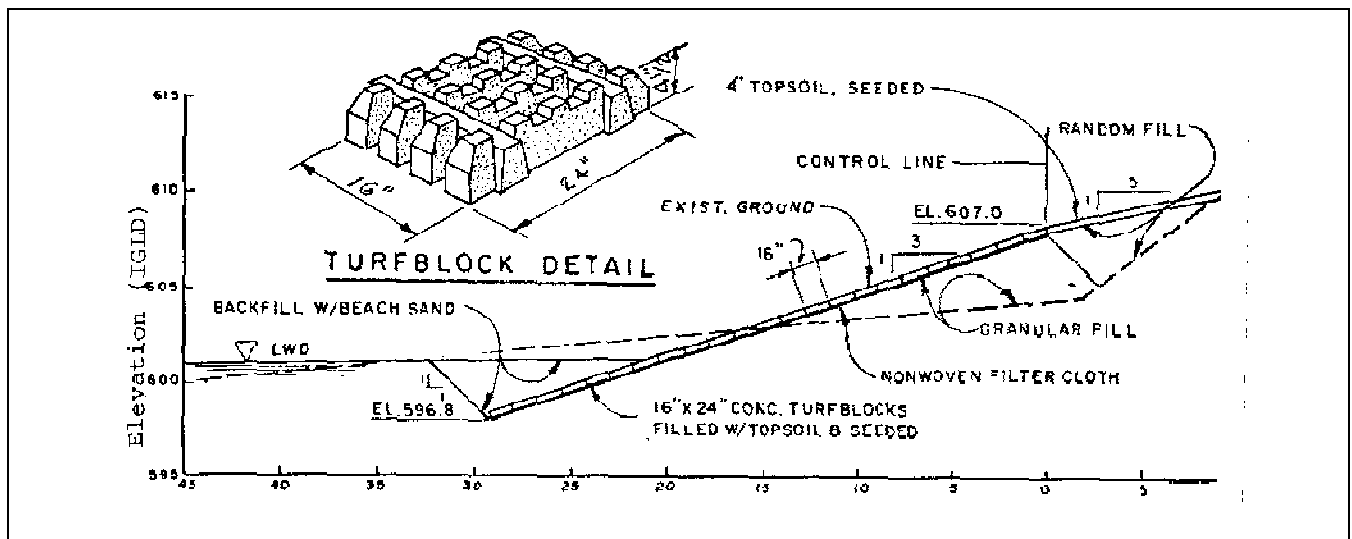

Figure B-18. Turfblock revetment cross section

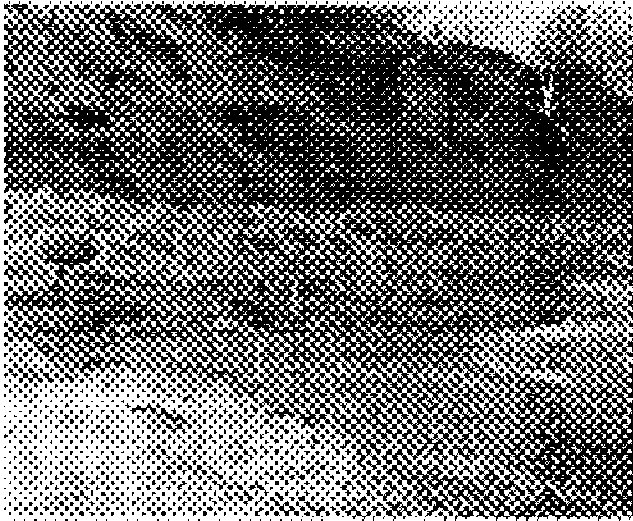

Figure B-19. Nami Ring revetment, Little Girls Point, MI

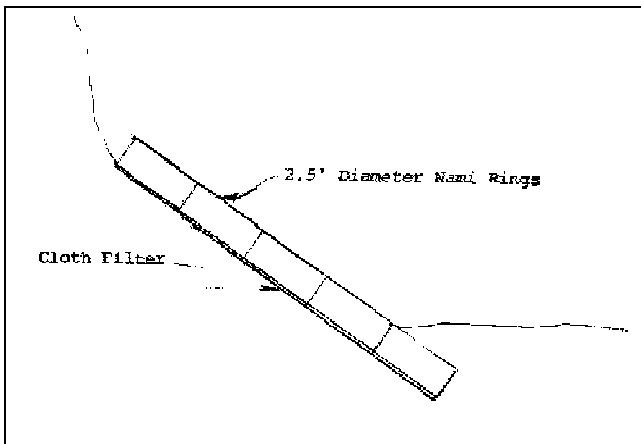

Figure B-20. Nami Ring revetment cross section

filtering. Improved filtering is especially important because the initial failure occurred in the half of the revetment that had no filter and then spread to the other half that was underlain with filter cloth.

### B-12. Concrete construction blocks

*a. General.* Standard concrete construction blocks can be hand placed on a filter cloth with their long axes perpendicular to the shoreline and the hollows vertical. Their general availability is a primary advantage, but they are highly susceptible to theft. They form a deep, tightly fitting section which is stable provided the toe and flanks are adequately protected. The failure has been the most

prominent problem with concrete construction block revetments tested at prototype scale (Giles 1978). Another disadvantage is that standard concrete for building construction is not sufficiently durable to provide more than a few years service in a marine environment. Special concrete mixes should be used when possible.

*b. Design factors (estimated).*

- (1) Zero-damage wave height is 4 ft.
- (2) Wave runup potential is 80 to 90 percent of smooth slope runup.
- (3) Wave reflection potential is high.

*c. Prototype installations (Figures B-21 and B-22).*

Concrete block revetments have been built throughout the United States (Shoreline Erosion Control Demonstration Program Report). Monitoring data are available for one built along the north shore of Lake Pontchartrain in Louisiana. Constructed in November 1979, it utilized standard 8- by 16-in. blocks placed hollows-up on a woven filter cloth. In January 1980, a section of blocks was stolen from the revetment, a reason for caution when using common materials such as these. In April 1980, a storm dislodged several blocks, and the toe settled unevenly into the lake bottom. During repair efforts, the blocks were inadvertently placed with their long axes parallel to shore; consequently, they were readily displaced again by large waves. This displacement suggests that greater stability may be available when blocks are placed with their long axes perpendicular to shore. Overall, the structure performed adequately in the sheltered, mild wave climate area of this site.

### B-13. Concrete Control Blocks

*a. General.* Concrete control blocks come in various sizes and are similar to standard concrete construction blocks except that protrusions in the block ends provide a tongue-and-groove interlock between units. Designed to be hand placed on a filter cloth with the cells vertical, the blocks can be aligned with their long axes parallel to shore, but optimum performance probably results from placement perpendicular to the water's edge.

*b. Design factors (estimated).*

- (1) Zero-damage wave height is 5 ft.
- (2) Wave runup potential is 50 to 90 percent of smooth slope runup.



Figure B-21. Concrete construction block revetment, Fontainebleau, State Park, LA

(3) Wave reflection potential is medium to high.

c. *Prototype installation* (Figures B-23, B-24, and B-25). Two small revetments using control blocks were constructed at Port Wing, WI, on Lake Superior in October 1978 (Shoreline Erosion Control Demonstration Program Report). One revetment used 10-in. by 16-in. blocks (8 in. deep), and the other used smaller 8-in. by 16-in. blocks (also 8 in. deep). In both cases the long axes were placed parallel to the waterline and utilized a simple buried toe. The devices performed well through 1982 and withstood several episodes of large waves, including the one in November 1978 that destroyed the neighboring Turfblock revetment (paragraph B-10). Simple burial of the toe appears to be an inadequate treatment

at this site, and progressive unravelling of the revetment from the toe was evident by 1982. Also, the concrete used in manufacturing the blocks appears inadequate to withstand abrasion and freeze-thaw cycles at the site. The blocks near the waterline were clearly showing signs of deterioration by 1979 as shown in Figure B-23.

#### B-14. Shiplap Blocks

a. *General.* Shiplap blocks are formed by joining standard or other size patio blocks with an epoxy adhesive. The resulting weight of the units depends on the size of the basic blocks used. Table B-1 lists the weights for several block sizes.

b. *Design factors.*

(1) Zero-damage wave heights.

Small blocks: 4 ft (Hall and Jachowski 1964).

Large blocks: 5 ft (estimated).

(2) Wave runup potential is estimated to be 90 to 100 percent of smooth slope runup.

(3) Wave reflection potential is estimated to be high.

c. *Prototype installations.*

(1) Small blocks (Figures B-26 and B-27). The first widely known shiplap block revetment was the one built on the east bank of the Patuxent River opposite Benedict, MD. Described in Hall and Jachowski (1964), it

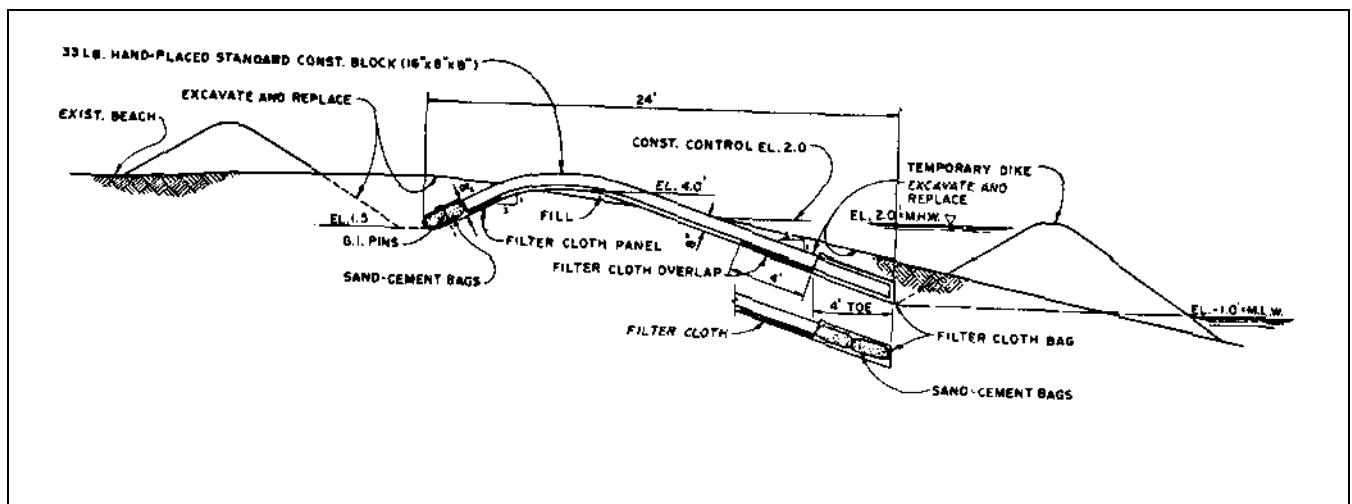

Figure B-22. Concrete construction block revetment cross section

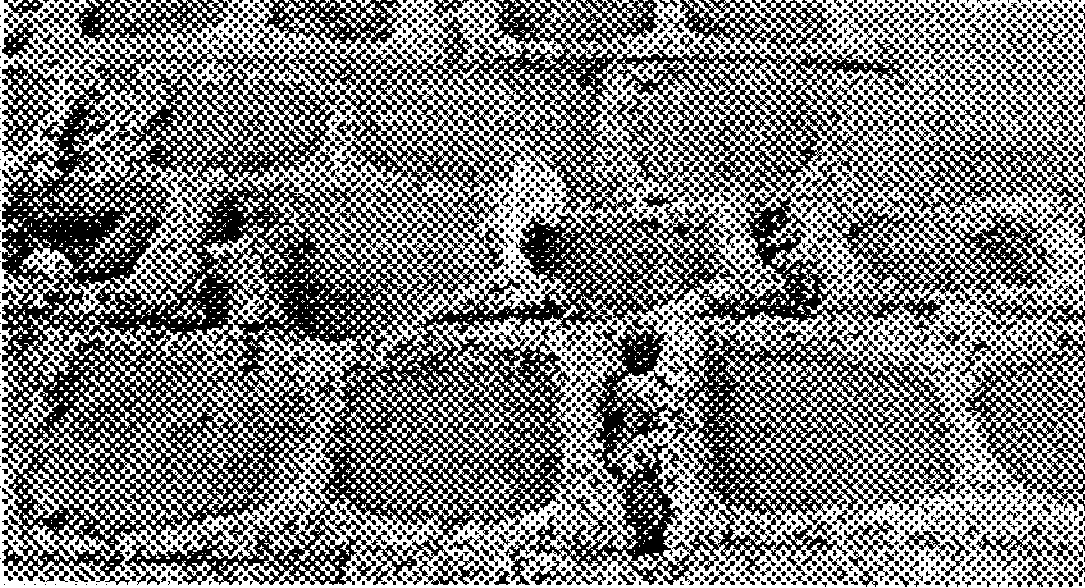

Figure B-23. Detail of erosion of concrete control blocks



Figure B-24. Concrete control block revetment, Port Wing, WI

consisted of units of two 8- by 16- by 2-in. blocks glued together at a 3-in. offset in two directions. The structure was completed in July 1962, and provided long service. A similar revetment was constructed in 1964 near the mouth of the Choptank River in the vicinity of Oxford, MD (Hall 1967). Model tests at prototype scale, using similar 18- by 18- by 3-in. blocks revealed the need for spacers or slots to relieve excess hydrostatic pressures behind the blocks.

(2) Large blocks. A large revetment was constructed at Jupiter Island, FL, with alternating 3-ft square, 10- and 14-in. thick blocks (Wilder and Koller 1971). This revetment was later damaged during a storm with failure occurring either due to a weakness at the toe or through inadequate filtering or hydrostatic pressure relief.

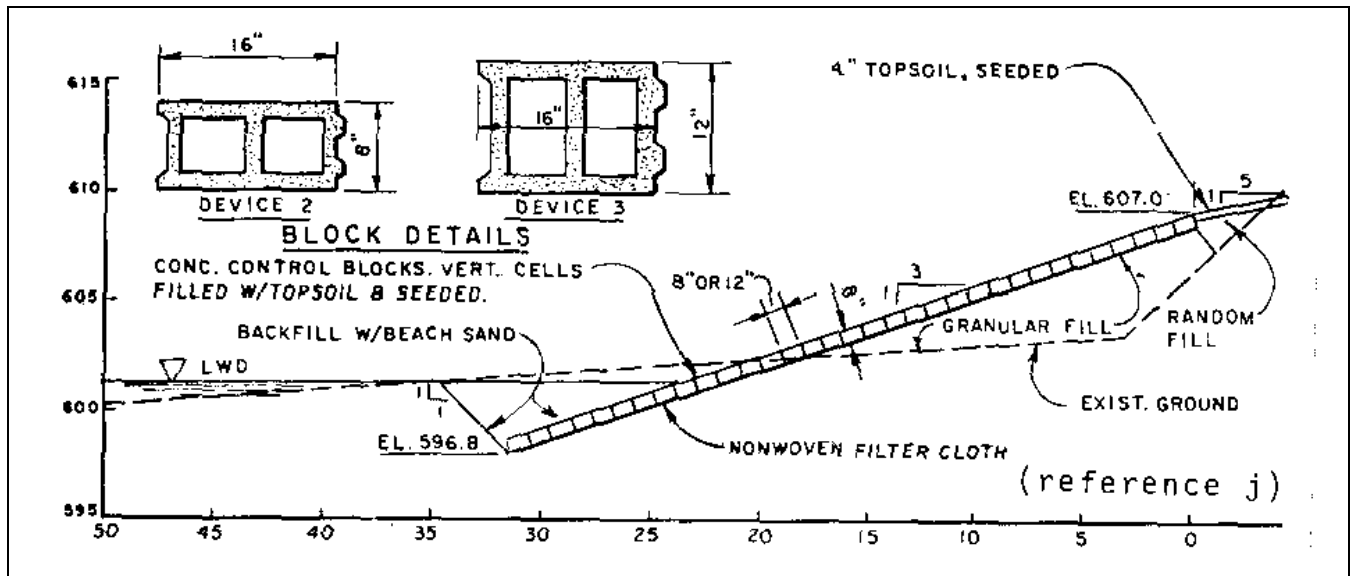

Figure B-25. Concrete control block revetment cross section

Table B-1  
Shiplap Block Weights

Two-Block Glued Unit in.	Weight lb
8 x 16 x 4	40
18 x 18 x 6	160
36 x 36 x 20	2,100
36 x 36 x 28	2,940

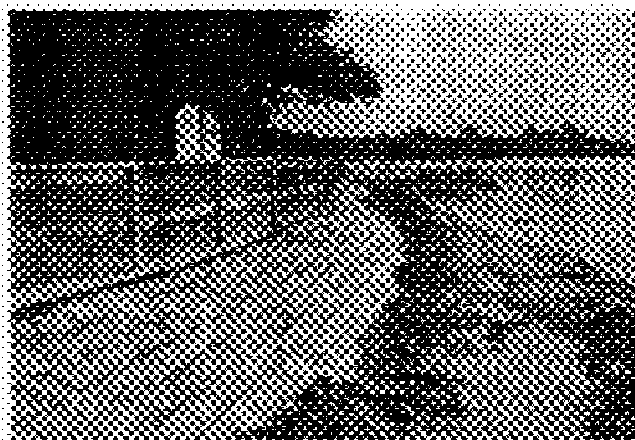

Figure B-26. Shiplap block revetment, Benedict, MD

### B-15. Lok-Gard Blocks

a. *General.* Lok-Gard blocks are joined with a tongue-and-groove system. The patented 80-lb units are designed for hand placement with their long axes perpendicular to shore. The finished revetment has a smooth surface which results in high runup and overtopping potential.

b. *Design factors (estimated).*

Zero-damage wave height is 4 ft.

Wave runup potential is 100 percent of smooth slope runup.

Wave reflection potential is high.

c. *Prototype installations.* A Lok-Gard revetment was constructed on Tilghman Island at Cedarhurst, MD, in the 1960's (Mohl and Brown 1967). Eight hundred feet of shoreline were protected with blocks placed on a 1V:2H slope. The estimated storm wave height at the site was 5 ft which is approximately at the upper stability range for these blocks (Hall 1967). Relief of hydrostatic pressure is critical, so only blocks with pressure relief slots along one side should be used. A similar revetment was constructed along the Jensen Beach Causeway in

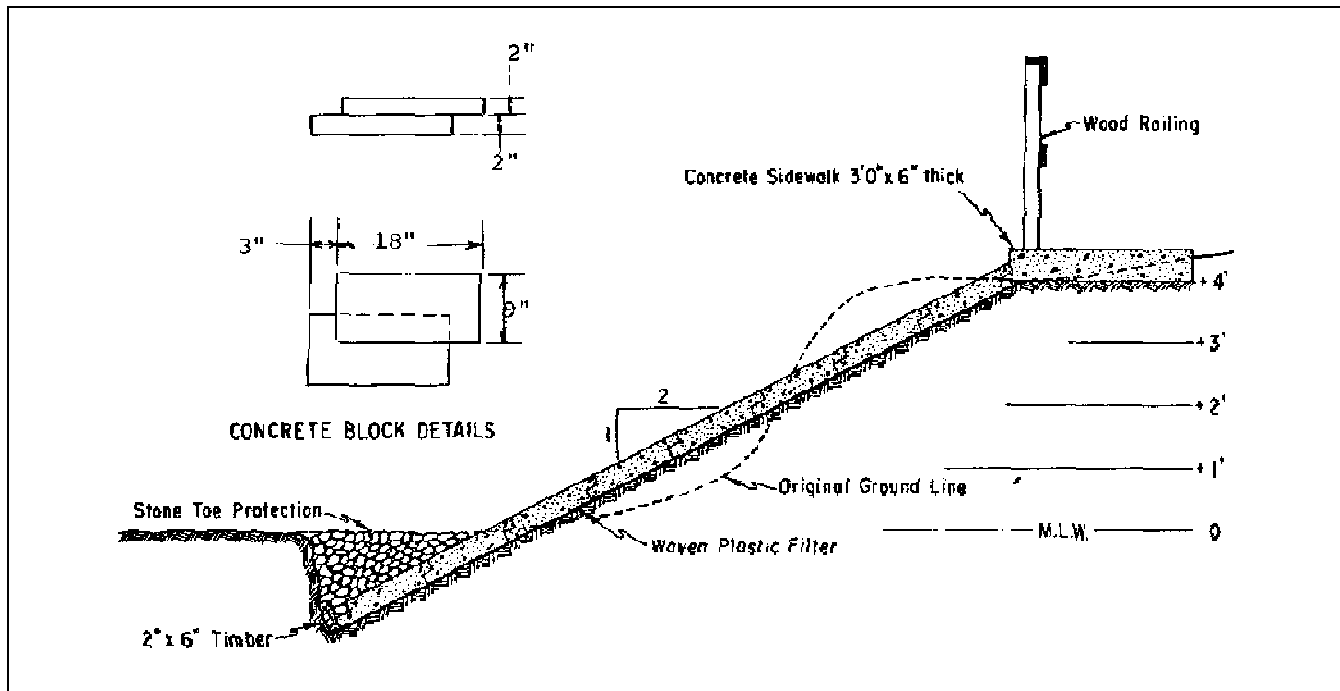

Figure B-27. Shiplap block revetment cross section

Florida in 1980 (final report on the Shoreline Erosion Control Demonstration Program) (Figures B-28 and B-29). The site is sheltered, and maximum expected waves are on the order of 3 ft high. Performance was satisfactory through 1982.

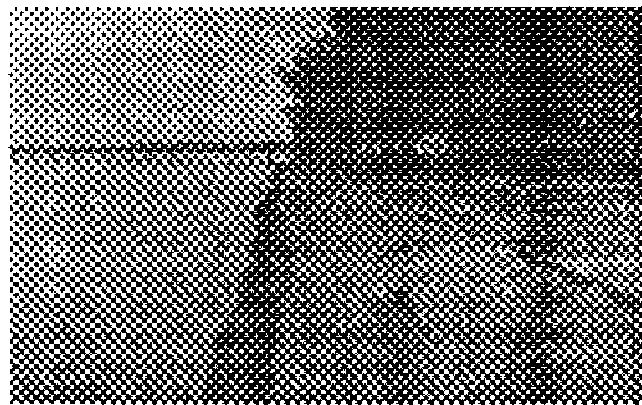

Figure B-28. Lok-Gard block revetment, Jensen Beach Causeway, FL

### B-16. Terrafix Blocks

a. *General.* Terrafix blocks are patented units that are joined with a mortise and tenon system and have cone-shaped projections which fit holes in the bottom of

the adjacent blocks. In addition, holes through the center of each block allow for stainless steel wire connection of many individual blocks. The uniform interlocking of the 50-lb units creates a neat, clean appearance.

#### b. *Design factors (estimated).*

- (1) Zero-damage wave height is 5 ft.
- (2) Wave runup potential is 90 percent of smooth slope runup.
- (3) Wave reflection potential is high.

c. *Prototype installations (Figures B-30 and B-31).* Specific details about field installations and locations are unknown. A photograph of a site at Two Mile, FL, and a typical Terrafix revetment section are shown.

### B-17. Fabric Containers

Several manufacturers produce bags and mats in various sizes and fabrics that can be used for revetment construction when filled either with sand or a lean concrete mixture. Bags can be placed directly on the slope in a single layer, or they can be stacked in a multiple layer running up the slope. Mattresses are designed to be laid flat on a

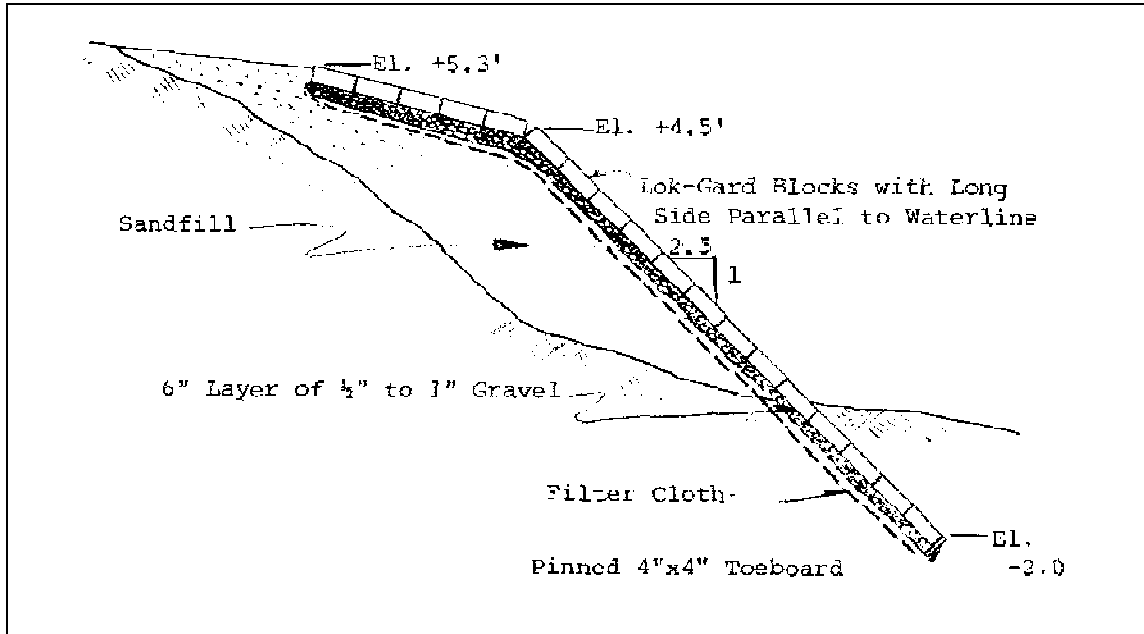

Figure B-29. Lok-Gard block revetment cross section



Figure B-30. Terrafix block revetment, Two Mile, FL

slope. The advantages of bag revetments are their ease of construction and moderate initial cost. Sand-filled units are relatively flexible and can be repaired easily. Their disadvantages are susceptibility to vandalism, damage from waterborne debris, and degradation under ultraviolet

light. Concrete fill eliminates these problems at a high cost and loss of structural flexibility. Placement should always be on a stable slope. A stacked bag revetment can be placed on a steeper slope than a blanket revetment or

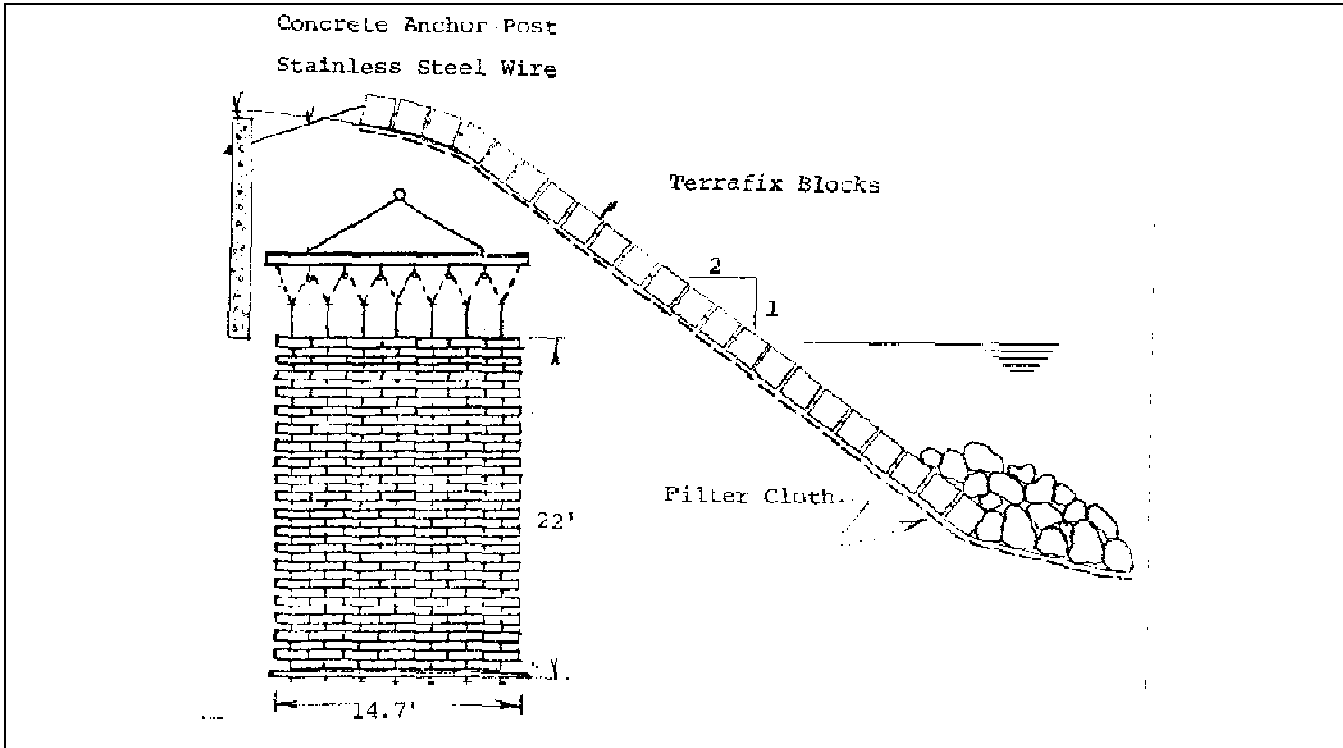

Figure B-31. Terrafix block revetment cross section

mattress, but in no case should the slope exceed IV on 1.5 H.

### B-18. Mattresses

a. *General.* Mattresses are designed for placement directly on a prepared slope. Laid in place when empty, they are joined together and then pumped full of concrete. This results in a mass of pillow-like concrete sections with regularly spaced filter meshes for hydrostatic pressure relief. Installation should always be in accordance with the manufacturer's recommendations.

b. *Design factors (estimated).*

- (1) Zero-damage wave height is 3 ft.
- (2) Wave runup potential is 95 to 100 percent of smooth slope runup.
- (3) Wave reflection potential is high.

c. *Prototype installation (Figures B-32 and B-33).* The best example of a concrete mattress subjected to wave action is the upstream face of Allegheny Reservoir

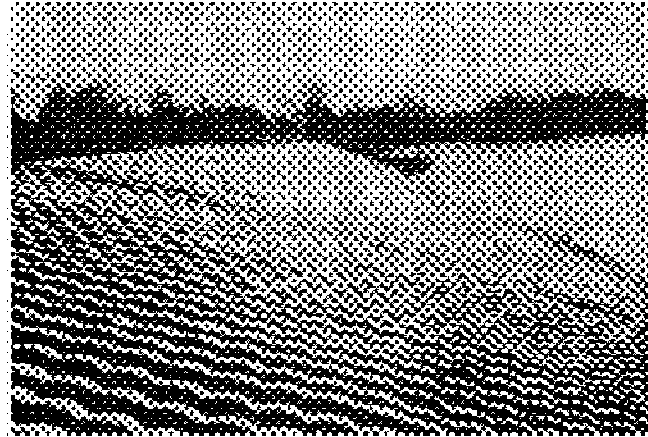

Figure B-32. Fabriform revetment, location unknown

(Kinzu Dam) in northern Pennsylvania and southern New York. Built in 1968, the Fabriform nylon mat was placed 53 ft down a 1-on-1.5-slope and, through 1980, was functioning as designed. The panels were anchored in a trench about 7 ft above the high water level. A large portion of the lower part of the revetment was constructed with the nylon fabric forms under water. Because the mattress is essentially a collection of discrete concrete



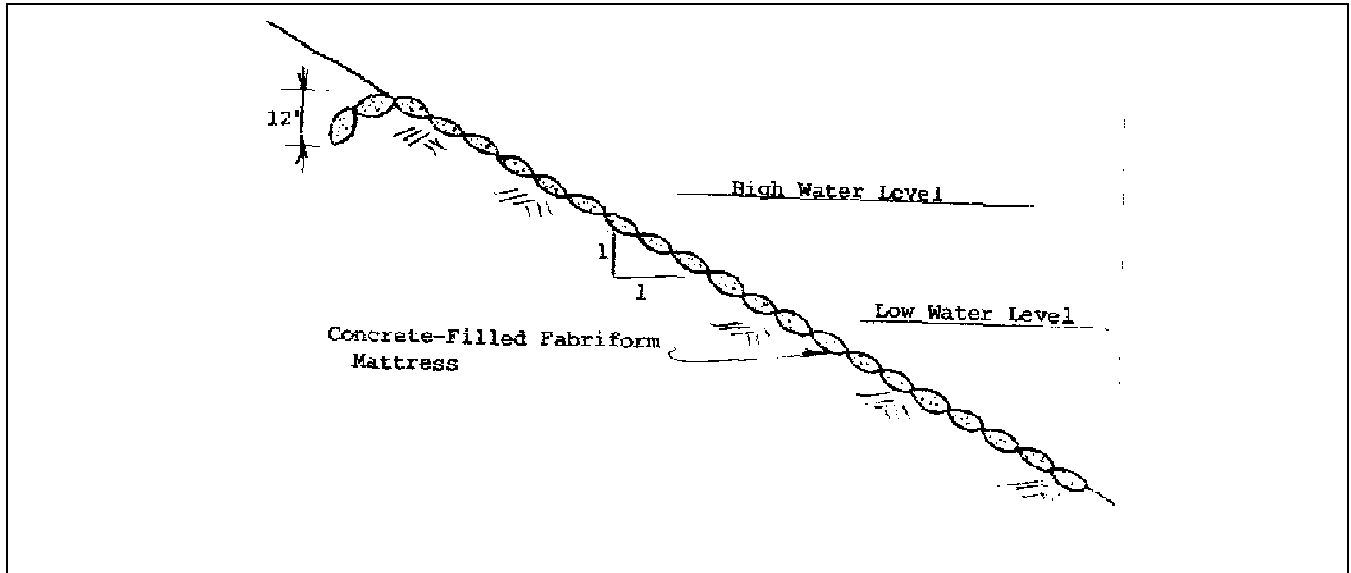

Figure B-33. Fabriform revetment cross section

masses that are joined together, there is a danger of cracking and breaking of the mat under differential settlement. Also, the mats may be damaged by heavy floating debris.

### B-19. Bags

*a. Blanket revetment.* One or two layers of bags placed directly on a slope are suitable for temporary, emergency, or other short-term protection. The smooth, rounded contours of the bags present an interlocking problem, and they slide easily. For improved stability, the bags should be kept underfilled to create a flatter shape with a greater surface contact area.

*b. Stacked-bag revetment.* This type of structure consists of bags that are stacked pyramid-fashion at the base of a slope or bluff. The long axes of the bags should be parallel to shore, and the joints should be offset as in brickwork. Grout or concrete-filled bags can be further stabilized with steel rods driven through the bags. The same precautions about underfilling the bags for greater stability should be observed with this kind of structure. In addition, sufficient space should be provided between the structure and the bluff to preclude damages in the event of bluff slumping and to provide an apron to absorb wave energy that overtops the structure thereby protecting the toe of the bank from scour.

*c. Design factors (estimated).*

(1) Zero-damage wave heights:

1.5 ft for small bag blankets.

2.0 ft for large bag blankets.

2.0 ft for small bag stacks.

3.0 ft for large bag stacks.

(2) Wave runup potential for:

Blankets is 90 percent of smooth slope runup.

Stacked bags is 80 percent of smooth slope runup.

(3) Wave reflection potential is high.

*d. Prototype installation.*

(1) General description (Figures B-34 and B-35). An excellent example of a bag revetment is one constructed in June 1978 at Oak Harbor, WA, on Puget Sound. The structure was built in two halves, one using ready-mix concrete in burlap bags and the other using a commonly available dry sand-cement mix in paper sacks. The dry-mix sacks in each tier were systematically punctured with pitch forks and flooded with fresh water from a

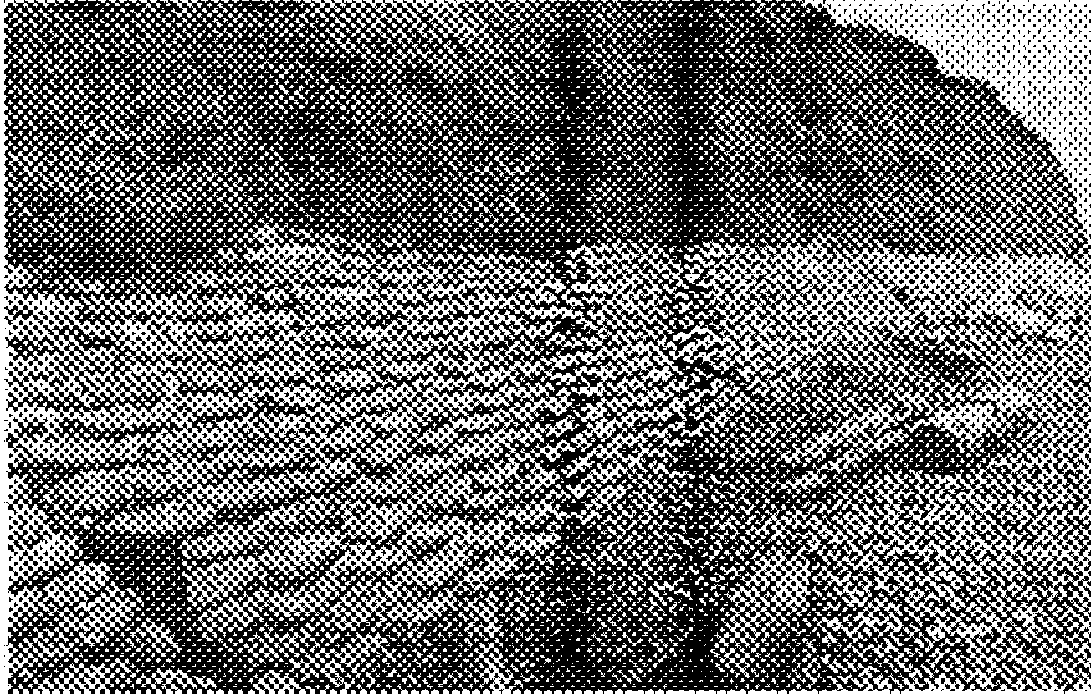

Figure B-34. Bag revetment at Oak Harbor, WA

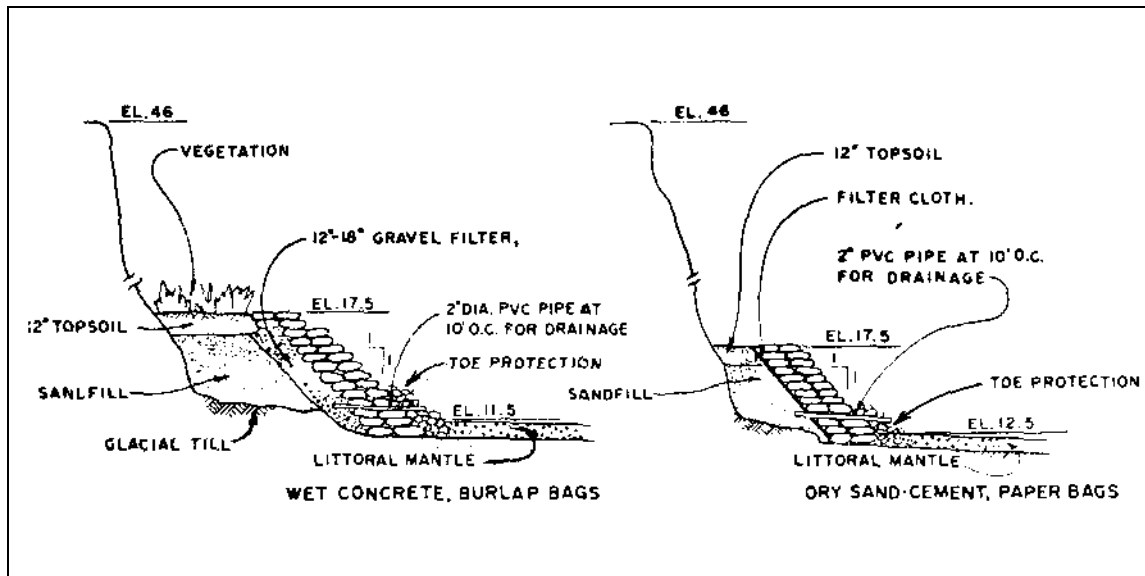

Figure B-35. Bag revetment cross section

garden hose before the next tier was placed. Note from the cross sections that a gravel filter was used behind the burlap bags and a filter cloth behind the paper sacks. Also, PVC drain pipes were provided at 10-ft centers for hydrostatic pressure relief. The landward ends of these

pipes were wrapped with filter cloth to prevent passage of fines through the drain pipes.

(2) Performance. Several severe storms have struck the site with breaking wave heights of 3.5 ft or more.

Neither structure suffered significant damages as a result of these storms, but the toe rock was displaced. This displacement eventually led to a partial unravelling of the burlap bag structure proceeding from the toe at a point of especially severe wave attack. The burlap bags, however, did appear to nest better than the paper sacks, and the ready-mix concrete will probably provide a longer service life than the dry sand-cement mix. Overall, however, the bag revetments proved to be an excellent and economical solution at this site.

## B-20. Gabions

*a. General.* Gabions are rectangular baskets or mattresses made of galvanized, and sometimes also PVC-coated, steel wire in a hexagonal mesh. Subdivided into approximately equally sized cells, standard gabion baskets are 3 ft wide and available in lengths of 6, 9, and 12 ft and thicknesses of 1, 1.5, and 3 ft. Mattresses are either 9 or 12 in. thick. The standard baskets are generally preferred over mattresses because they are fabricated of heavier wire (approximately 11 gauge versus approximately 13-1/2 gauge). At the jobsite, the baskets are unfolded and assembled by lacing the edges together with steel wire. The individual baskets are then wired together and filled with 4- to 8-in.-diam stone. The lids are finally closed and laced to the baskets, forming a large, heavy mass.

*b. Advantages.* One advantage of a gabion structure is that it can be built without heavy equipment. Gabions are flexible and can maintain their function even if the foundation settles. They can be repaired by opening the baskets, refilling them, and then wiring them shut again. They can also be repaired with shotcrete, although care must be taken to ensure relief of hydrostatic pressures.

*c. Disadvantages.* One disadvantage of a gabion structure is that the baskets may be opened by wave action. Also, since structural performance depends on the continuity of the wire mesh, abrasion and damage to the PVC coating can lead to rapid corrosion of the wire and failure of the baskets. For that reason, the baskets should be tightly packed to minimize movement of the interior stone and subsequent damage to the wire. Rusted and broken wire baskets also pose a safety hazard. Gabion structures require periodic inspections so that repairs are made before serious damage occurs.

*d. Design precautions.* To ensure best performance, use properly sized filler rock. Interior liners or sandbags to contain smaller sized material are not recommended. The baskets should be filled tightly to prevent movement

of the stone, and they should be refilled as necessary to maintain tight packing. Gabions should not be used where bombardment by waterborne debris or cobbles is present or where foot traffic across them is expected. Baskets must be filled in place to allow them to be laced to adjacent units prior to filling.

*e. Design factors (estimated).*

(1) Zero-damage wave height is 5 ft.

(2) Wave runup potential is 80 percent of smooth slope runup.

(3) Wave reflection potential is high.

*f. Prototype installation (Figures B-36 and B-37).*

A gabion revetment was constructed at Oak Harbor, WA, in June 1978 (final report on the Shoreline Erosion Control Demonstration Program). Note that half of the revetment was placed on a gravel filter, and half was placed on filter cloth. The structure weathered several storms in the ensuing 2 years and suffered little damage attributable to the gabions themselves (backfill was lost in several areas where no filter had been placed). Performance was adequate at this site where breaking wave heights probably did not exceed 3.5 to 4.0 ft.

## B-21. Steel Fuel Barrels

*a. General.* This type of revetment is limited to remote areas where there is an abundance of used fuel barrels of little salvageable value. Due to rapid corrosion of the barrels in warm water, the system is reliable only in Arctic regions. The barrels should be completely filled with coarse granular material to preclude damage by floe ice and debris, and the critical seaward barrels should be capped with concrete. Also, partial burial of the barrels increases stability.

*b. Design factors (estimated).*

(1) Zero-damage wave height is 3 ft.

(2) Wave runup potential is 80 percent of smooth slope runup.

(3) Wave reflection potential is medium to high.

*c. Prototype installation (Figures B-38 and B-39).*

A barrel revetment was constructed at Kotzebue, AK, off the Arctic Ocean during the summers of 1978 and 1979



Figure B-36. Gabion revetment, Oak Harbor, WA

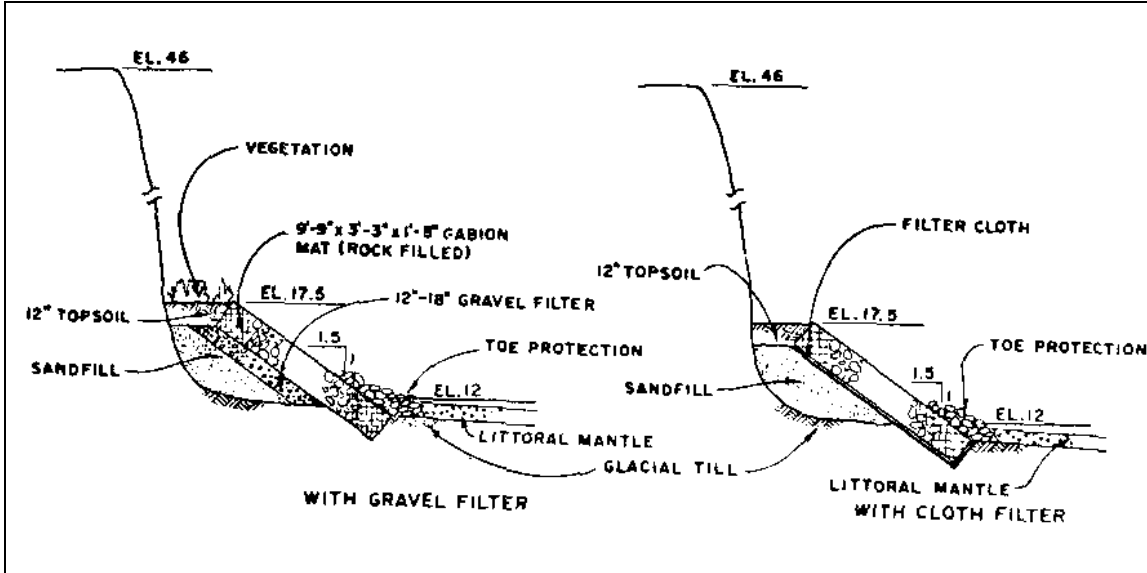

Figure B-37. Gabion revetment cross section

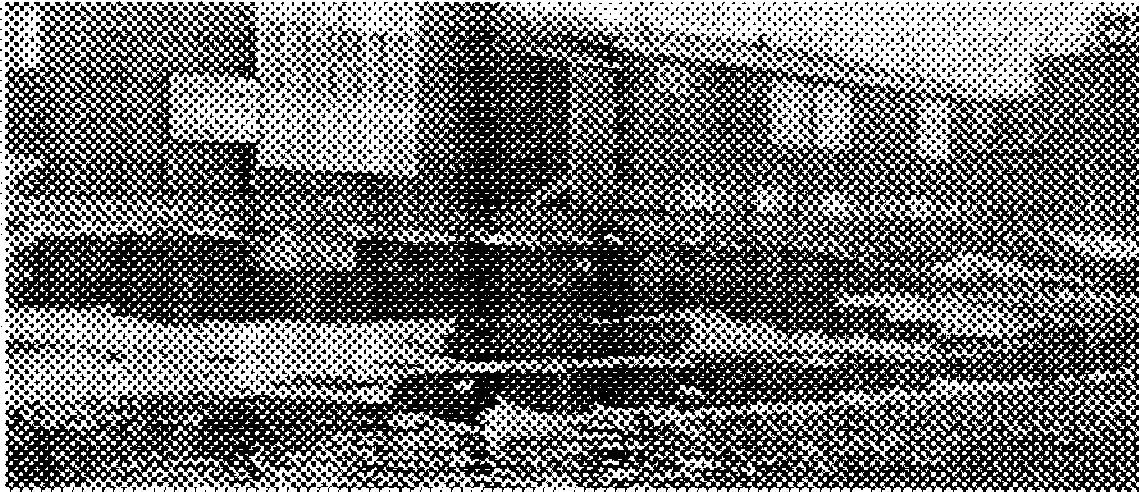

Figure B-38. Steel fuel barrel revetment, Kotzebue, AK

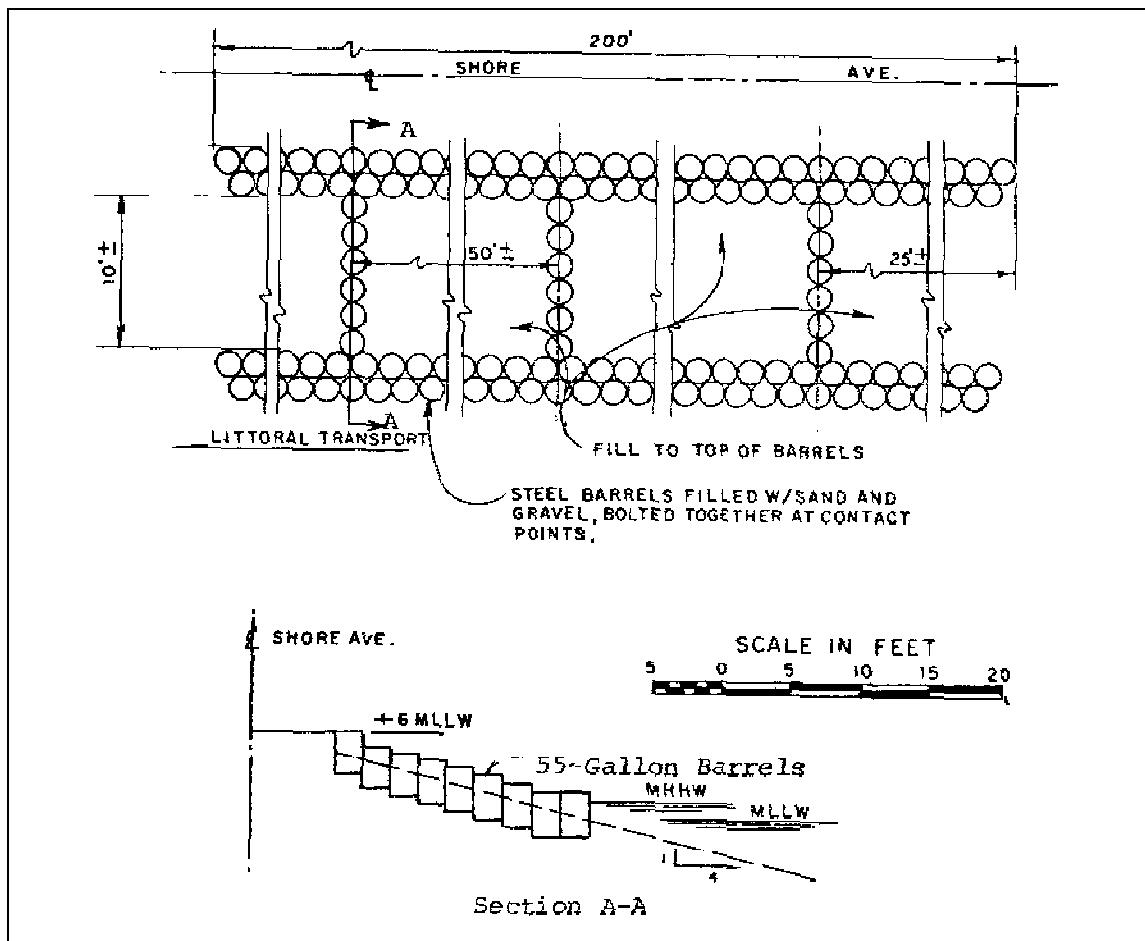

Figure B-39. Steel fuel barrel revetment plan and cross section

(final report on Shoreline Erosion Control Demonstration Program). Performance was acceptable, although wave-driven ice floes damaged some of the barrels at the seaward end of the structure. Gravel fill within the barrels limited the damages, but retention of this fill was difficult without the use of expensive concrete caps or other positive means.

## **B-22. Fabric**

*a. General.* Revetments using filter cloth or other fabrics as the slope's armor layer have not been successful. They do have some potential, however, as expedient, emergency devices when speed of construction or lack of suitable armor materials necessitate their use. The fabric can be used alone, or it can be combined with some form of ballast to add stability.

*b. Design factors (estimated).*

- (1) Zero-damage wave height is 0.5 to 1 ft.
- (2) Wave runup potential is 100 percent of smooth slope runup.
- (3) Wave reflection potential is high.

*c. Prototype installations (Figures B-40 and B-41).* Two filter cloth revetments that have been documented were built at Fontainebleau State Park, LA, in the fall of 1979 (final report on Shoreline Erosion Control Demonstration Program). The first utilized a filter cloth with large pre-sewn ballast pockets to help hold the filter cloth panel in place. The outer rows of pockets were filled with bags of sand-cement and the interior pockets were filled with shell. The entire cloth was covered with 6 in. of shell and then with 6 in. of topsoil which was seeded with Bermuda grass and fertilized. The other revetment was constructed with the same cloth but with pre-sewn loops to which ballast (115-lb blocks) could be attached to anchor the cloth. Instead of using the loops, however, the blocks were anchored to the cloth with galvanized iron pins driven through the holes in the blocks. Performance of both revetments was poor, and neither form of anchoring was sufficient for stability for a period longer than a few months.

## **B-23. Concrete Slabs**

*a. General.* Large concrete slabs salvaged from demolition work have often been used for shore protection. Placed directly on a slope, they provide a massive, heavy structure that is not easily moved by wave action.

Failures have been numerous, however, usually due to improper provision for filtering, inadequate toe protection, and lack of flank protection.

*b. Design factors (estimated).*

- (1) Zero-damage wave height is 1 to 5 ft depending on the thickness of the slabs.
- (2) Wave runup potential is 100 percent of smooth slope runup.
- (3) Wave reflection potential is high.

*c. Prototype installation (Figures B-42 and B-43).* A concrete slab revetment constructed at Alameda, CA, in November 1978, is illustrative of the problems commonly experienced with this kind of structure (final report on Shoreline Erosion Control Demonstration Program). The structure was placed on a sand fill at a 1-on-0.6 slope with an underlying nonwoven filter cloth. The slabs, obtained from a building demolition site, were hoisted into place by crane; and one slab was cracked during this operation. The structure failed under wave action because of inadequate toe protection, flanking, failure of the filter cloth under the shifting slabs, and inherent instability of the underlying 60-deg slope.

## **B-24. Soil Cement**

*a. General.* Soil cement is a mixture of portland cement, water, and soil. When compacted while moist, it forms a hard, durable material with properties similar to concrete and rock. A typical mixture may contain 7 to 14 percent portland cement and 10 percent water by weight of dry soil. Use of soil cement in shore protection is discussed in Wilder and Dinchak (1979).

*b. Design factors.*

- (1) Zero-damage wave height depends on layer thickness and quality control during construction up to an estimated 10-ft maximum.
- (2) Wave runup potential is 80 to 90 percent of smooth slope runup (Stoa 1979).
- (3) Wave reflection potential is estimated to be high.

*c. Prototype installation (Figures B-44 and B-45).* One of the oldest known soil cement installations in the United States is a test section on the southeast shore of



Figure B-40. Fabric revetments, Fontainebleaus State Park, LA

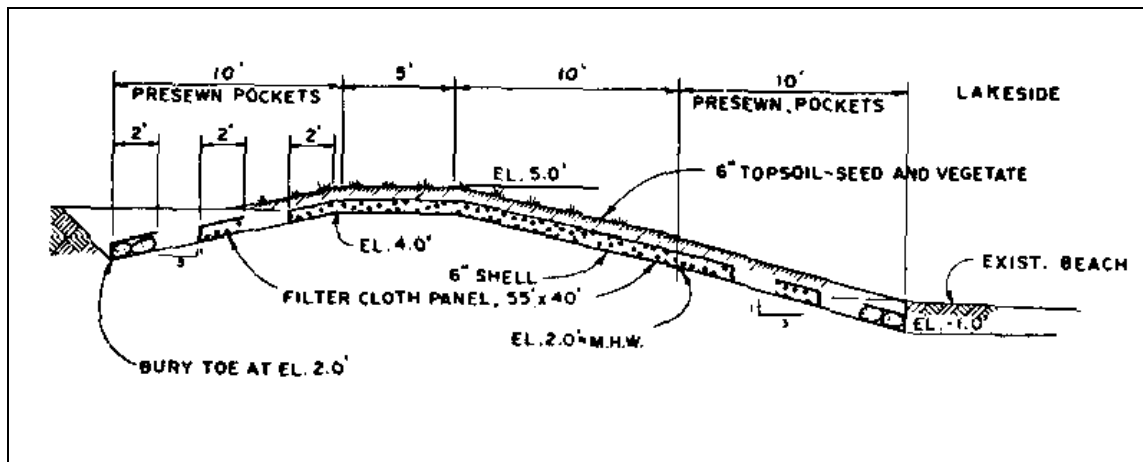

Figure B-41. Fabric revetment cross section

Bonny Reservoir in eastern Colorado. It consists of a series of 6-in.-thick by 7-ft-wide horizontal layers of soil cement with about a 1-on-2 slope to the exposed stairstep face. Constructed in 1951, it remains in good structural condition. At three sites on the north shore of the Gaspé Peninsula, Quebec, 6,000 ft of soil cement revetments, constructed in stairstep fashion, and having 2.5-ft thickness normal to the slope, have successfully withstood repeated attacks by waves up to 10 ft high (measured offshore) since their completion in 1975 (Wilder and Dinchak 1979).

### B-25. Tire Mattresses

*a. General.* Tire mattresses consist of loose or connected scrap tires placed on a filter and filled with a sand-cement or ready-mix concrete ballast. Such structures can be durable, flexible, and inexpensive provided the weight of the filled tires provides adequate stability.

*b. Design factors (estimated).*

- (1) Zero-damage wave height is 1 ft.



Figure B-42. Concrete slab revetment, Alameda, CA

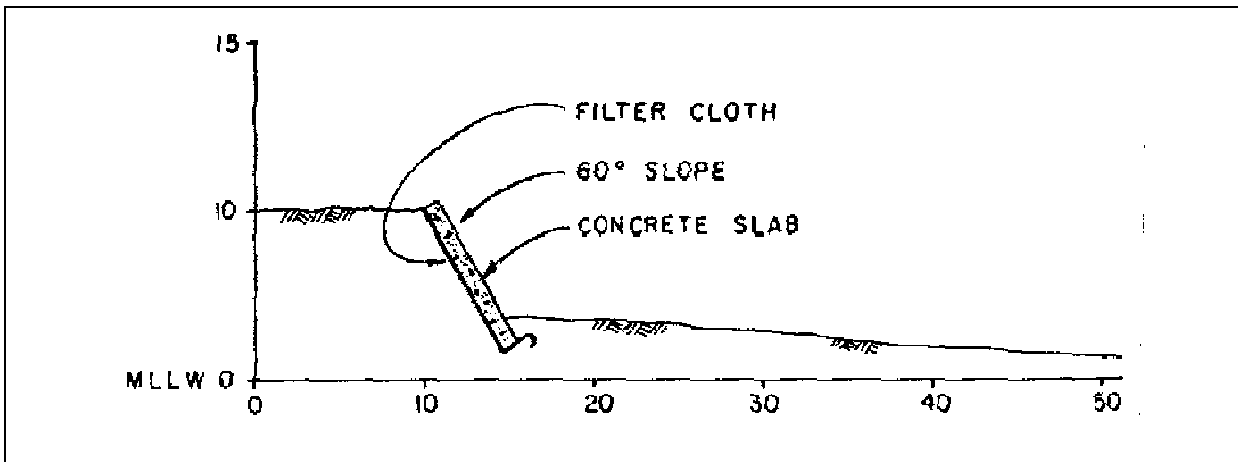

Figure B-43. Concrete slab revetment cross section



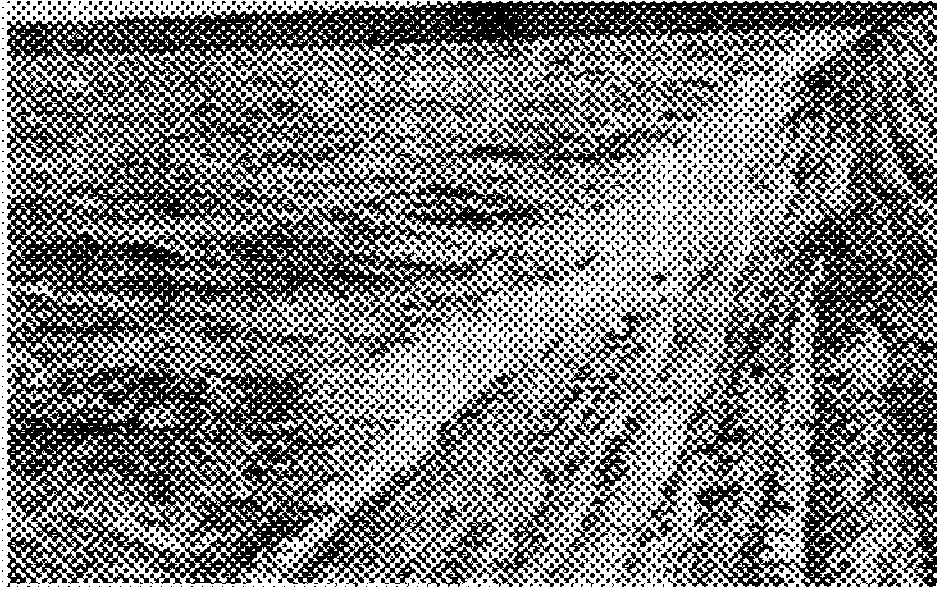

Figure B-44. Soil cement revetment, Bonny Dam, CO

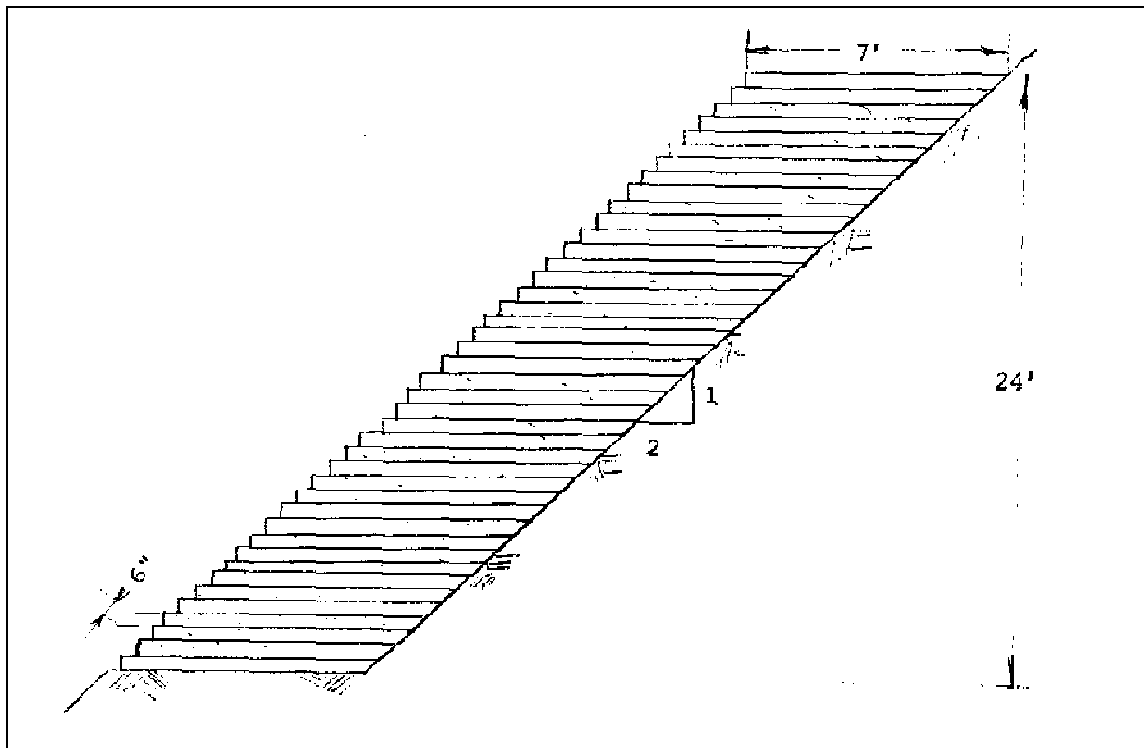

Figure B-45. Soil cement revetment cross section

(2) Wave runup potential is 90 percent of smooth slope runup.

(3) Wave reflection potential is high.

*c. Prototype installation (Figures B-46 and B-47).* A prototype structure was built in October 1979, at Fontainebleau State Park, LA (final report on Shoreline

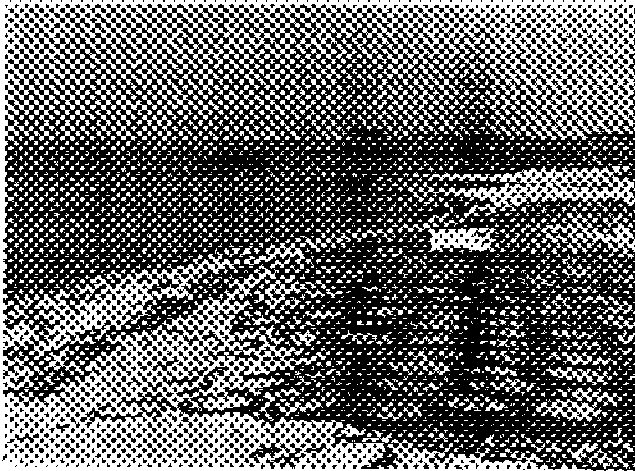

Figure B-46. Tire mattress revetment, Fontainebleau State Park, LA

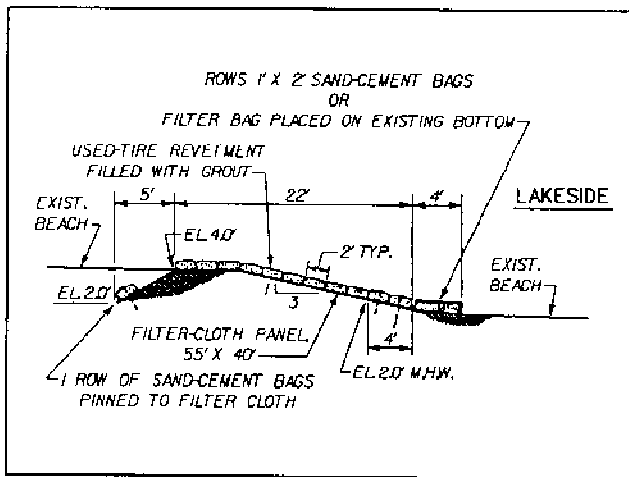

Figure B-47. Tire mattress revetment cross section

Erosion Control Demonstration Program). A filter cloth was placed on a prepared 1-on-3 slope, and two rows of sand-cement bags were placed along the lakeward edge to act as toe protection. The filter cloth was lapped over the bags at the toe, and the first row of tires was placed on this overlap (Dutch toe method). The tires were filled with a dry sand-cement mixture, and the revetment was completed with another row of bags at the crest. The structure remained stable until April 1980 when a storm displaced about 50 percent of the tires, although the structure still continued to function after that. One contributing factor to the failure was the use of dry sand-cement which led to incomplete filling of the tires and significantly reduced the weight per unit.

## B-26. Landing Mats

a. *General.* Mo-Mat is one form of landing mat consisting of 0.625-in.-thick fiberglass molded into a waffle pattern with a weight of about 1 lb/ft<sup>2</sup>. It may be used as revetment armoring in mild wave climates, given adequate toe protection and filtering, along with a suitable method of strongly anchoring the mats to the subgrade.

b. *Design factors (estimated).*

(1) Zero-damage wave height depends on strength of anchoring system and is probably in the range of 1 to 2 ft.

(2) Wave runup potential is 100 percent of smooth slope runup.

(3) Wave reflection potential is high.

c. *Prototype installations.* Unknown. A possible section is shown in Figure B-48.

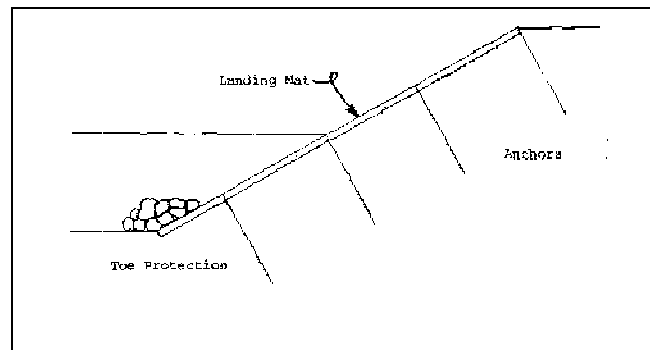

Figure B-48. Landing mat revetment

## B-27. Windrows

a. *General.* Windrows provide an alternative method of utilizing rock for slope protection. Instead of incurring the expense of constructing a formal revetment structure, the rock can be stockpiled at the top of a slope to be released when erosion causes the bank to retreat. As an alternative, the rock can be placed in a trench at the top of the bank and covered with soil and seed. In either case, the cost is probably less than with a formal revetment. The obvious disadvantage is that the random launching of this material down the slope probably does not allow for formation of an adequate filter layer beneath the larger armor stones. Presumably, if a large quantity

of well-graded stone were stockpiled in the windrow, natural sorting processes would eventually lead to development of an adequate filter given sufficient time and material. This method could be used at a site where some bank recession is acceptable before the windrow revetment is needed.

*b. Design factors.*

- (1) Zero-damage wave height is a function of stone size and gradation.
- (2) Wave runup potential is estimated to be as low as 50 percent of smooth slope runup.
- (3) Wave reflection potential is low.

*c. Prototype installations.* Actual sites are unknown, but the method has apparently received widespread use for riverbank protection in some areas of the country. A possible section is shown in Figure B-49.

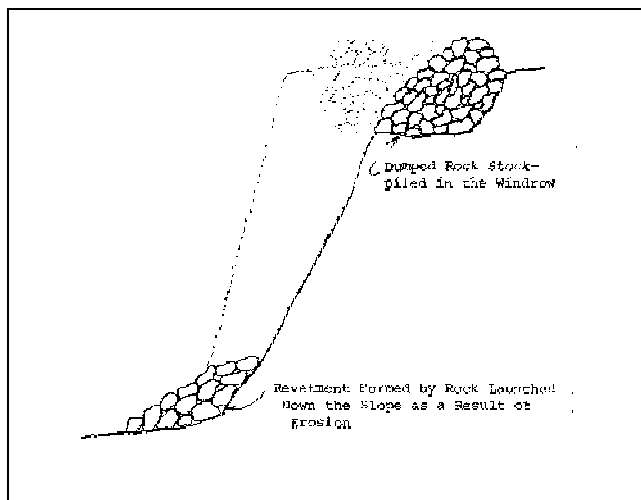

Figure B-49. Windrow revetment

## B-28. Vegetation

*a. General.* Vegetation can be a highly effective shore protection method when used under the right

conditions. Marsh grasses can be used as a buffer zone to dissipate incoming wave energy, and other species can be used in the area above the intertidal zone to directly protect and stabilize the shoreline. The appropriate species to use varies throughout the country. Smooth cordgrass (*Spartina alterniflora*) is excellent for marsh plantings in many areas. This is not true of the Great Lakes, however, where neither this nor other marsh species have been particularly successful for stabilizing shorelines. The best species for planting above the intertidal zone vary throughout the country, and only those that are well adapted to local conditions should be used.

*b. Design factors.*

- (1) Zero-damage wave height is estimated to be less than 1 ft although some installations survive in higher energy if they can become established during lower energy regimes.
- (2) Wave runup potential is low for well-established plantings.
- (3) Wave reflection potential is low for well-established plantings.

*c. Prototype installations (Figure B-50).* Four species of marsh plants, narrow- and broad-leaved cattails (*Typha augustifolia* and *T. latifolia*), giant reed (*Phragmites australis*), smooth cordgrass (*Spartina alterniflora*), and black needle rush (*Juncus roemerianus*) were planted at a site on Currituck Sound, NC, in 1973 (final report on Shoreline Erosion Control Demonstration Program). Profiles taken through the site and through an unplanted control area revealed that the erosion rate decreased as the vegetation became established in the planted area. By 1979 the control area had continued to erode at about 8.8 ft per year, while the protected area was stable and even accreting slightly.

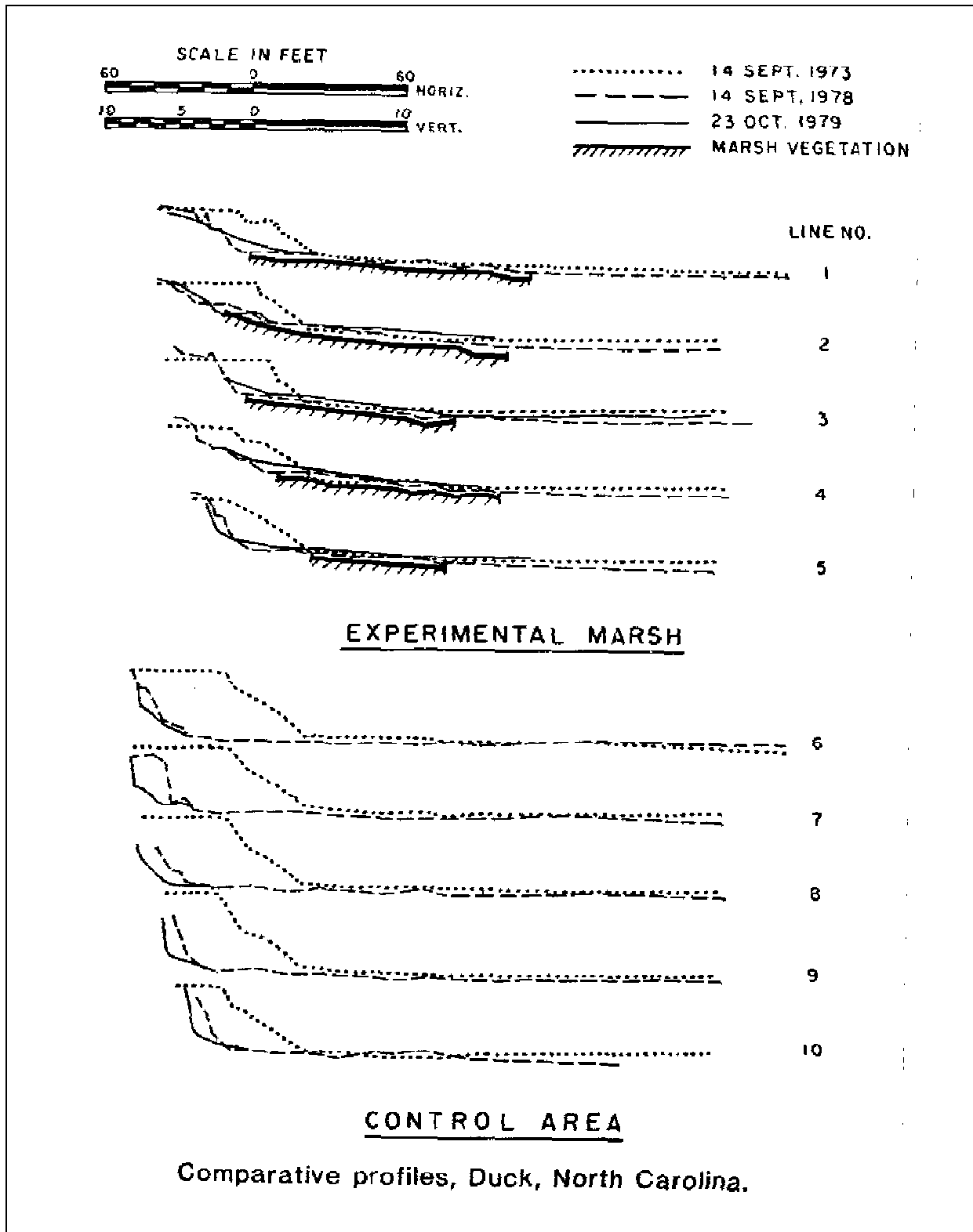

Figure B-50. Protective vegetative plantings

## Appendix C Seawalls

### C-1. Curved Face

*a. General.* A curved-face seawall is designed to accommodate the impact and runup of large waves while directing the flow away from the land being protected. As the flow strikes the wall, it is forced to flow along the curving face and ultimately is released in a vertical trajectory, falling harmlessly back to the ground, or it is recurved to splash back seaward, the tremendous wave forces that must be resisted and redirected require a massive structure with an adequate foundation. Wave reflections from the wall also demand sturdy toe protection.

*b. Prototype installation.* A classic example is the Galveston seawall (Figure C-1) built in response to the devastating hurricane that struck that area in 1900. A large concrete structure with a compound-radius face, it is founded on piles and fronted with heavy stone toe protection. The vertical height is about 16 ft, measured from the base of the concrete pile caps. In addition, a sheet-pile cutoff wall provides a last line of defense against toe scour that would threaten to undermine the wall.

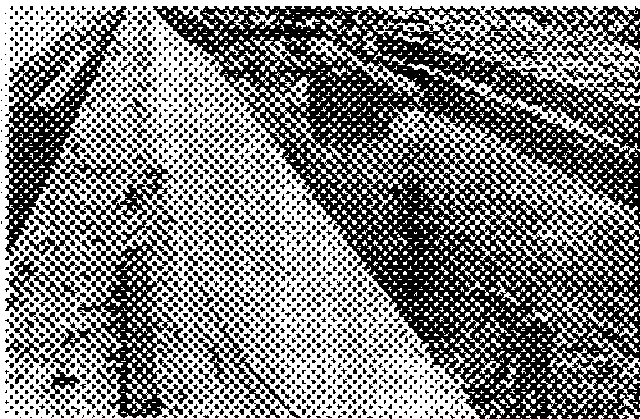

Figure C-1. Curved-face seawall, Galveston, TX

*c. Cross section of curved-face seawall.* A cross section of the Galveston seawall, fairly typical of this type of construction, is shown in Figure C-2.

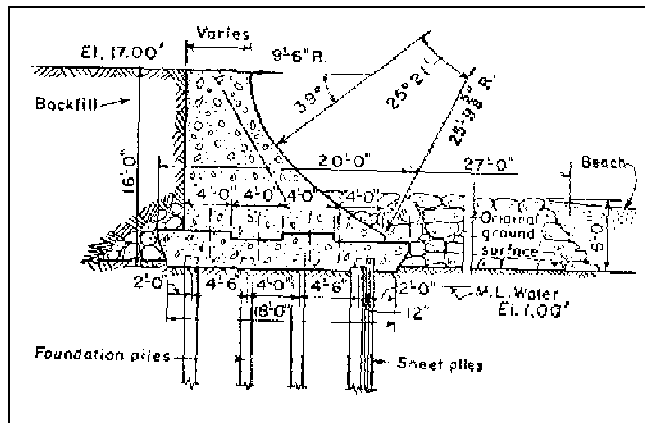

Figure C-2. Curved-face seawall cross section

### C-2. Stepped Face

*a. General.* These seawalls are designed to limit wave runup and overtopping by the hindering action of the stepped face on the advancing wave front. Although somewhat less massive than curved-face seawalls, the general design requirements for structural stability are the same for this kind of structure.

*b. Prototype installation (Figure C-3).* The best example is probably the Harrison County, MS, seawall (Escoffier and Dolive 1954). The total wall height is 8 ft, consisting of eight 12-in.-high steps. The horizontal width of the structure is 13.5 ft with nine 18-in.-wide treads. The structure is founded on wood piles, and sheetpiling is used as a cutoff wall to prevent undermining. No stone toe protection is employed.

*c. Cross section of prototype stepped-face wall.* Figure C-4 shows the features of the Harrison County seawall, which is typical of this type of construction.

### C-3. Combination Stepped and Curved Face

*a. General.* This kind of structure combines a massive curved face with a fronting stepped section that incorporates the advantages of both of those kinds of seawalls.

*b. Prototype installation.* The best example is the seawall near Ocean Beach in San Francisco, CA (Figure C-5). It represents what is perhaps the most massive

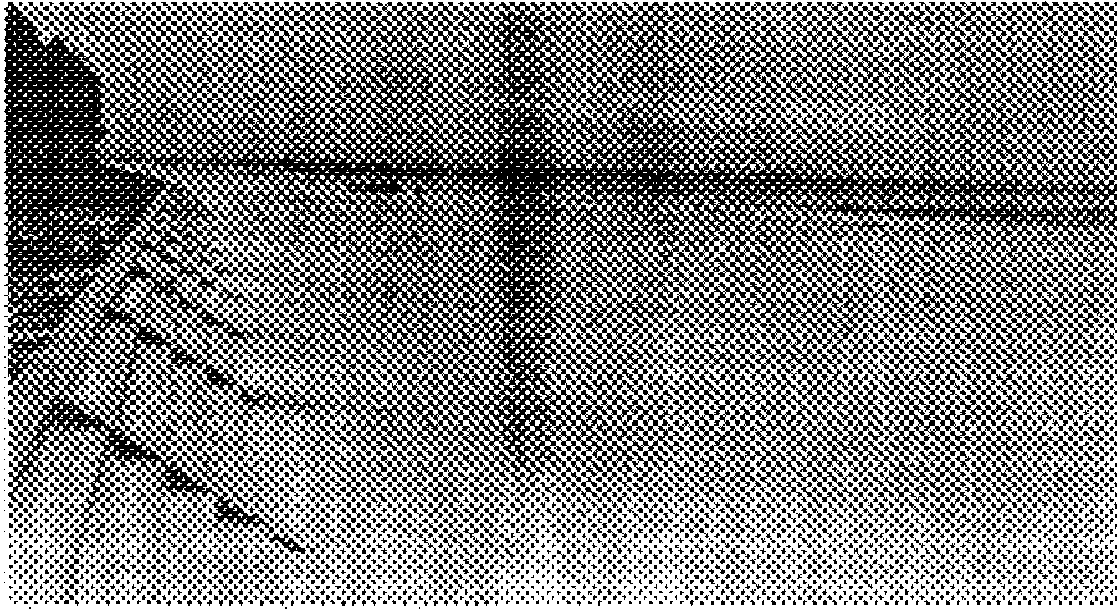

Figure C-3. Stepped-face seawall, Harrison County, MS

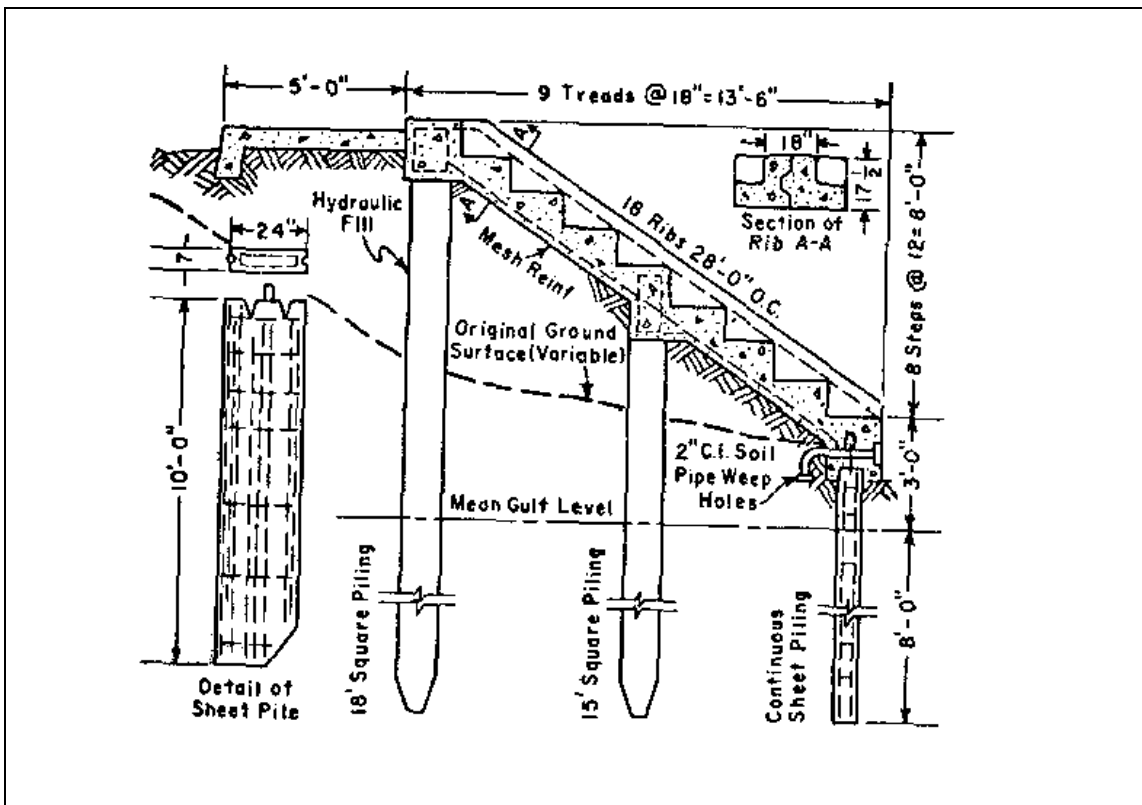
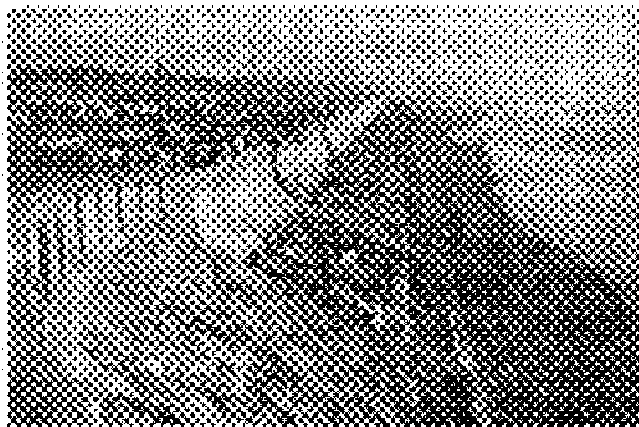

Figure C-4. Stepped-face seawall cross section



**Figure C-5. Combination stepped- and curved-face seawall, San Francisco, CA**

coastal structure ever built in this country. The initial stepped section rises about 10 ft to its junction with a short-radius curved face that continues vertically for an additional 10.5 ft. The wall is founded on piles, and interlocking sheetpiling provides an effective cutoff wall at the toe. In addition, the lower section of the stepped face is deeply buried below the original beach face to minimize the risk that toe scour would ever approach the cutoff wall.

*c. Cross section of combination wall.*

Figure C-6 shows the features of the San Francisco seawall, which is typical of this type of construction.

**C-4. Rubble**

*a. General.* A rubble seawall is essentially a rubble breakwater that is placed directly on the beach. The rock is sized in accordance with standard selection methods for

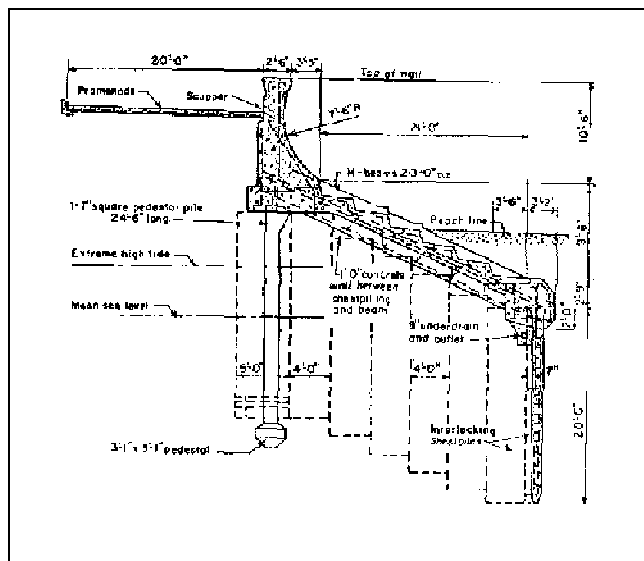

**Figure C-6. Combination stepped- and curved-face seawall cross section**

stability, and the structure acts to absorb and limit wave advance up the beach. The rough surface of such structures tends to absorb and dissipate wave energy with a minimum of wave reflection and scour.

*b. Prototype installation.* A typical structure at Fernandina Beach, FL, is shown in Figure C-7. The structure has a core of graded, small stones and an armor layer of large cap stones. In lieu of the rubble back slope, a concrete parapet wall could be substituted to provide a more positive barrier to the flow of water up the beach.

*c. Cross section of a rubble-mound seawall.* Figure C-8 shows the features of the Fernandina Beach seawall, which is typical of this type of construction.

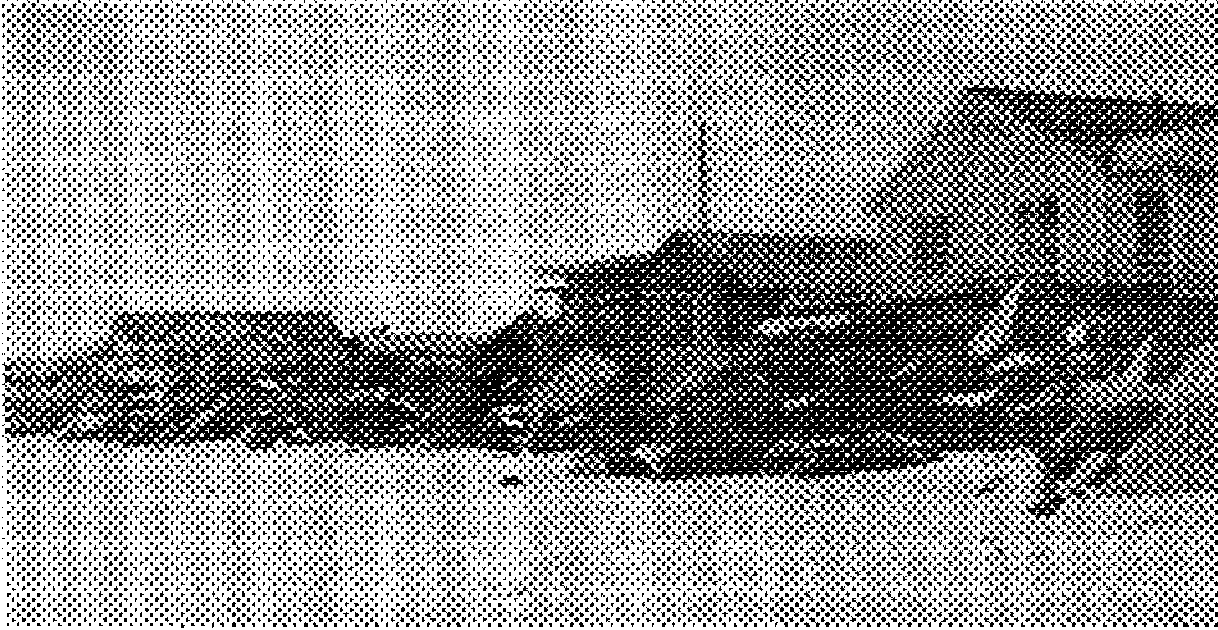

Figure C-7. Rubble-mound seawall, Fernandina Beach, FL

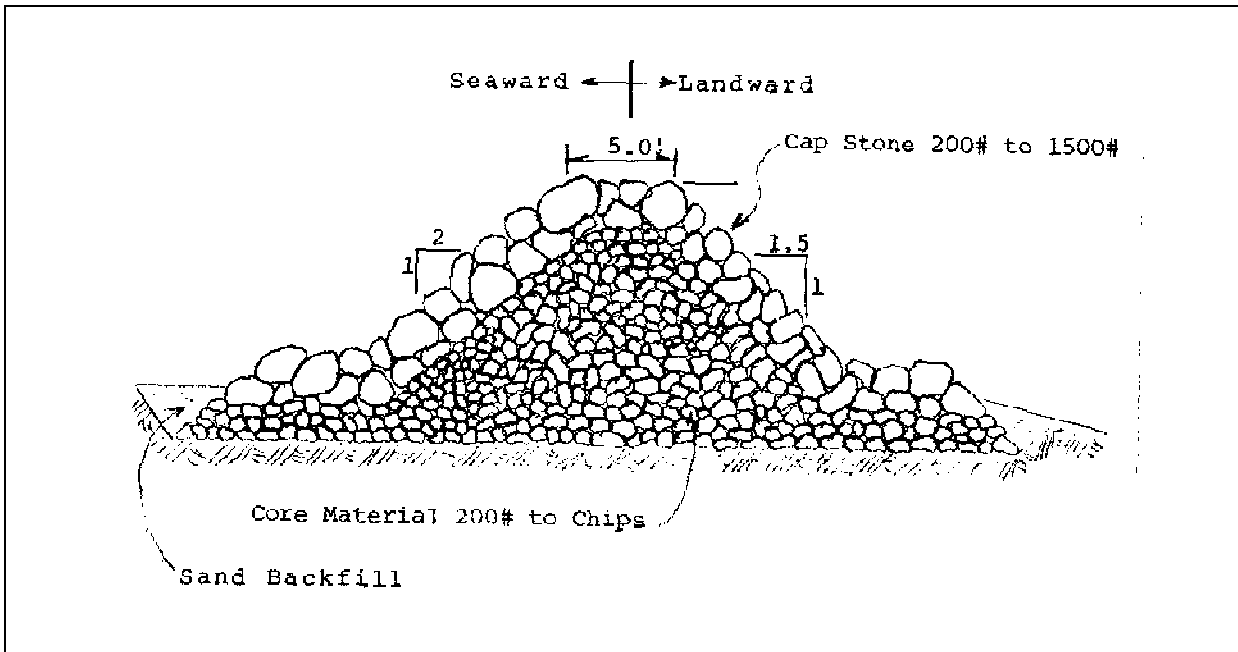

Figure C-8. Rubble-mound seawall cross section



## Appendix D Bulkheads

### D-1. Sheetpiling

Sheetpiling, available in various materials including steel, aluminum, concrete, and timber, is used in bulkheads that may be either cantilevered or anchored. Detailed design procedures are available in EM 1110-2-2906 or in standard references such as United States Steel Corporation (1975). Cantilevered bulkheads derive their support solely from ground penetration; therefore, the effective embedment length must be sufficient to prevent overturning. Toe scour results in a loss of embedment length and could threaten the stability of such structures. Anchored bulkheads gain additional support from anchors embedded on the landward side or from structural piles placed at a batter on the seaward side. Connections between the anchors and the bulkhead should be suitably corrosion protected. Horizontal wales, located within the top one third of the bulkhead height, distribute the lateral loads on the structure to the anchors.

### D-2. Steel Sheetpiling

*a. General.* Steel sheetpiling is the most widely used bulkhead material. It can be driven into hard, dense soils and even soft rock. The interlocking feature of the sheet-pile sections provides a relatively sand- or soil-tight fit that generally precludes the need for filters. This close fit may also be essentially water-tight, so regularly spaced weep holes are recommended. These and lifting holes in the piling should be backed with a proper filter to preclude loss of backfill material.

*b. Prototype installations* (Figures D-1 and D-2). Prototype performance is well documented and known through the experience gained at hundreds of sites throughout the United States.

### D-3. Timber Sheetpiling

*a. General.* Well-designed and well-built timber structures have long been recognized as viable and economical for marine use. At marine locations, only treated timber with corrosion-resistant or protected metals for hardware and fasteners should be used. Wrought iron anchor rods with turnbuckles and bolts have good durability, as do galvanized fasteners. Washers should be placed under bolt heads and nuts to ensure even bearing, but the number of these should be minimized to reduce the

exposed length of bolt shanks. Bolt holes should be no larger than required to provide a tight fit through the timbers. Joints between the timber sheeting should be minimized, and the use of a filter is recommended as an added precaution.

*b. Prototype installations.* Timber sheet-pile bulkheads have been installed at numerous locations throughout the United States. Their performance is well known and documented. A typical installation is shown in Figure D-3 and details of the construction are in Figure D-4.

### D-4. Aluminum Sheetpiling

*a. General.* Aluminum sheetpiling has been sold since 1969 and has been used successfully in many applications since then. Advantages of aluminum are light weight (2 to 4 lb/ft<sup>2</sup>), installation ease, good strength-to-weight ratios, and excellent corrosion resistance. The main disadvantage of aluminum compared to steel is that it cannot be driven through logs, rocks, or other hard obstructions. Special design and construction suggestions are available from suppliers (Ravens Metal Products 1981; Kaiser Aluminum and Chemical Sales 1979).

*b. Corrosion characteristics.* Aluminum has excellent corrosion resistance in a wide range of water and soil conditions because of the tough oxide film that forms its surface. Although aluminum is an active metal in the galvanic series, this film affords excellent protection except in several special cases. The first of these is the alloy composition of the aluminum itself. Alloys containing copper or silicon alone are susceptible to corrosion and should not be used. Second, differing mechanical or thermal treatment across the surface of the metal can set up electrical potential differences that could lead to corrosion. Therefore, welding should be done with care; and lifting holes, if needed, should be drilled rather than burned. Third, the oxide film is generally stable in the pH range of 4.5 to 8.5, but the nature of the dissolved compounds causing the pH reading is crucial. For instance, acidic waters containing chlorides are more corrosive to aluminum than those containing sulfates. Fourth, galvanic corrosion with dissimilar metals can be troublesome, particularly when contact is made with copper or carbon steel. Finally, certain soils tend to be corrosive to aluminum, particularly nondraining clay-organic mucks. As a general rule, contact with clay soils should be minimized unless special corrosion treatment measures are instituted. Where questions exist, expert advice should be sought from CERL.

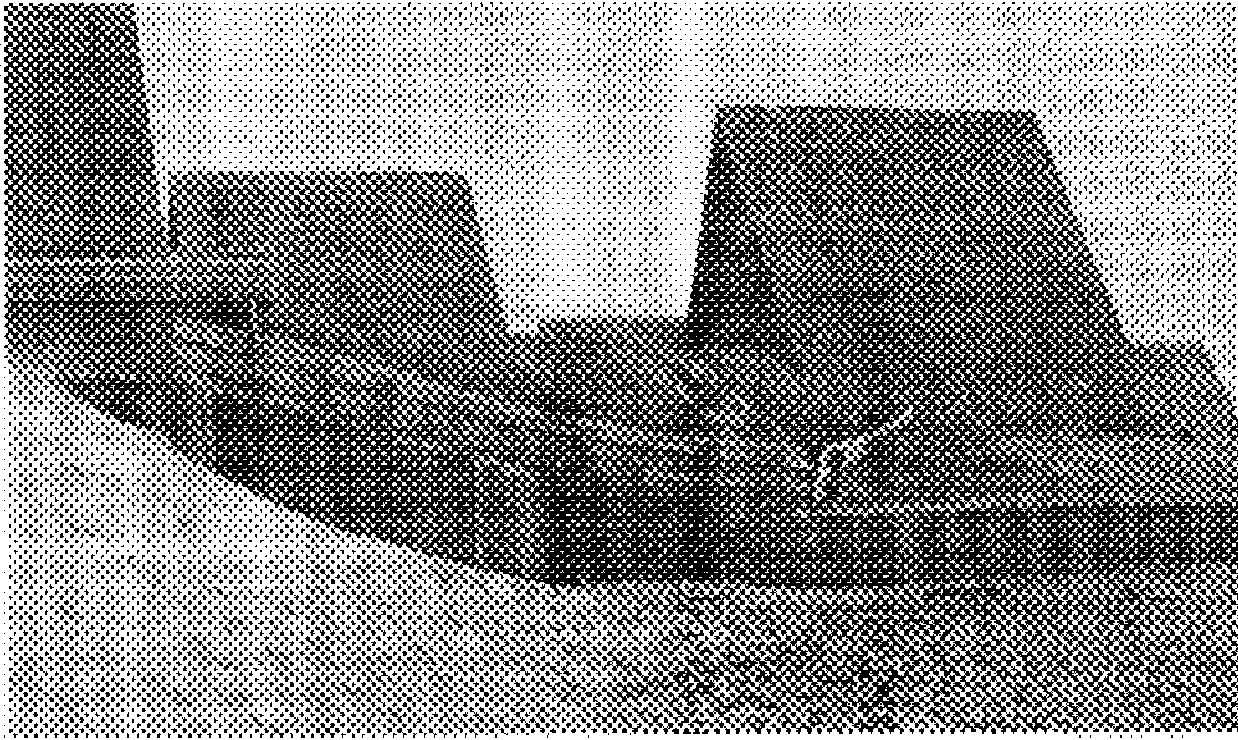

Figure D-1. Sheet-pile bulkhead, Lincoln Township, MI

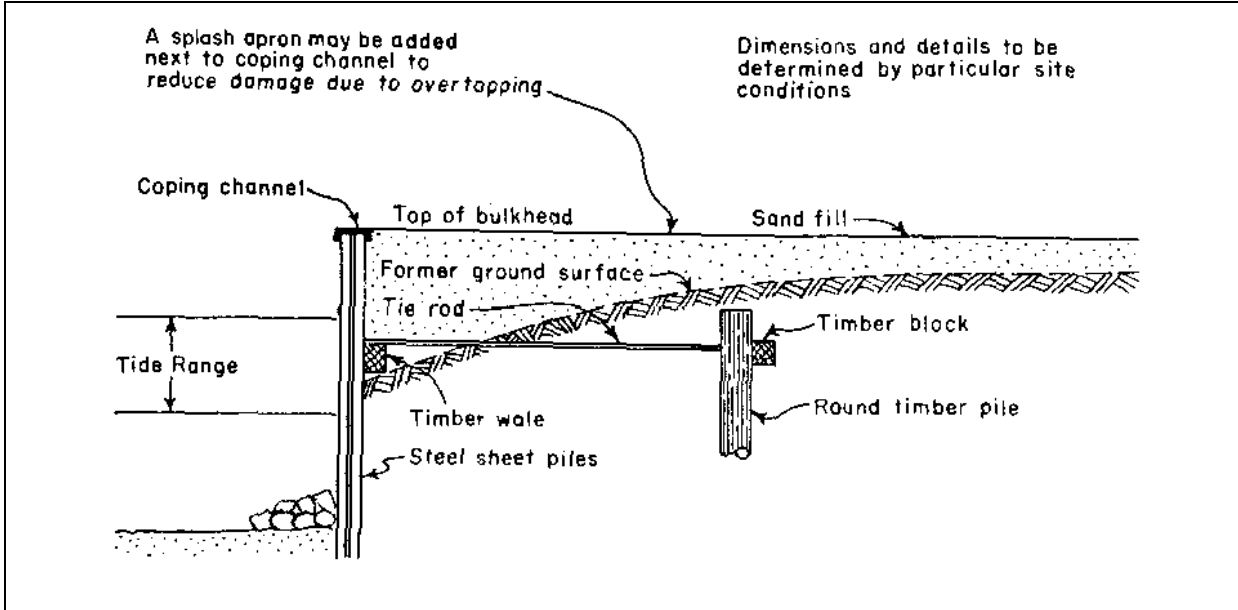

Figure D-2. Steel sheet-pile bulkhead cross section

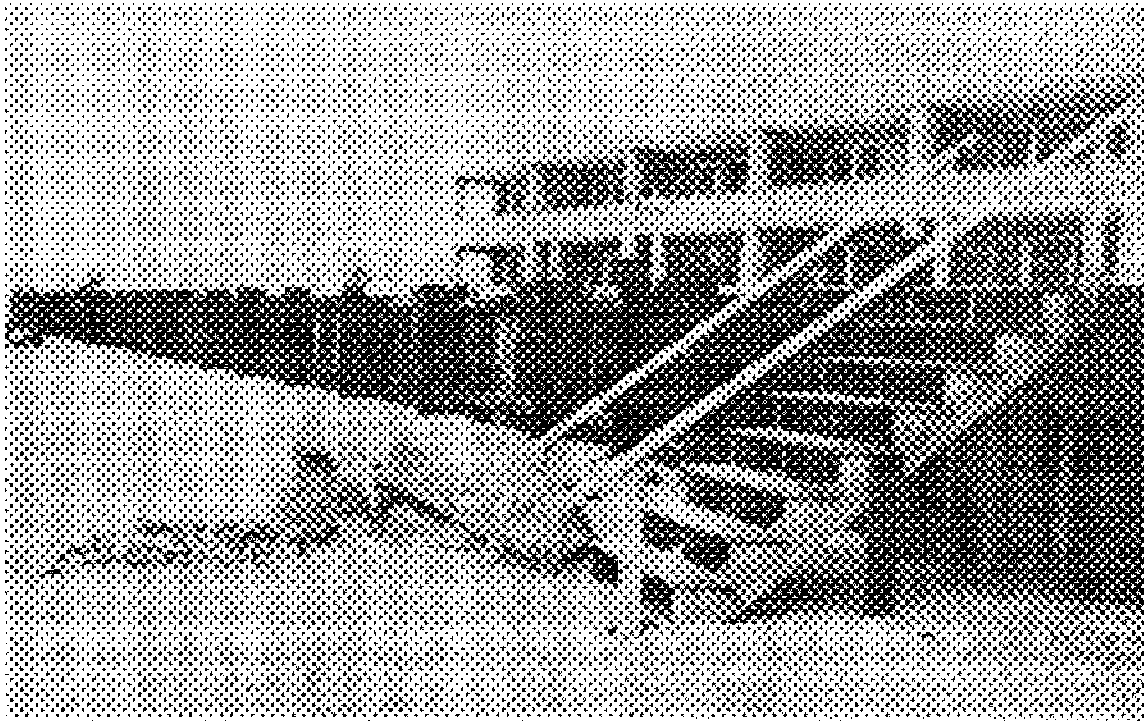

Figure D-3. Timber sheet-pile bulkhead, possibly at Fort Story, VA

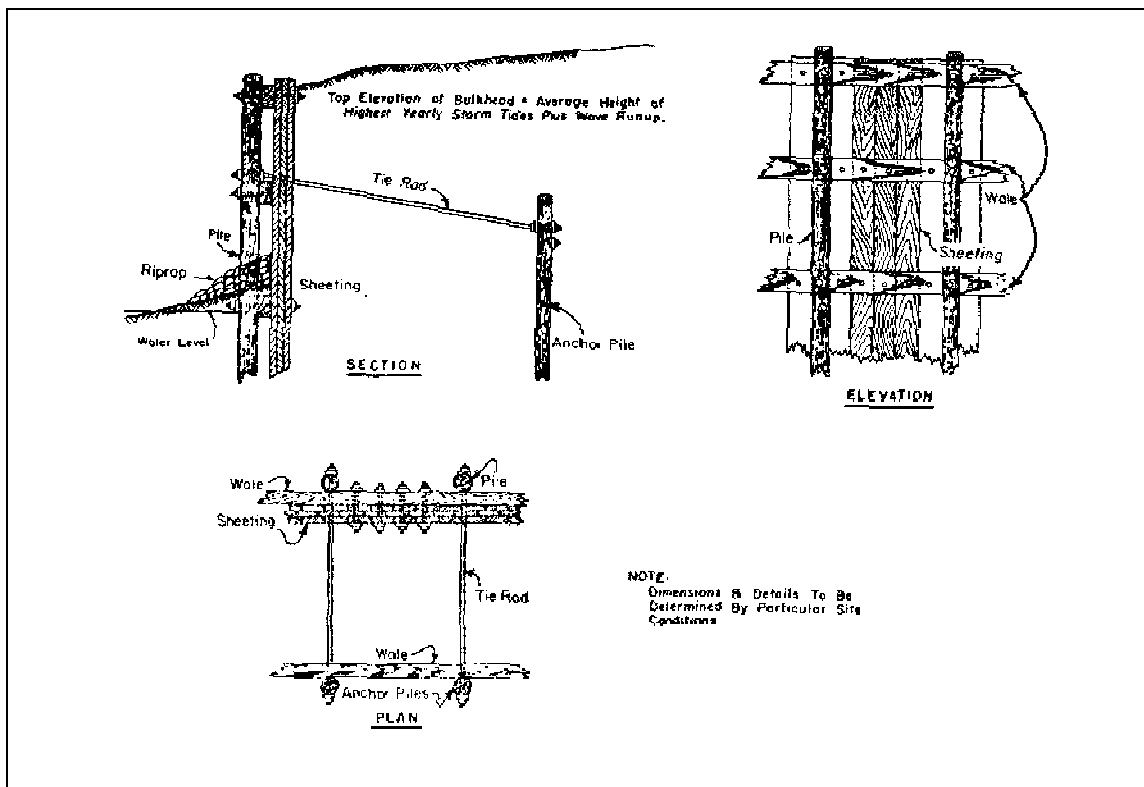

Figure D-4. Construction details of timber sheet-pile bulkhead

c. *Prototype installations (Figure D-5).* Aluminum sheetpiling has been installed at numerous locations around the country, including Bowens Inn, Calvert County, MD; Ocean Pines, Ocean City, MD; Hilton Head Island, SC; and West Bay, Galveston Island, TX. Specific performance data on these installations are unavailable.

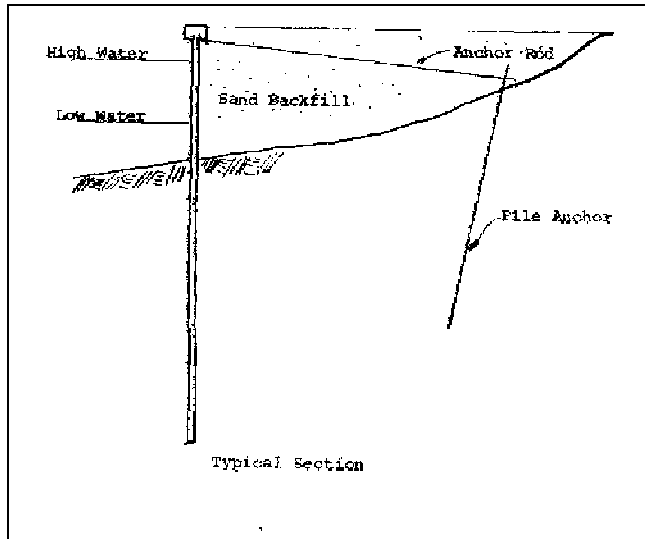

Figure D-5. Aluminum sheet-pile bulkhead cross section

## D-5. Concrete Sheetpiling

a. *General.* Prestressed concrete sheetpiling has been used throughout the United States. It is particularly advantageous where abrasion, corrosion, or marine-borer activity limits the use of other types of sheetpiling. While concrete sheetpiling is not generally available from most suppliers, it can be cast at the jobsite for large projects. Typical sections have a tongue-and-groove shape with thicknesses of 12 in. and widths of 3 ft. The actual dimensions for a given project will be a function of design loads.

b. *Prototype installations.* Figure D-6 shows a concrete sheet-pile bulkhead that was constructed at Folly Beach, SC. The design cross section is probably very similar to that shown in Figure D-1, with the exception that concrete was used. No specific design details were available for this structure.

## D-6. Cellular Steel Sheetpiling

a. *General.* Cellular steel sheetpiling can be used in areas where adequate pile penetration cannot be obtained.

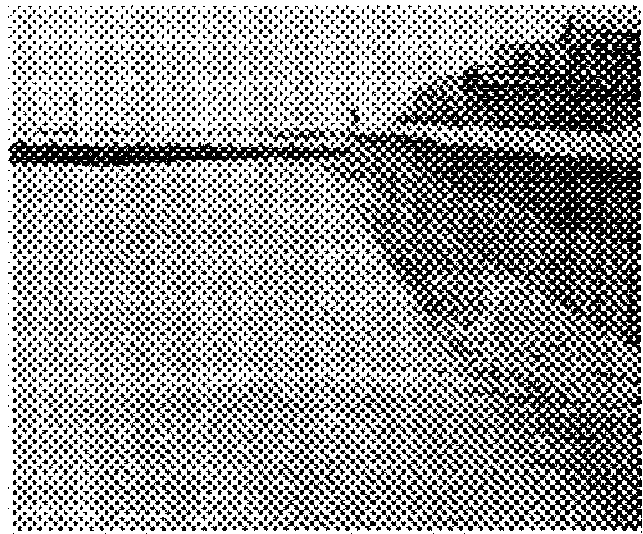

Figure D-6. Concrete sheet-pile bulkhead, Folly Beach, SC

A typical wall consists of cells, each constructed with semicircular walls connected by cross diaphragms. Each cell is then filled with sand, gravel, stone, or other material to provide structural stability. Unlike other sheet-pile structures, this is a gravity device that resists sliding by bottom friction and overturning by the moment supplied by its weight. Toe protection is crucial to prevent loss of fill through the bottom of the cell, and a concrete cap is necessary in most cases to protect against loss of fill due to overtopping waves. This is a higher cost and more massive equivalent of the used concrete pipe bulkhead described in paragraph D-17.

b. *Prototype installation (Figure D-7).* This type of construction has been used on the Great Lakes, primarily for groins. No specific bulkhead installations are known for which background information is available. A possible plan and cross section are shown in Figure D-7.

## D-7. Post-Supported Bulkheads

Post-supported bulkheads consist of regularly spaced piles or posts with an attached facing material that retains the backfill. The posts, support components of the bulkhead, resist the earth and wave pressures that are generally distributed to them by the facing material. This type of bulkhead, like sheetpiling, can be either cantilevered or anchored.

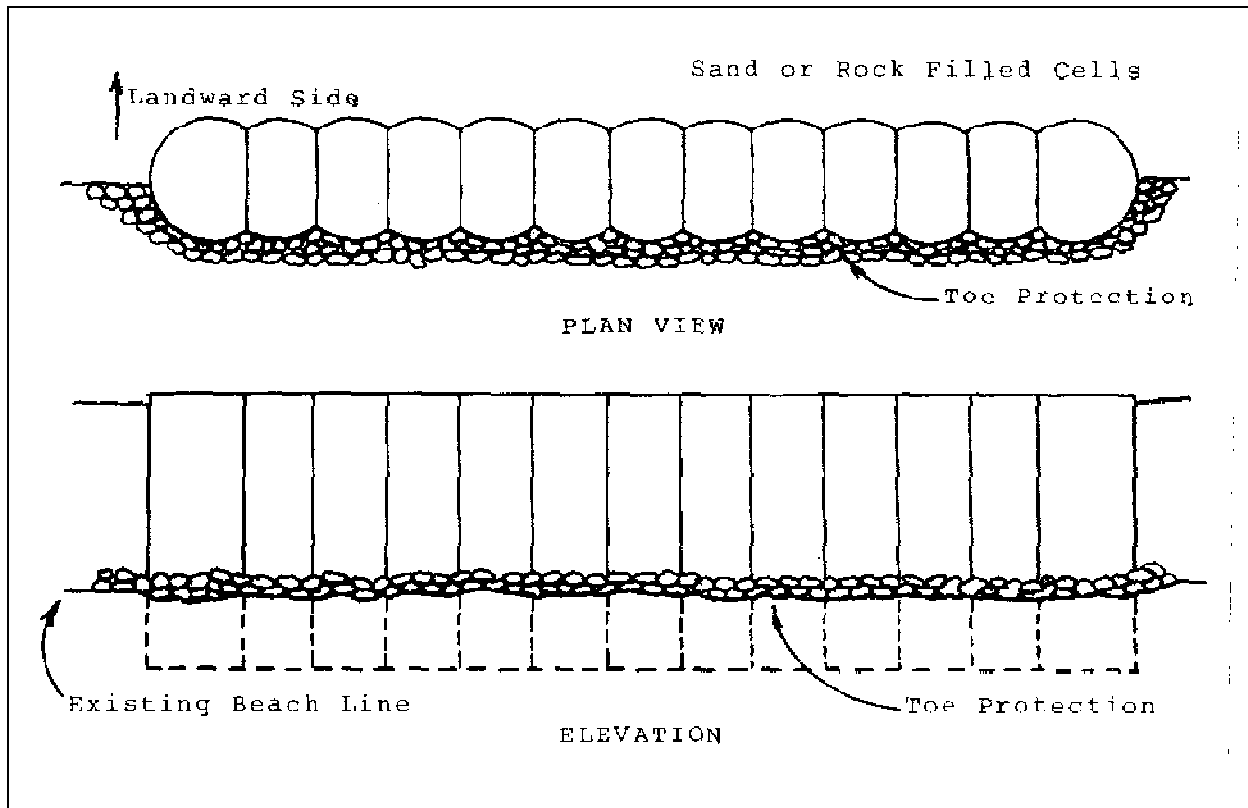

Figure D-7. Cellular steel sheet-pile bulkhead plan and cross section

### D-8. Concrete Slabs and King-Piles

*a. General.* Conceptually, the system utilizes vertical concrete king-piles that are H-shaped in section. Tongue-and-groove precast slabs are placed between the flanges of the king-piles to form a heavy, continuous retaining structure.

*b. Prototype installation.* This type of structure was built in 1953 at Virginia Beach, VA, and is shown in Figures D-8 and D-9. Features include a cast-in-place concrete cap, or headwall, which is used to support the seaward edge of a concrete walkway as shown in Figure D-9. Regularly spaced weep-holes are provided for hydrostatic pressure relief, and stairs, placed at intervals, provide access to the beach. The seaward toe of the stairs is pile supported, and the upper end is keyed into the concrete headwall.

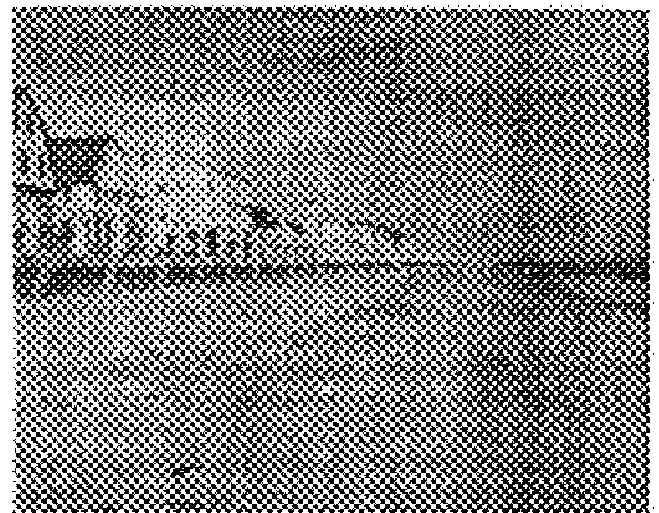

Figure D-8. Concrete slab and king-pile bulkhead

### D-9. Railroad Ties and Steel H-Piles

*a. General.* Although utilizing different construction materials, this system is almost identical in concept to the

previous one. The railroad ties, however, require a cap to retain them in place due to their natural buoyancy.

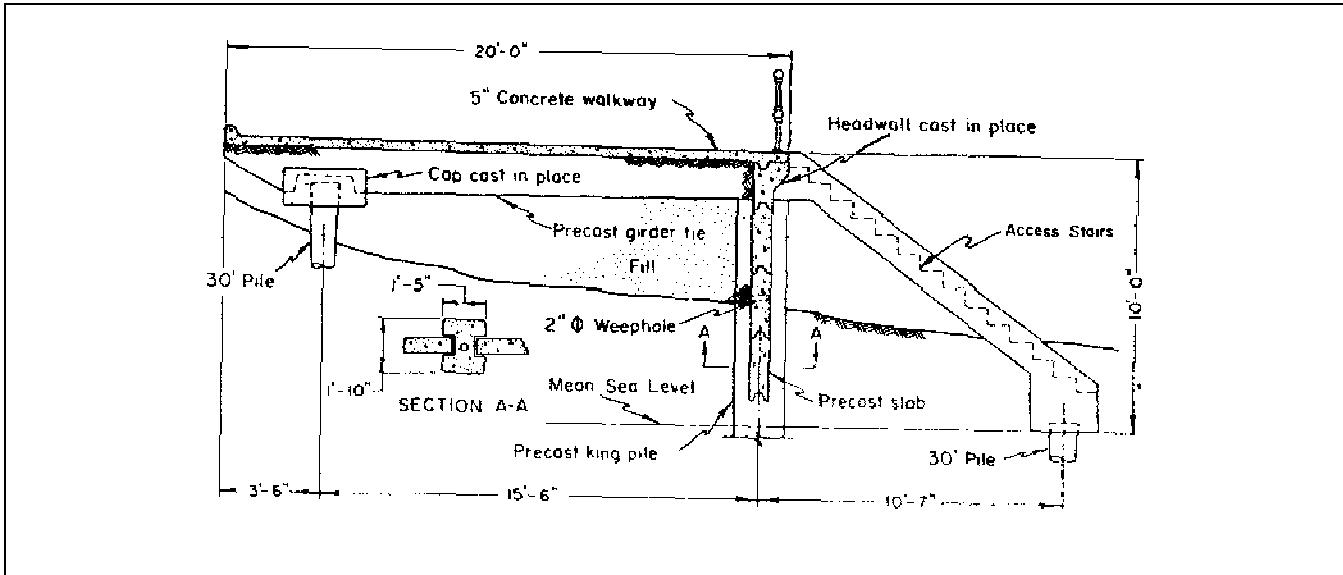

Figure D-9. Concrete slab and king-pile bulkhead cross section

*b. Prototype installation (Figures D-10 and D-11).* A bulkhead using this system was built at Port Wing, WI, in November 1978 (final report on the Shoreline Erosion Control Demonstration Program). The H-piles were set about 12 ft into the sandstone bedrock on 8-ft centers in holes drilled by a truck-mounted auger. After the piles were grouted in place, the railroad ties were placed between the flanges, and a steel channel was welded to the top. Rock toe protection was provided, and a non-woven filter cloth and granular backfill were used behind the wall. The structure subsequently weathered several severe storms with little or no structural damage.

#### D-10. Treated Timber

*a. General.* Horizontal, pressure-treated planks can be spiked to the landward side of the posts that are anchored to deadmen or piles in the backfill. The planks must be backed by filter cloth or graded stone to prevent soil losses through the cracks. Riprap toe protection should be provided.

*b. Prototype installation (Figures D-12 and D-13).* Devices of this kind are fairly common where timber is economical (final report on the Shoreline Erosion Control Demonstration Program). An excellent prototype example is a structure that was built at Oak Harbor, WA, in June 1978. Constructed at the base of a 30-ft-high bluff, it utilized treated 8-in.-square posts on 4-ft centers to which 3- by 12-in. planks were spiked. Anchors were connected to each post, the landward face was covered with a non-woven filter cloth, and rock toe protection was placed in

front of the wall. The structure has withstood several storms with some damages due to loss of backfill through discontinuities in the filter cloth. Repairs of these faults improved subsequent performance and limited later damages.

#### D-11. Untreated Logs

*a. General.* Similar to the previous system, this method employs untreated logs as the basic construction material in lieu of treated timbers.

*b. Prototype installation (Figures D-14 and D-15).* A typical prototype structure was built at Oak Harbor, WA, in June 1978 (final report on Shoreline Erosion Control Demonstration Program). It consisted of large log posts spaced on 4-ft centers to which horizontal logs were spiked. These were backed by a gravel filter and granular backfill that provided the basic support to the structure under wave conditions. A February 1979 storm later washed out the gravel filter and backfill. Deprived of support from behind, the structure was essentially destroyed as the horizontal logs were displaced. A strong filter cloth capable of bridging the gaps between the logs may have yielded adequate performance and prevented failure by retaining the backfill.

#### D-12. Hogwire Fencing and Sandbags

*a. General.* Hogwire fencing attached to posts can be used to support sandbags stacked on the landward side



Figure D-10. Railroad ties and steel H-pile bulkhead, Port Wing, WI

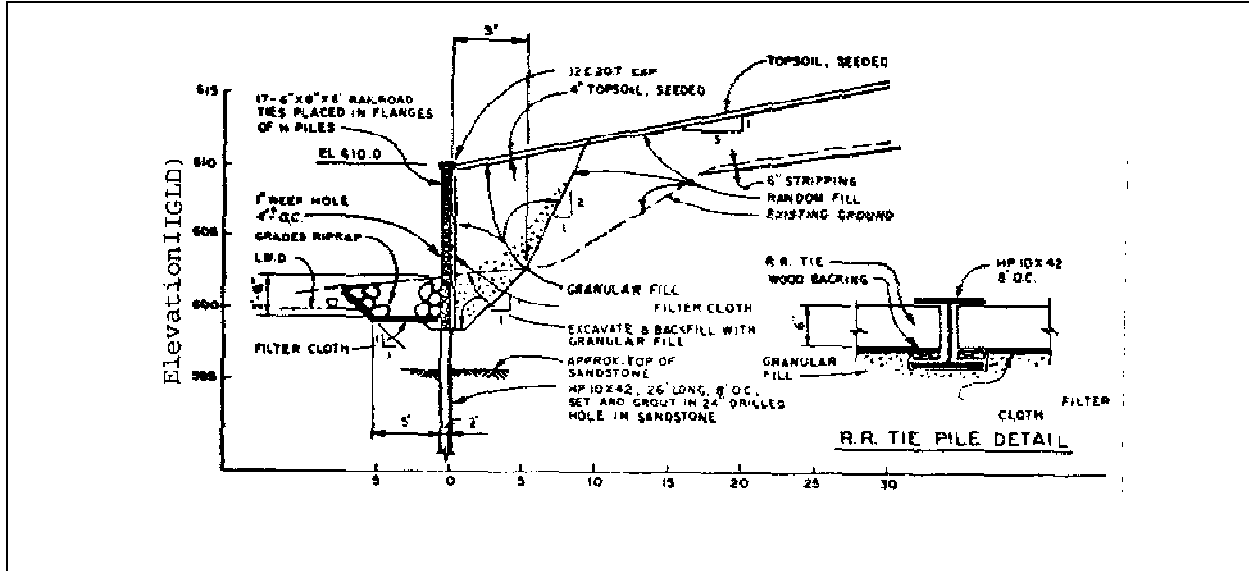

Figure D-11. Railroad ties and steel H-pile bulkhead cross section

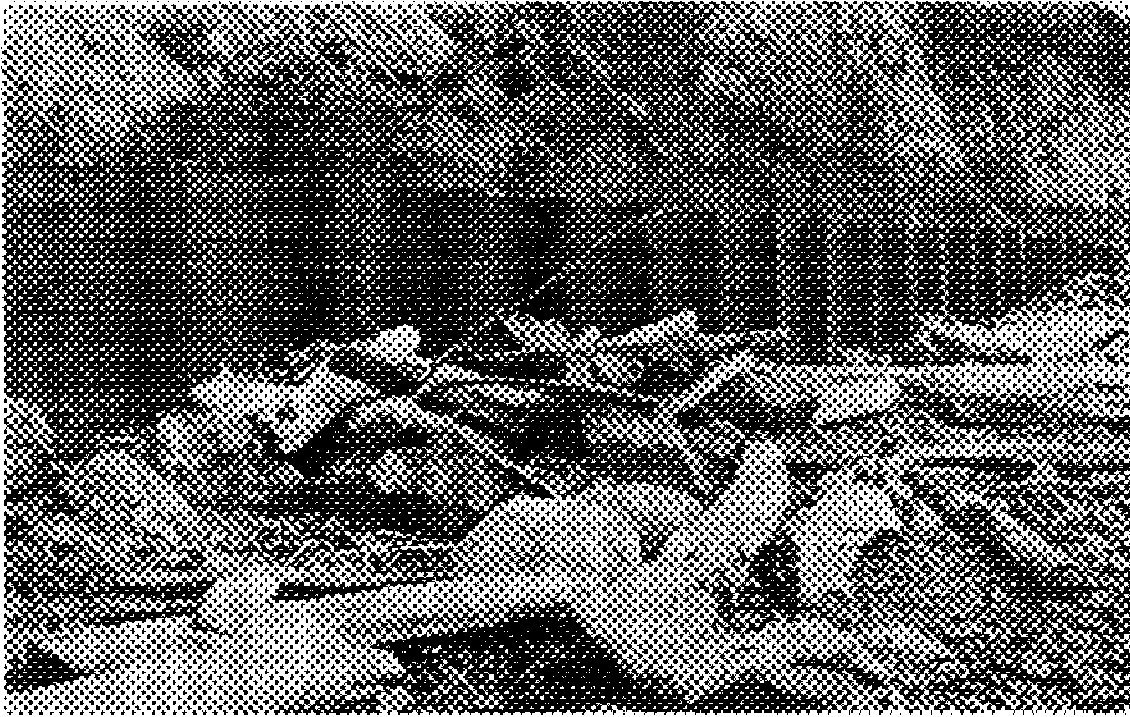

Figure D-12. Treated timber bulkhead, Oak Harbor, WA

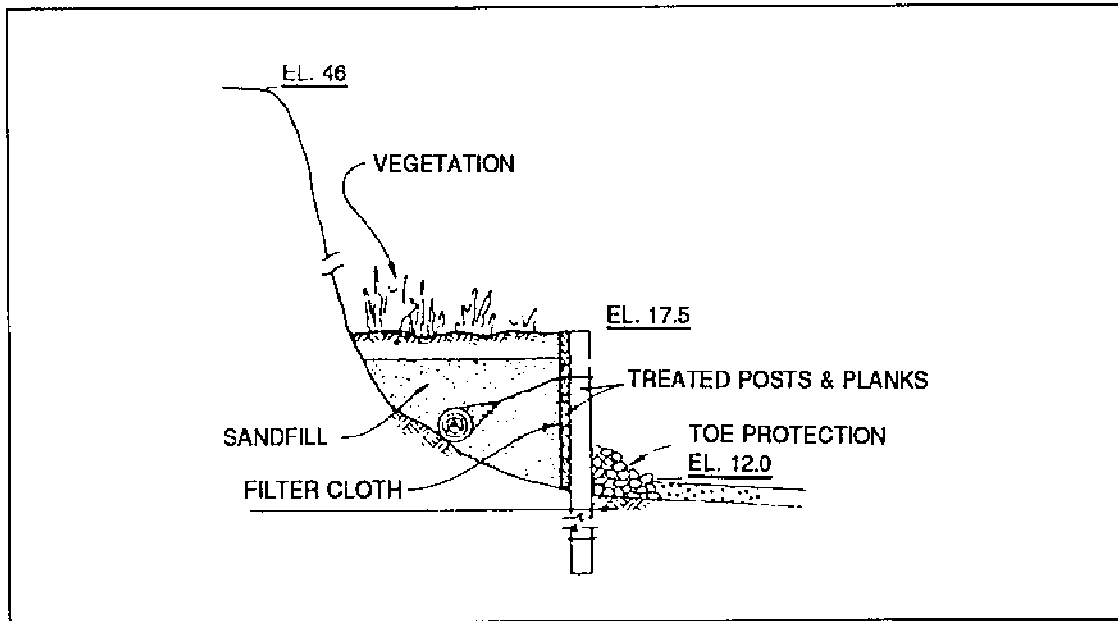

Figure D-13. Treated timber bulkhead cross section



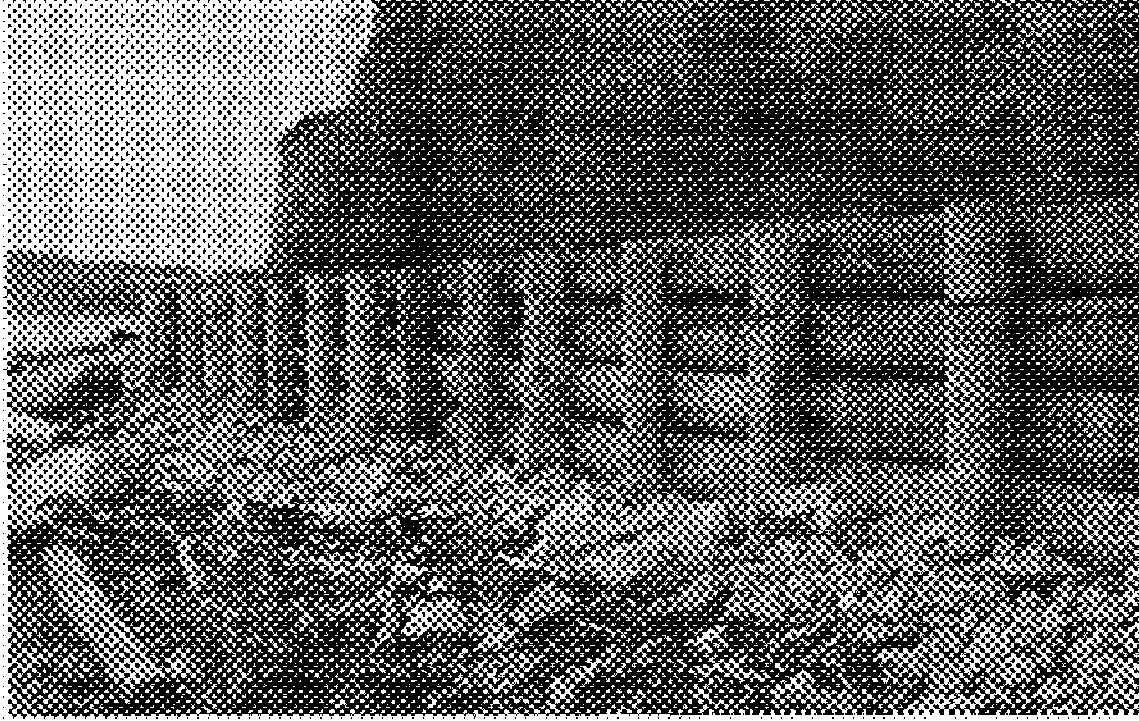

Figure D-14. Untreated log bulkhead, Oak Harbor, WA

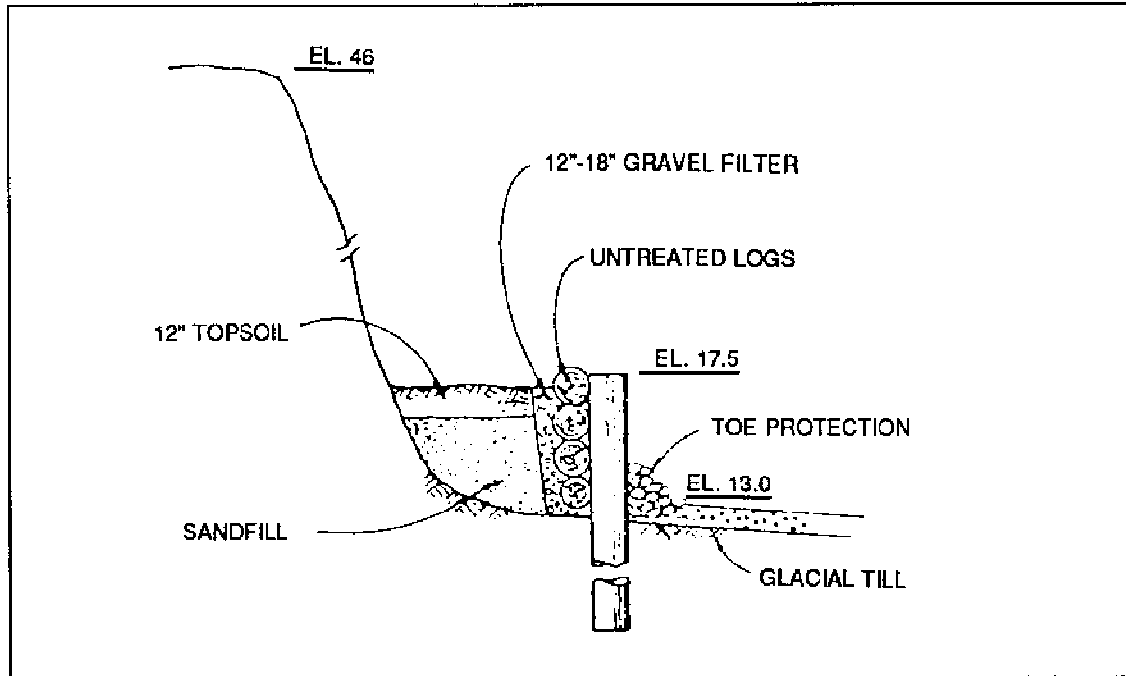

Figure D-15. Untreated log bulkhead cross section

of the fence to form a relatively inexpensive structure. The sandbags are vulnerable to tearing, however, if they are undercut by toe scour and slide against the hogwire fencing. Best performance is achievable using PVC-coated, small mesh wire to minimize corrosion and damage to the bags. Tearing of the exposed front row of bags can be minimized by filling them with a sand-cement mixture. This allows the use of burlap bags in place of more expensive synthetic fabric bags that must be stabilized against ultraviolet light. Finally, the bags and fencing should be placed in a trench excavated to the anticipated scour depth to minimize shifting and damage to the bags.

b. *Prototype installation (Figures D-16 and D-17).* A 200-ft section of fence and bag bulkhead was used to protect a low bluff at Basin Bayou State Recreation Area, FL (final report on Shoreline Erosion Control Demonstration Program). Constructed in early December 1978, it consisted of timber posts at 5-ft centers with 36-in. hogwire fencing stretched between. The basic sections were constructed--one two bags wide and the other three bags wide. One half of each of these sections was constructed using acrylic bags and the other half using polypropylene bags. The structure failed after a short period of time when the polypropylene bags, which were not stabilized against ultraviolet light, disintegrated rapidly. The acrylic bags did not disintegrate, but they were not sufficiently entrenched and so were displaced and torn as toe scour proceeded. Adherence to the guidelines specified above would probably yield more acceptable results for short-to-medium-term performance.

### D-13. Used Rubber Tires and Timber Posts

a. *General.* Closely spaced vertical posts can be strung with used rubber tires to form an inexpensive bulkhead. Tires are advantageous because they are tough and durable and are available free in most areas. The large gaps between the adjoining tires create a problem in providing an adequate filtering system.

b. *Prototype installation (Figures D-18 and D-19).* Used tire bulkheads have been constructed at many locations around the country (final report on Shoreline Erosion Control Demonstration Program). A good example is one that was built at Oak Harbor, WA, in the summer of 1978. Placed at the toe of a high bluff, it consisted of two rows of staggered posts with tires placed over them to form a structure approximately 4.5 ft high. The tires

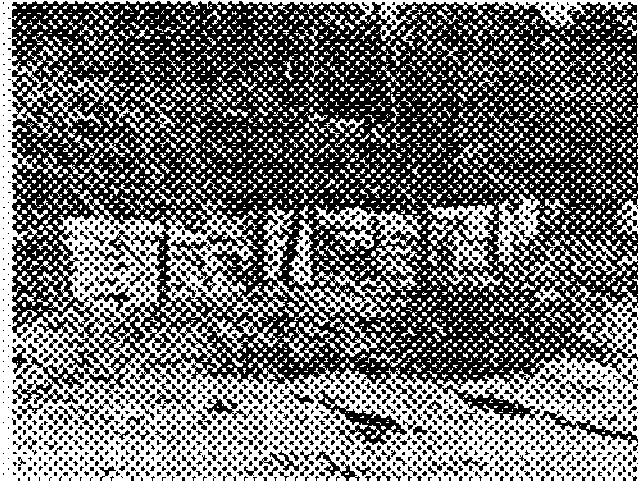

Figure D-16. Hogwire fence and sandbag bulkhead Basin Bayou Recreation Area, FL

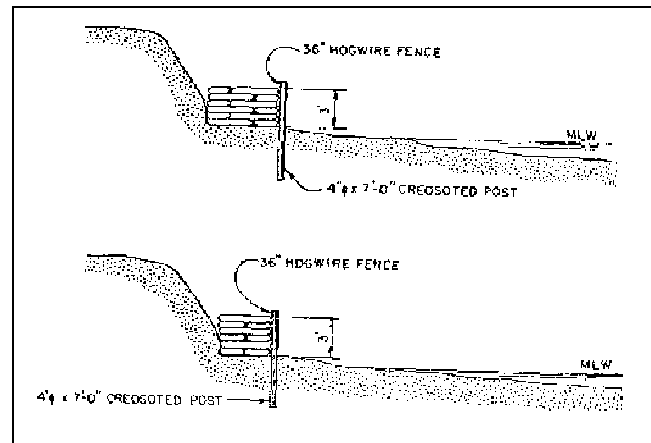

Figure D-17. Hogwire fence and sandbag bulkhead cross section

were filled with gravel as they were placed, and wire rope was used to fasten the posts to deadman anchors. Half of the structure had no filter, and the other half had equal segments of gravel and filter cloth protection. Storms that occurred after installation removed the backfill behind the unfiltered portion of the structure. The bulkhead experienced no structural damages, however, and the continued sloughing of the bluff eventually deposited enough material behind the bulkhead to allow natural sorting processes to form an effective filter cake. The filter-protected portions performed well throughout. Despite the ultimately successful performance of the unfiltered portion, a

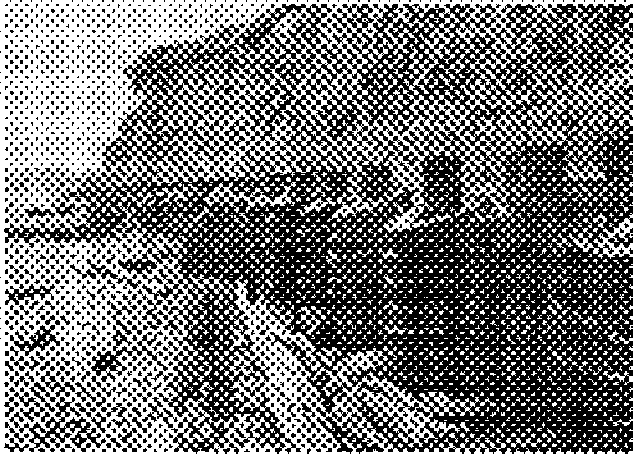

Figure D-18. Used rubber tire and timber post bulkhead, Oak Harbor, WA

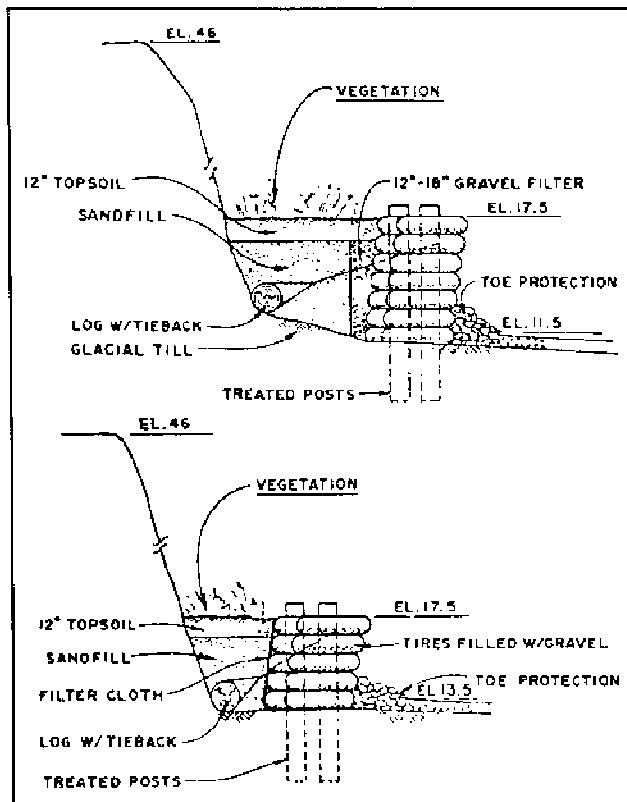

Figure D-19. Used rubber tire and timber post bulkhead cross section

structure such as this should always be constructed with a filter unless a large supply of well-graded backfill is available for a filter to form by sorting processes.

#### D-14. Miscellaneous

The following are basically gravity structures that depend on weight and sliding friction to retain the fill. They are generally easier to construct than post-supported bulkheads, yet they offer less stability in some cases because they do not penetrate subsurface failure surfaces that may be critical in some bluff situations.

#### D-15. Timber Cribbing

*a. General.* Timber crib bulkheads are constructed of heavy-duty timbers (6- by 6-in. minimum) that are stacked in alternating layers to form an open weave, box-like structure. This box is then filled with stone (at least 50 lb) to form a massive wave-resistant structure. Threaded rods with washers and nuts can be used at each corner to fasten the structure together. Adherence to filtering provisions and toe protection requirements is essential. If the gaps between the timbers are too large to retain the available stone, notching the ends will decrease the spacing between members.

*b. Prototype installation (Figure D-20).* Structures of this kind are located throughout the United States, particularly on the Great Lakes. In marine applications, care should be taken to use properly treated timber to resist marine borer activity.

#### D-16. Stacked Rubber Tires

*a. General.* Tires have often been tried for shore-protection devices because of their ready availability at most locations. These can be stacked in some pyramid fashion to form a bulkhead. Success depends in large measure on the strength of the interconnections between the tires, a common failure point for this kind of structure. While availability of tires is a strong temptation to use them for shore protection, they are extremely rugged and cannot be fastened securely together except by considerable effort and expense. In most cases, failures result from inadequate connections.

*b. Prototype installations (Figures D-21 and D-22).* A stacked tire bulkhead was constructed at Port Wing, WI, in July 1979 (final report on Shoreline Erosion Control Demonstration Program). The tires were placed flat, as shown, with the holes in successive layers of tires being staggered. A row of anchors on 10-ft centers was installed near the toe, middle, and top of the structure. The anchors were 0.75-in. galvanized rods with 4-in.

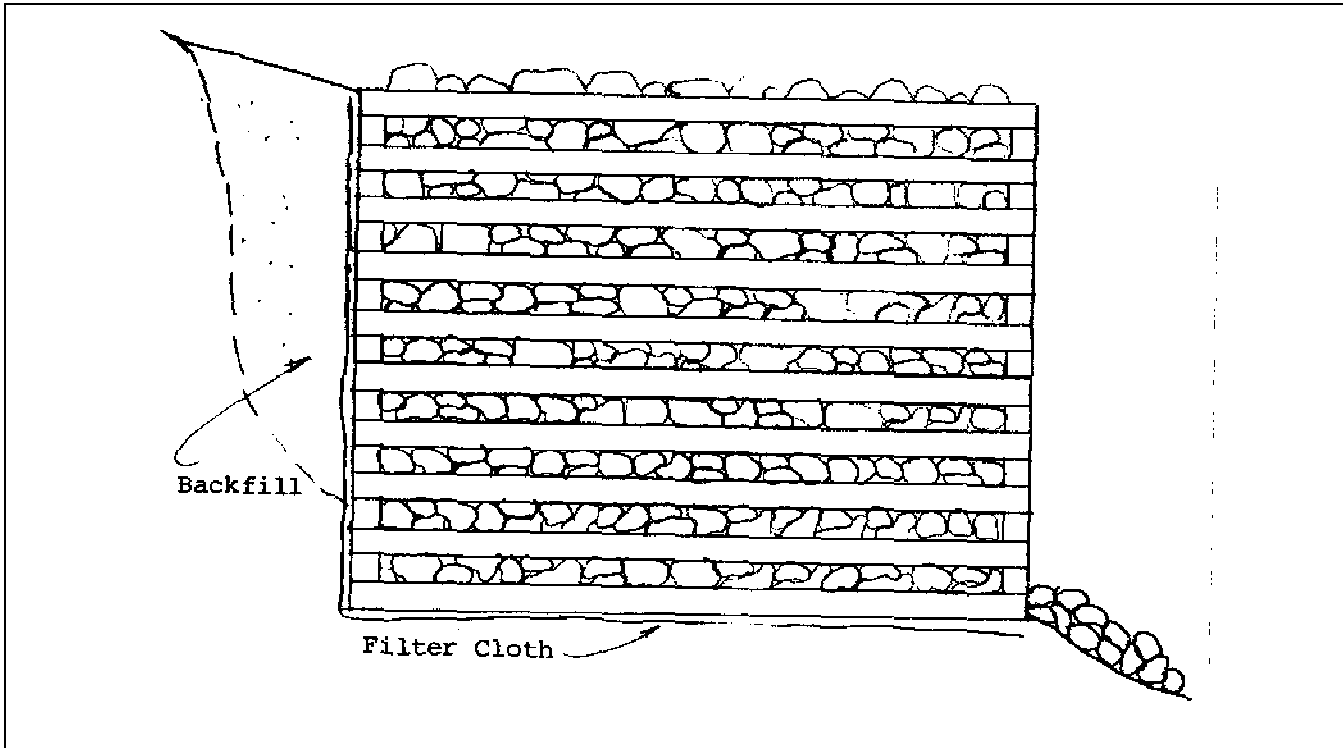

Figure D-20. Timber crib bulkhead cross section

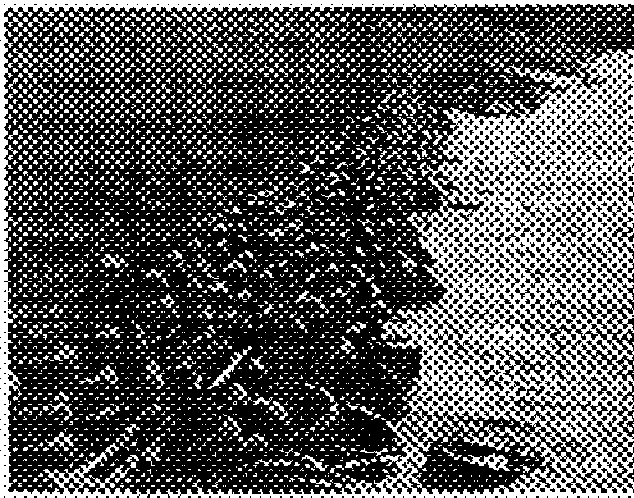

Figure D-21. Stacked rubber tire bulkhead, Port Wing, WI

anchors, similar to those used for power poles. Non-woven filter cloth was used behind the structure. Interconnections between tires were made with 40-d galvanized spikes with steel push nuts. These proved to be

weak, however, and many tires were lost during the first 12 months. Later accretion of the beach in front of the structure may have served to protect it since subsequent damages occurred at a slower rate. A stronger connector would be necessary to achieve long-term stability.

#### D-17. Used Concrete Pipes

*a. General.* Used concrete pipes can be placed on end, side by side, to form a continuous wall. To increase stability, the pipes are filled with gravel or other beach materials, and a concrete cap may be employed to ensure retention of the gravel. Filtering must be provided to prevent loss of soil between the cracks in the pipes. The protection is also a crucial consideration.

*b. Prototype installation (Figures D-23 and D-24).* A typical structure was built around 1976 along the northwest shore of Trinity Bay in McCollum County Park, Beach City, TX (final report on Shoreline Erosion Control Demonstration Program). The 800-ft-long bulkhead consists of a single row of vertical concrete pipes. The units were cracked, chipped, or otherwise unsuitable for culvert use. The pipe lengths were 4 ft, but the diameters varied from 36 to 90 in. Figure D-23 shows the remnants of a

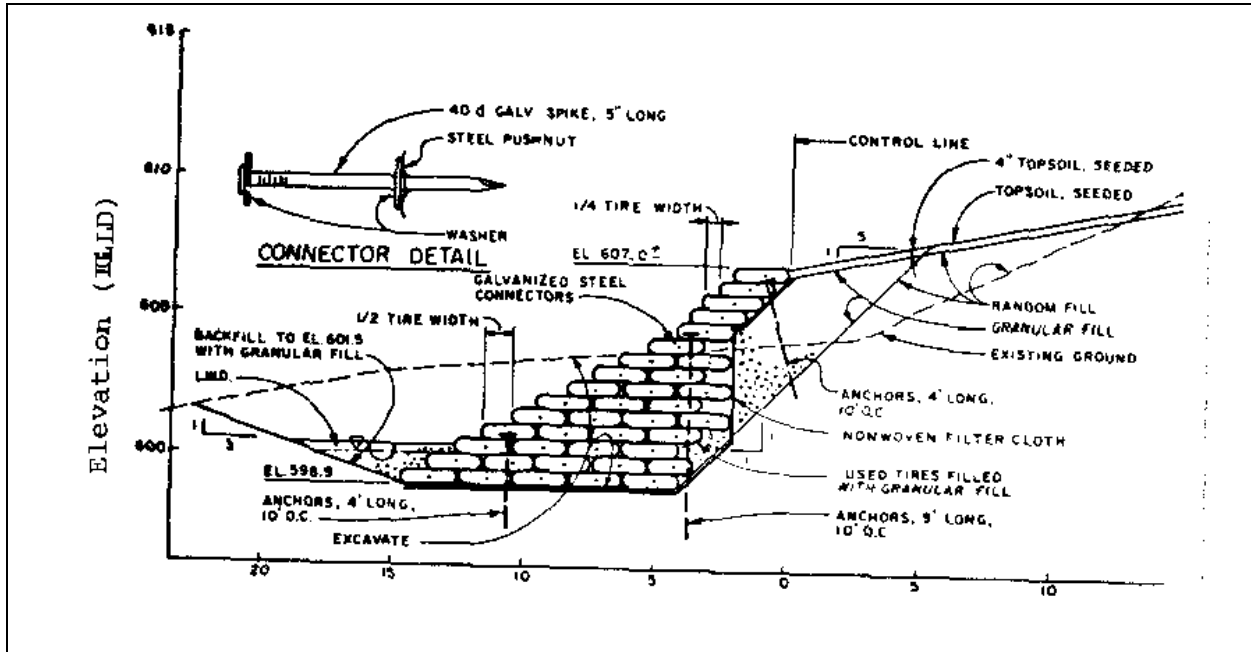

Figure D-22. Stacked rubber tire bulkhead cross section

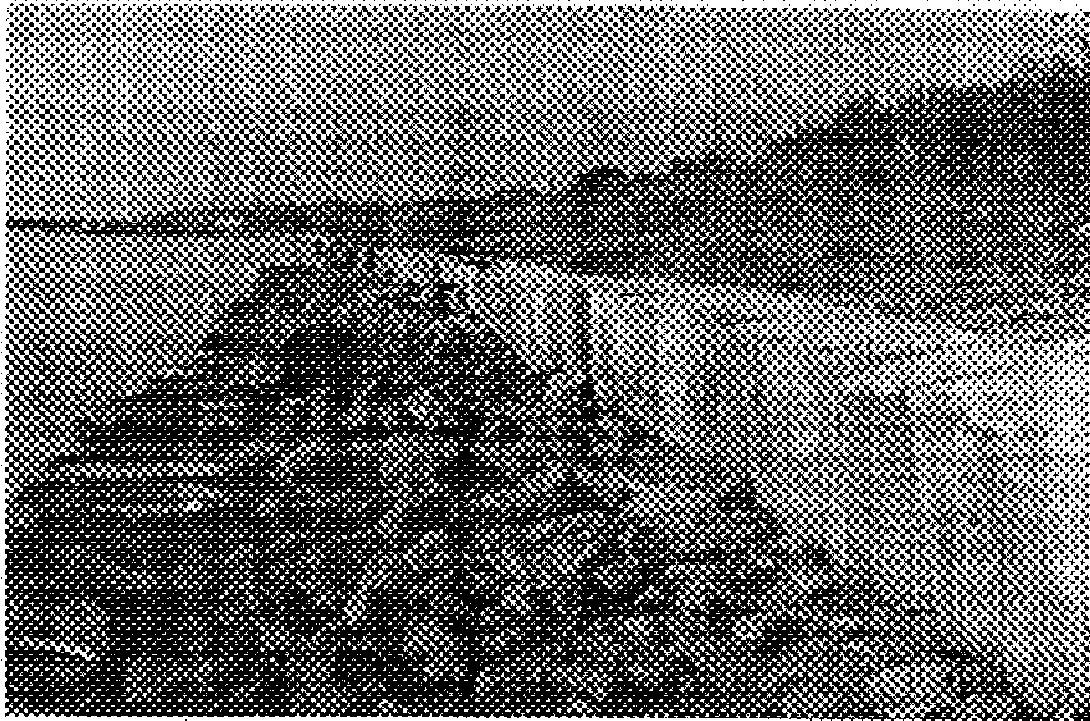

Figure D-23. Used concrete pipe bulkhead, Beach City, TX

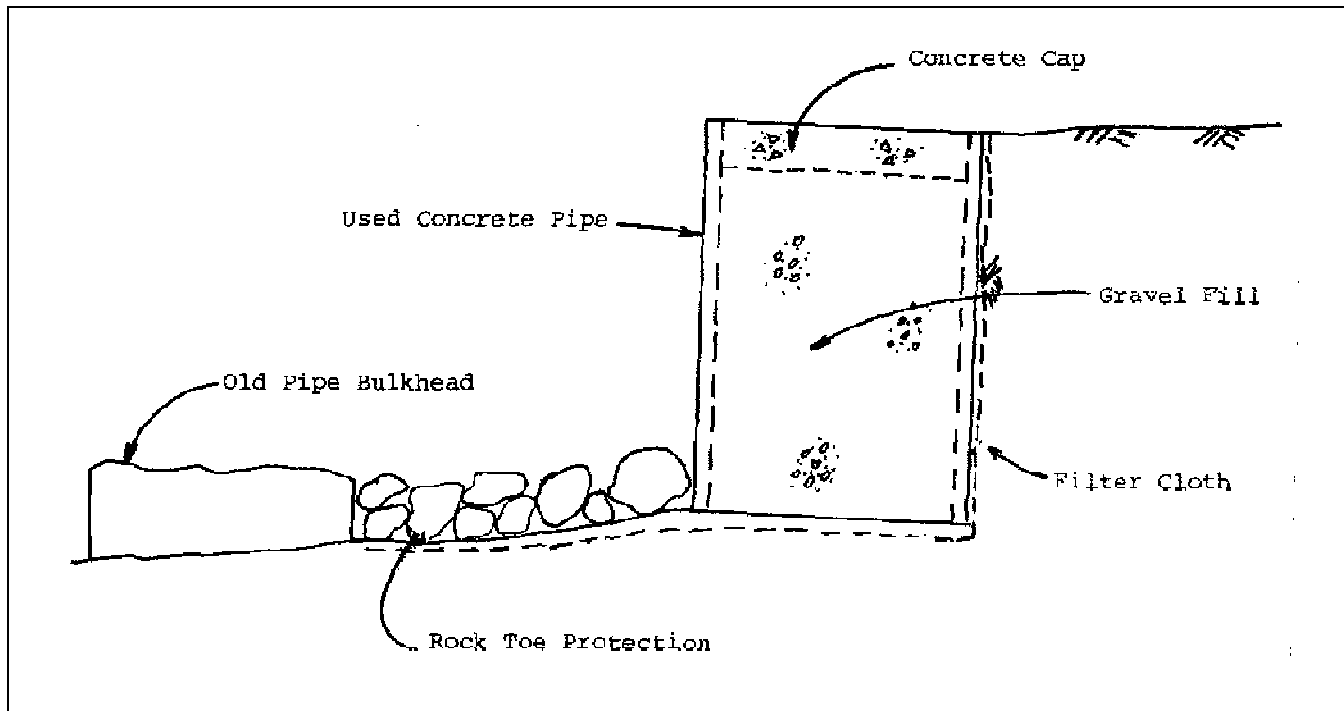

Figure D-24. Used concrete pipe bulkhead cross section

previous device that was built using 18- to 36-in. pipes which was destroyed during Hurricane Carla. As originally built, the structure had no toe protection or filtering system, and the fill within the pipes was not protected. As a result of a July 1979 storm, several pipes were damaged, and some backfill was lost from behind the pipes. Repairs included a concrete cap to protect the pipe fill, cement grouting of the gaps between pipes, and placement of broken concrete toe protection. Subsequent damages to the structure were limited. Fortunately, the relatively low height of the structure precluded damages that would have occurred in taller structures due to the excess hydrostatic pressures that could have developed by blocking the gaps between the pipes with concrete. Use of filter cloth or gravel filter during initial construction would have been a preferred method.

#### D-18. Longard Tubes

*a. General.* Longard tubes are patented, woven, polyethylene tubes that are hydraulically filled with sand and available in 40- and 69-in. diameters and lengths up to 328 ft. Placement is usually on a woven filter cloth that extends 10 ft seaward of the tube. A small 10-in. tube, factory-stitched to the seaward edge of the filter cloth, settles under wave action to provide toe protection. The primary advantage of a Longard tube is the ease and

speed of construction once equipment and materials are in place. Repairs can be made with sewn-on patches. The major disadvantage is vulnerability to vandalism and damage by waterborne debris. A sand-epoxy coating can be applied to dry tubes after filling to provide significantly greater puncture resistance. This coating cannot be applied in the wet.

*b. Design considerations.* Tubes can protect a bank toe against wave attack but have little resistance to large earth pressures. Tubes should not be placed directly at a bluff toe because wave overtopping may continue to cause erosion.

*c. Prototype installation (Figures D-25 and D-26).* Two types of Longard tube bulkheads were built near Ashland, WI, along the shore of Lake Superior, at the base of a 60- to 80-ft bluff (final report on Shoreline Erosion Control Demonstration Program). One was a 69-in. tube topped with a 40-in. tube. A concrete grout wedge was placed between the tubes to help resist overturning. The other structure was a single 69-in. tube. Earth pressures caused the 69-in. tubes to slide or roll lakeward and the 40-in. tube on one device to roll backward and fall behind. Overtopping waves continued to erode the bluff toe, and floating debris caused punctures

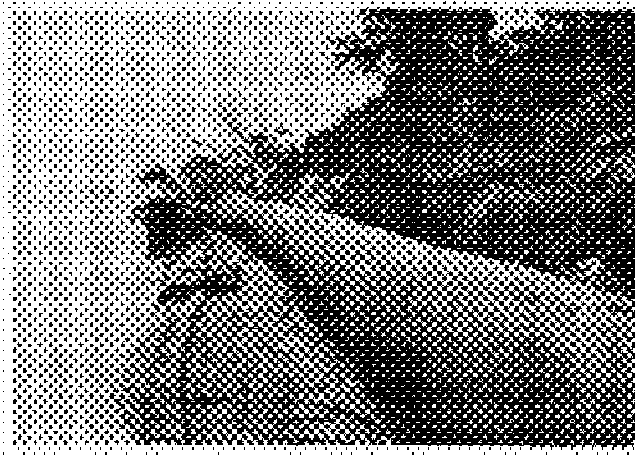

Figure D-25. Longard tube bulkhead, Ashland, WI

in several locations. These continued to enlarge and eventually caused a significant loss of sand fill from within the tubes. This was true despite the sand-epoxy coating. Placement of the tubes away from the bluff toe may have resulted in better performance.

### D-19. Stacked Bags

*a. General.* The uses of bags for revetments was discussed in paragraph B-19. Similar considerations apply to bulkhead construction, except that the bags are stacked vertically and are used to retain a backfill.

*b. Prototype installations.* No examples are known. The cross section and discussion of the hogwire fence and sandbag bulkhead (paragraph D-12) would generally apply here except that no fencing would be used. A possible section is shown in Figure D-27.

### D-20. Gabions

*a. General.* The use of gabions for revetments was discussed in paragraph B-20. Gabions can also be stacked vertically to construct bulkheads. These can be stepped up a slope, or the structure face can be placed at a small inclination to increase stability. Toe protection can be provided by extending baskets out along the bottom a distance sufficient to provide a cutoff in the event of scour. The structure must be stable against sliding and rotation considering any eroded depth at the toe.

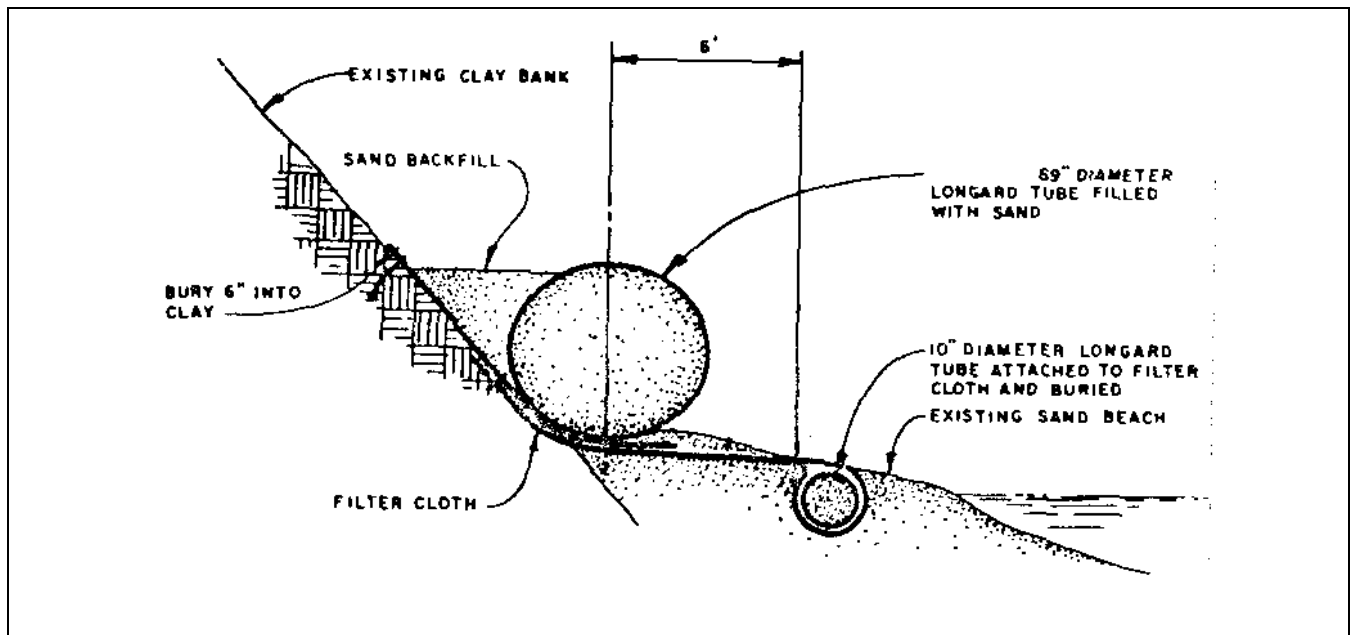

Figure D-26. Longard tube bulkhead cross section

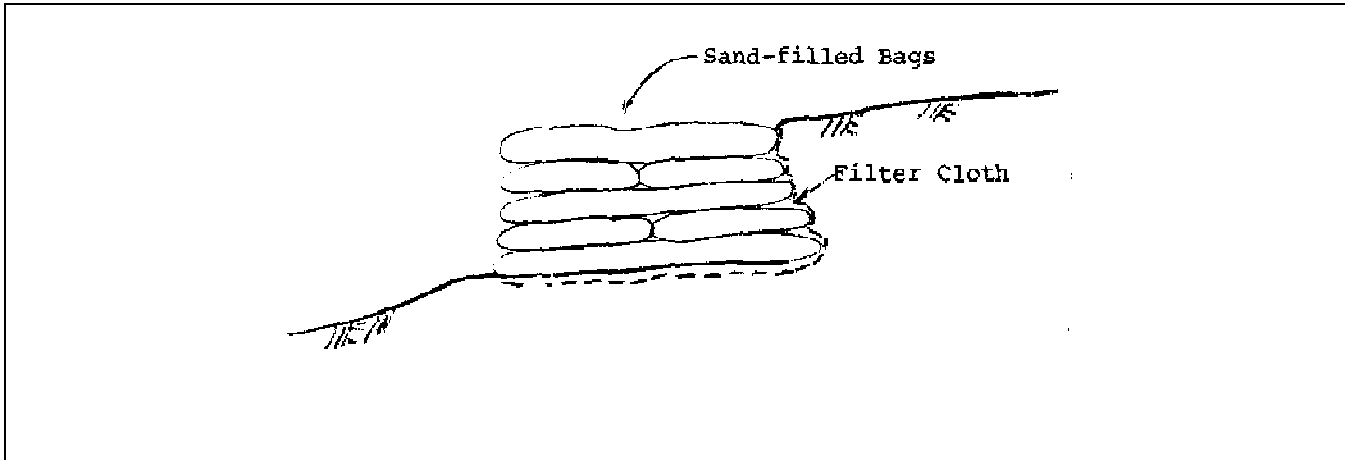

Figure 27. Stacked bag bulkhead cross section

b. *Prototype installations.* Details on specific sites are unavailable. A photo of an unidentified structure is shown in Figure D-28 along with a possible cross section in Figure D-29.

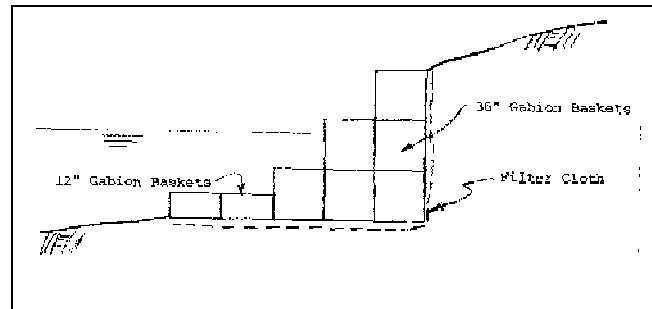

Figure D-29. Gabion bulkhead cross section

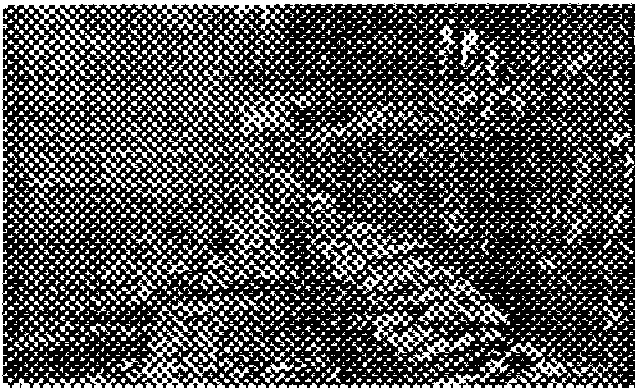

Figure D-28. Gabion bulkhead, possibly at Sand Point, MI



## Appendix E Sample Problem

### E-1. General

The site conditions shown in Figure E-1 are as follows: design wave height  $H$  is 4.20 ft, and design wave period  $T$  is 4.25 sec. A range of possible options will be considered.

### E-2. Selection of Alternatives

*a. Revetments.* Assume that the existing slope can be regraded to a 1V on 2H slope for revetment construction. Armoring options selected from Appendix B will be riprap, quarystone, concrete blocks, gabions, and soil cement.

*b. Seawalls.* Design wave conditions at this site are too mild to warrant massive seawall construction.

*c. Bulkheads.* Full height retention of the bank is possible using nearly all of the alternatives in Appendix D. Steel sheetpiling, H-piles and railroad ties, and gabions will be selected for comparison.

### E-3. Revetment Design

*a. Breaking wave criteria.* Check the given wave conditions against the maximum breaker height at the site.

$$d_s = 4.91 - 1.00 = 3.91 \text{ ft}$$

$$T = 4.25 \text{ sec}$$

$$m = 0.10 \text{ (nearshore bottom slope)}$$

$$\frac{d_s}{gT^2} = 0.0067$$

from Figure 2-2

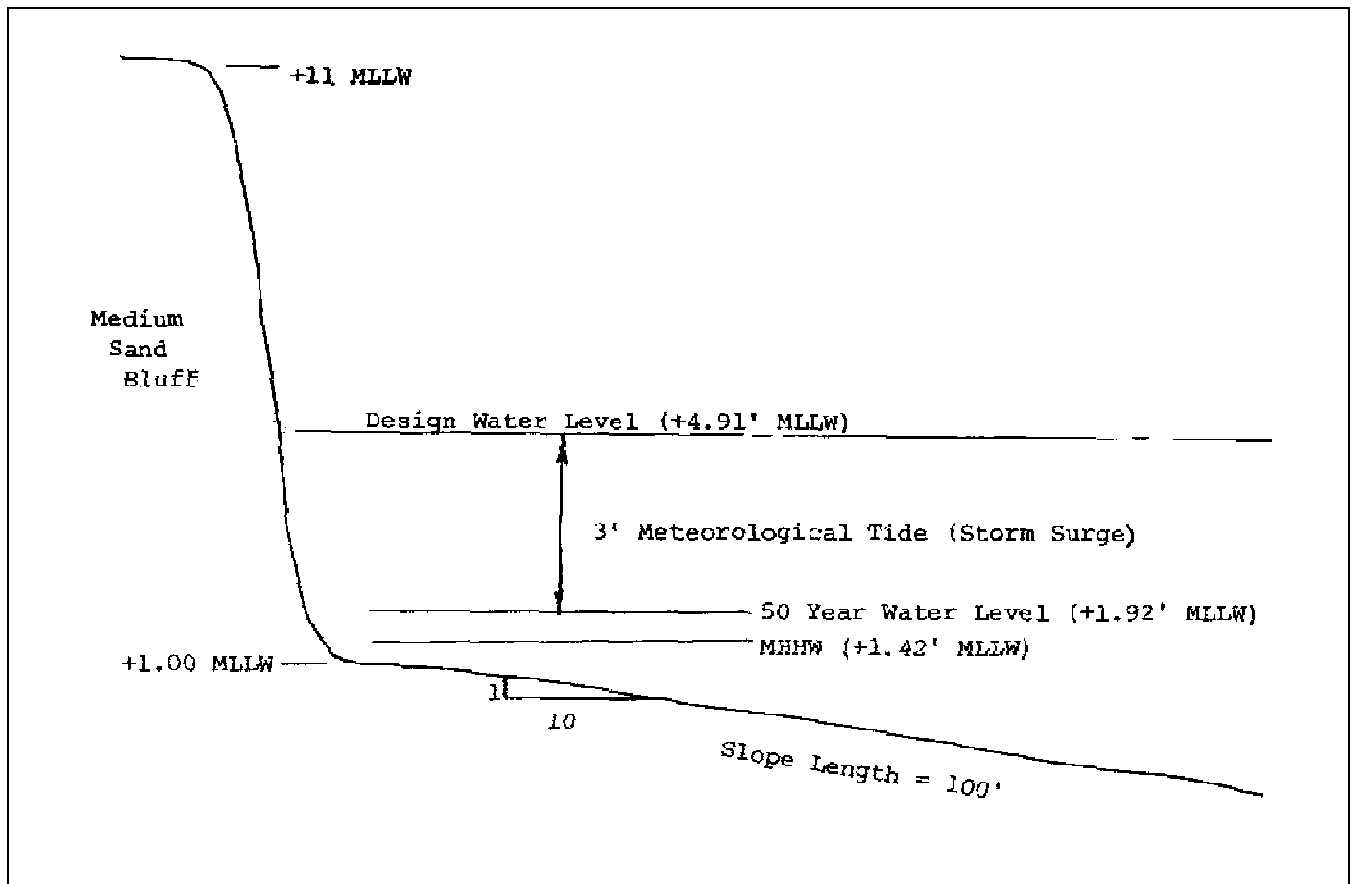

Figure E-1. Site conditions for sample problem

$$\frac{H_b}{d_s} = 1.45$$

$$\therefore H_b = 1.45 \times 3.91 = 5.67 \text{ ft} > 4.20 \text{ ft } (H)$$

$\therefore$  Use  $H = 4.20$  ft for design

b. Armor size determination.

(1) Riprap.

$$H = 4.20 \text{ ft}$$

$$T = 4.25 \text{ sec}$$

$$\cot \theta = 2.0$$

$$\gamma_r = 165 \text{ lb/ft}^3$$

$$K_D = 2.2 \text{ (Table 2.3)}$$

$$\gamma_w = 64 \text{ lb/ft}^3$$

from Equation 2-15:

$$\begin{aligned} W_{50} &= \frac{\gamma_r H^3}{K_D \left( \frac{\gamma_r}{\gamma_w} - 1 \right)^3 \cot \theta} \\ &= \frac{(165 \text{ lb/ft}^3)(4.20 \text{ ft})^3}{2.2 \left( \frac{165 \text{ lb/ft}^3}{64 \text{ lb/ft}^3} - 1 \right)^3 2.0} \\ &= 705 \text{ lb} \end{aligned}$$

Graded riprap this large may be difficult to obtain economically. Try rough, angular quarrystone, two layers thick ( $n = 2$ ).

(2) Quarrystone.

$$K_D = 2.0 \text{ (Table 2.3)}$$

from Equation 2-15:

$$\begin{aligned} W &= \frac{\gamma_r H^3}{K_D \left( \frac{\gamma_r}{\gamma_w} - 1 \right)^3 \cot \theta} \\ &= \frac{(165 \text{ lb/ft}^3)(4.20 \text{ ft})^3}{2.0 \left( \frac{165 \text{ lb/ft}^3}{64 \text{ lb/ft}^3} - 1 \right)^3 2.0} \\ &= 780 \text{ lb} \end{aligned}$$

The suggested gradation is 0.75  $W$  to 1.25  $W$ , or 585 lb to 975 lb with 50 percent  $> W$  (780 lb).

From Equation 2-22, the armor layer thickness  $r$  for  $n = 2$  is

$$k_\Delta = 1.00 \text{ (Table 2-4)}$$

$$\begin{aligned} r &= nk_\Delta \left( \frac{W}{\gamma_r} \right)^{1/3} \\ &= (2)(1.00) \left( \frac{780 \text{ lb}}{165 \text{ lb/ft}^3} \right)^{1/3} \\ &= 3.4 \text{ ft} \end{aligned}$$

From Equation 2-23, the number of quarrystones  $N_r$  per area (use  $A = 1,000 \text{ ft}^2$ ) is

$$P = 37 \text{ percent (Table 2-4)}$$

$$\begin{aligned} N_r &= Ank_\Delta \left( 1 - \frac{P}{100} \right) \left( \frac{\gamma_r}{W} \right)^{2/3} \\ &= (1,000 \text{ ft}^2)(2)(1.00) \left( 1 - \frac{37}{100} \right) \left( \frac{165 \text{ lb/ft}^3}{780 \text{ lb}} \right)^{2/3} \\ &= 450 \text{ stones per } 1,000 \text{ ft}^2 \end{aligned}$$

(3) Concrete blocks. The various concrete blocks shown in Appendix B are suitable for wave heights of 4 ft and below. For some of them, however, waves larger than these are at their limit of stability. Due to the catastrophic mode of failure of such revetments, the use of a larger design wave such as  $H_{10}$  is recommended. Assuming the design wave is significant wave height  $H_s$ , Equation 2-1 gives  $H_{10}$  as

$$H_{10} \approx 1.27 H_s \approx (1.27)(4.20 \text{ ft}) \approx 5.33 \text{ ft}$$

For waves this large, mat-type units are preferred. Individually placed blocks should generally be avoided for large wave heights. However, concrete construction and concrete control blocks form a deep section that would probably be stable despite their relatively low weight/unit. Unfortunately, no reliable stability criteria exist for any of these units, and selection is purely by the judgment of the designer.

(4) Other revetment materials. Bags, filled either with sand or concrete, would probably not be stable under waves greater than 4 ft high. Gabions, laid on a slope, would have runup and overtopping values intermediate between smooth slopes and riprap; 18-in. gabions would probably be sufficient (size selected by judgment). Soil cement may be acceptable. Tire mats, landing mats, filter fabric, and concrete slabs would not be suitable due to the large wave heights.

*c. Filter requirements.*

(1) Quarrystone revetment. Assume that an analysis indicates that a two-stage stone filter will be required beneath the armor layer. The first underlayer will be 12 in. of crushed stone aggregates; the second layer will be 12 in. of pea gravel. A filter cloth (EOS = 70) may be substituted for the pea gravel underlayer.

(2) Block revetment. The block revetment will be underlain with a filter cloth as described above.

(3) Gabions. Assume that analysis shows that a single layer of pea gravel (12 in. thick) will be acceptable. An EOS = 70 filter cloth could also be used.

(4) Soil cement. There is no filtering requirement except that hydrostatic pressures should be relieved through regularly spaced drain pipes.

*d. Wave runup estimation.*

(1) Quarrystone. Assume that the design conditions given were for significant wave height and peak wave period in a depth of 15 ft. Use Equation 2-3 to find  $H_{mo}$ :

$$\frac{H_s}{H_{mo}} = \exp \left[ C_0 \left( \frac{d}{g T_p^2} \right)^{-C_1} \right]$$

$$\frac{4.20 \text{ ft}}{H_{mo}} = \exp \left[ 0.00089 \left( \frac{15 \text{ ft}}{(32.2 \text{ ft/sec}^2)(4.25 \text{ sec})^2} \right)^{-0.834} \right]$$

$$\frac{4.20 \text{ ft}}{H_{mo}} = 1.019$$

$$H_{mo} = 4.12 \text{ ft}$$

Maximum runup is found from Equations 2-6 and 2-7:

$$\begin{aligned} \xi &= \frac{\tan \theta}{\left( \frac{2\pi H_{mo}}{g T_p^2} \right)^{1/2}} \\ &= \frac{0.5}{\left[ \frac{(2)(\pi)(4.12 \text{ ft})}{(32.2 \text{ ft/sec}^2)(4.25 \text{ sec})^2} \right]^{1/2}} \end{aligned}$$

$$= 2.37$$

$$\frac{R_{\max}}{H_{mo}} = \frac{a\xi}{1 + b\xi}$$

$$\frac{R_{\max}}{4.12 \text{ ft}} = \frac{(1.022)(2.37)}{1 + (0.247)(2.37)}$$

$$= 1.53$$

$$R_{\max} = (4.12 \text{ ft})(1.53)$$

$$= 6.29 \text{ ft}$$

(2) Blocks. The values shown in Table 2-2 indicate that runup will be higher for blocks than for quarrystone.

From Table 2-2, assume a value for a slope of  $\cot \theta = 2.0$  between the values given for  $\cot \theta = 1.5$  and  $\cot \theta = 2.5$ . The adjustment to maximum runup value is made as follows:

$$r(\text{blocks}) = 0.93$$

$$r(\text{quarrystone}) \approx 0.61$$

$$R_{\max}(\text{blocks}) = R_{\max}(\text{quarrystone})$$

$$\left[ \frac{r(\text{blocks})}{r(\text{quarrystone})} \right] = 6.29 \text{ ft} \left( \frac{0.93}{0.61} \right) = 9.59 \text{ ft}$$

(3) Gabions. For runup on gabions, use a runup correction factor intermediate between quarrystone and blocks such a  $r = 0.77$ . Maximum runup is determined as above for concrete blocks:

$$r(\text{gabions}) = 0.77$$

$$r(\text{quarrystone}) \approx 0.61$$

$$R_{\max}(\text{gabions}) = R_{\max}(\text{quarrystone})$$

$$\left[ \frac{r(\text{gabions})}{r(\text{quarrystone})} \right] = 6.29 \text{ ft} \left( \frac{0.77}{0.61} \right) = 7.69 \text{ ft}$$

(4) Soil cement. Use a riser height of 2.5 ft for a stepped slope. Runup correction factors in Table 2-2 are valid for  $1 \leq H_o'/K_r$ .  $H_o'$  is the deepwater wave height. Because the design  $H$  is assumed to be given in a depth of 15 ft, the wave will have shoaled from deepwater to the 15-ft depth. To determine the deepwater wave height, apply the shoaling coefficient given in Equation 2-44 of the SPM or use ACES. The wavelength for a 4.25-sec wave in a 15-ft depth is 77.56 ft (ACES or SPM Appendix C).

$$\tanh\left(\frac{2\pi d}{L}\right) = \tanh\left[\frac{2\pi(15 \text{ ft})}{77.56 \text{ ft}}\right] = 0.838$$

$$\frac{4\pi d}{L} = \frac{4\pi(15 \text{ ft})}{77.56 \text{ ft}} = 2.43$$

$$\sinh\left(\frac{4\pi d}{L}\right) = \sinh(2.43) = 5.64$$

$$\begin{aligned} \frac{H}{H_o'} &= \sqrt{\frac{1}{\tanh\left(\frac{2\pi d}{L}\right)} \left[ 1 + \frac{\left(\frac{4\pi d}{L}\right)}{\sinh\left(\frac{4\pi d}{L}\right)} \right]} \\ &= \sqrt{\frac{1}{0.838} \left[ 1 + \frac{2.43}{5.64} \right]} = 0.913 \\ H_o' &= \frac{H}{0.913} = \frac{4.20 \text{ ft}}{0.913} = 4.60 \text{ ft} \end{aligned}$$

Using  $K_r = 2.5$  ft,

$$\frac{H_o'}{K_r} = \frac{4.60 \text{ ft}}{2.5 \text{ ft}} = 1.84$$

which is within the acceptable range. Therefore, determine the maximum runup as:

$$r(\text{vertical risers}) = 0.75$$

$$r(\text{quarrystone}) \approx 0.61$$

$$R_{\max}(\text{vertical risers}) = R_{\max}(\text{quarrystone})$$

$$\left[ \frac{r(\text{vertical risers})}{r(\text{quarrystone})} \right] = 6.29 \text{ ft} \left( \frac{0.75}{0.61} \right) = 7.73 \text{ ft}$$

(5) Runup summary. The required top elevation to preclude overtopping is the design water level plus the predicted runup. These values are given in Table E-1.

The top of the bank is at +11 ft mllw; therefore, overtopping should be considered. A splash apron should be provided for those alternatives, and drainage of the excess water may be necessary. Overtopping rates were covered in paragraph 2-14 and in Section 7.22 of the SPM. These rates should be determined to properly design any required drainage features, but this will not be investigated in this example.

**Table E-1**  
**Predicted Runup and Required Crest Elevations for Sample Revetment Options**

Structure	Water Level, ft	Runup, ft	Crest Elevation, ft
Quarrystone	4.91	6.29	11.20 ≈ 11.25
Concrete blocks	4.91	9.59	14.50
Gabions	4.91	7.69	12.6 ≈ 12.50
Soil cement	4.91	7.73	12.64 ≈ 12.50

*e. Toe scour.* The toe scour depth below the natural bottom will be assumed equal to the wave height. The toe is exposed at mean lower low water (mllw). The maximum water depth is 3.91 ft at the design water level. From paragraph E-3a, the maximum breaker height at the design water level is 5.67 ft. The depth of toe scour should be estimated based on a wave larger than the significant design wave of 4.20 ft. In paragraph E-3b(3) it was found that  $H_{10} = 5.33$  ft. Therefore, assume that the maximum scour depth will be about 5 ft beneath the existing bottom. This is probably conservative in that it does not consider structure, shapes, or wave reflection properties. The minimum predicted scour depths are shown below in Table E-2. Rock toe protection or structure embedment will be at least the maximum depth except in the case of gabions where their flexibility will be relied on to cut off any toe scour that may occur.

*f. Design summary.* Design cross sections for each alternative are shown in Figure E-2. Table E-3 summarizes revetment design data.

#### E-4. Bulkhead Design

*a. Sheetpiling.* Cantilever or anchored sections are chosen based on standard structural design calculations. Important design considerations are wave runup and toe protection.

(1) Wave runup. Using SPM Figure 7-14 with

$$\frac{d_s}{H_o} = \frac{3.91 \text{ ft}}{4.60 \text{ ft}} = 0.85$$

$$\frac{H_o'}{gT^2} = \frac{4.60 \text{ ft}}{(32.2 \text{ ft/sec}^2)(4.25 \text{ sec})^2} = 0.0079$$

read from SPM Figure 7-14

$$\frac{R}{H_o} = 1.70$$

$$R = (H_o')(1.70) = 7.82 \text{ ft}$$

Correcting for scale effects with SPM Figure 7-13

$$R' = (1.21)(7.82 \text{ ft}) = 9.46 \text{ ft}$$

The required elevation of the top of the wall is therefore

$$4.91 \text{ ft} + 9.46 \text{ ft} = 14.37 \text{ ft mllw}$$

**Table E-2**  
**Estimated Toe Scour Depths for Sample Revetment Options**

Revetment Type	Scour Depth, ft		Reflection Potential
	Maximum	Minimum	
Quarrystone	5.0	2.5	Low
Concrete blocks	5.0	2.5	Low-Moderate
Gabions	5.0	4.0	Moderate-High
Soil cement	5.0	4.0	Moderate-High

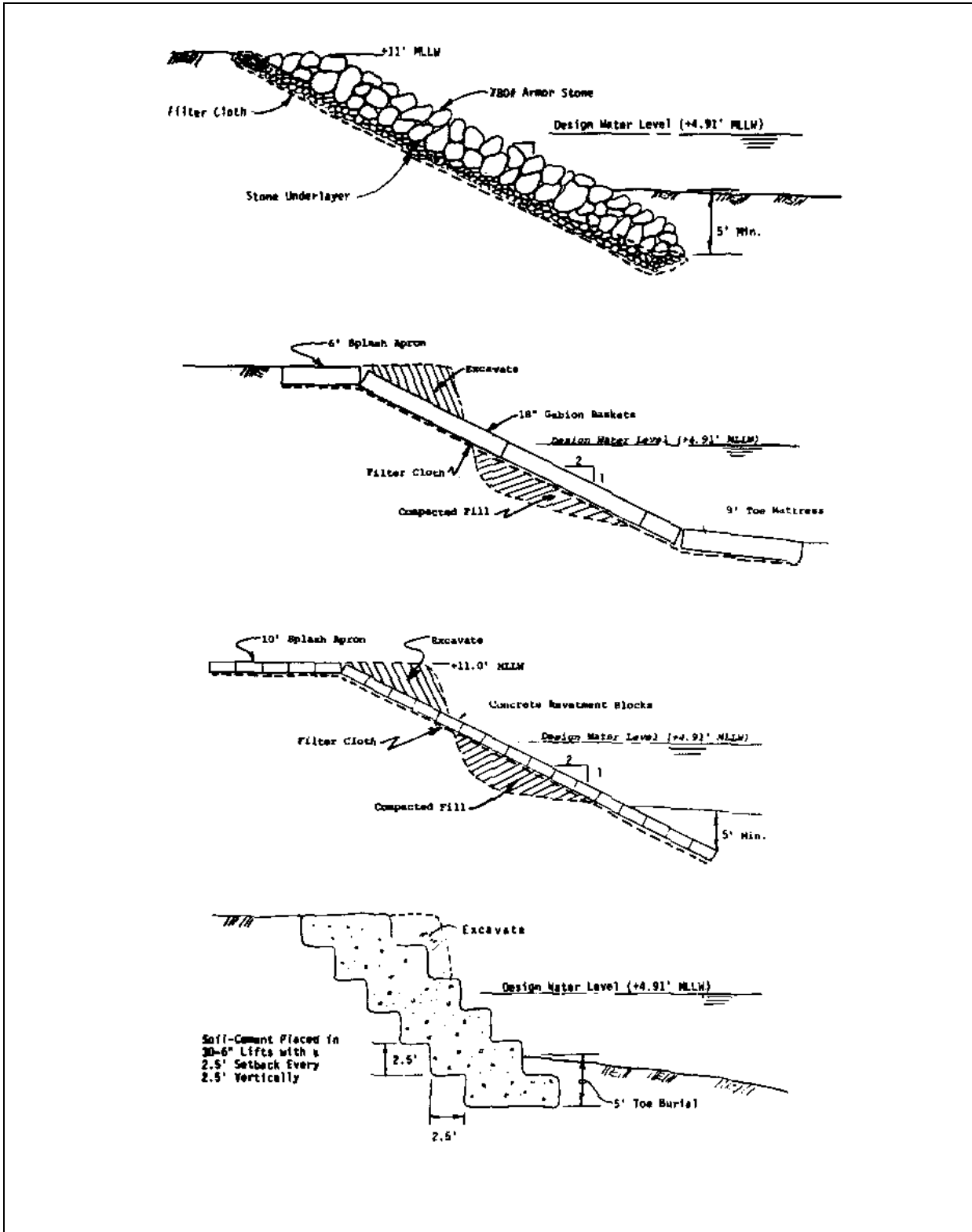

Figure E-2. Retention section alternatives

**Table E-3**  
**Summary of Revetment Design Options**

Revetment Type	Armor Size	Wave Height ft	Crest Elevation		Minimum Toe Scour ft
			Required ft	Actual ft	
Quarystone	780 lb	4.20	11.25	11.00	2.5
Concrete blocks	Note (1)	5.30	14.50	11.00	2.5
Gabions	18-in. baskets	4.20	12.50	11.00	4.0
Soil cement	Note (2)	4.20	12.50	11.00	4.0

- (1) Mats of concrete blocks will be used.  
(2) Layer thickness will be 2.5 ft.

Because the height of the shoreline is only 11.0 ft mllw, overtopping will occur and a splash apron should be provided.

(2) Toe protection. Under design water level conditions the toe will be submerged. The toe stone should be sized in accordance with Equation 2-15. Use the  $H_{10}$  wave height of 5.33 ft. Note that the actual slope of the toe protection would be nearly flat. Using  $\cot \theta = 3.0$  is conservative. The suggested gradation would be 0.75  $W$  to 1.25  $W$ , or 795 lb to 1,325 lb, with 50 percent greater than  $W$  (1,060 lb).

Layer thickness is determined from Equation 2-22 with  $n = 2$  and  $k_{\Delta} = 1.00$  (Table 2-4).

$$H_{10} = 5.33 \text{ ft}$$

$$\gamma_r = 165 \text{ lb/ft}^3$$

$$K_D = 2.0 \text{ (Table 2-3, rough, angular quarystone)}$$

$$\frac{\gamma_r}{\gamma_w} = \frac{165 \text{ lb/ft}^3}{64 \text{ lb/ft}^3} = 2.58$$

$$\cot \theta = 3.0$$

$$W = \frac{\gamma_r H^3}{K_D \left( \frac{\gamma_r}{\gamma_w} - 1 \right)^3 \cot \theta}$$

$$= \frac{(165 \text{ lb/ft}^3)(5.33 \text{ ft})^3}{2.0 \left( \frac{165 \text{ lb/ft}^3}{64 \text{ lb/ft}^3} - 1 \right)^3 3.0}$$

$$= 1,060 \text{ lb}$$

$$r = nk_{\Delta} \left( \frac{W}{\gamma_r} \right)^{1/3}$$

$$= (2)(1.00) \left( \frac{1,060 \text{ lb}}{165 \text{ lb/ft}^3} \right)^{1/3}$$

$$= 3.7 \text{ ft}$$

Assume an anchored section as shown in Figure E-3. The toe apron should protect the passive earth pressure zone but should be no less than twice the wave height. The width of the passive earth pressure zone is

$$\text{Width} = K_p d_e$$

$$= (2.46)(6.5 \text{ ft}) = 16 \text{ ft}$$

which assumes a soil  $\phi$  of 25 deg and a  $K_p$  value of 2.46. Use a 16-ft toe apron width, as this is longer than twice the wave height (5.33 ft x 2 = 10.66 ft).

*b. Other bulkhead materials.* Concrete slabs and king-piles are probably too expensive for all but very large installations. Railroad ties and steel H-piles are acceptable provided marine borer activity can be resisted by standard creosote-treated ties. The same is true for other timber structures. Hogwire fencing and sandbags are suitable for temporary structures, as are used rubber tires. Used concrete pipes cannot retain the full bluff height. Gabions can be stacked to almost any height needed in bluff situations. Figure E-3 contains sections of a railroad tie and H-pile bulkhead and a gabion bulkhead.

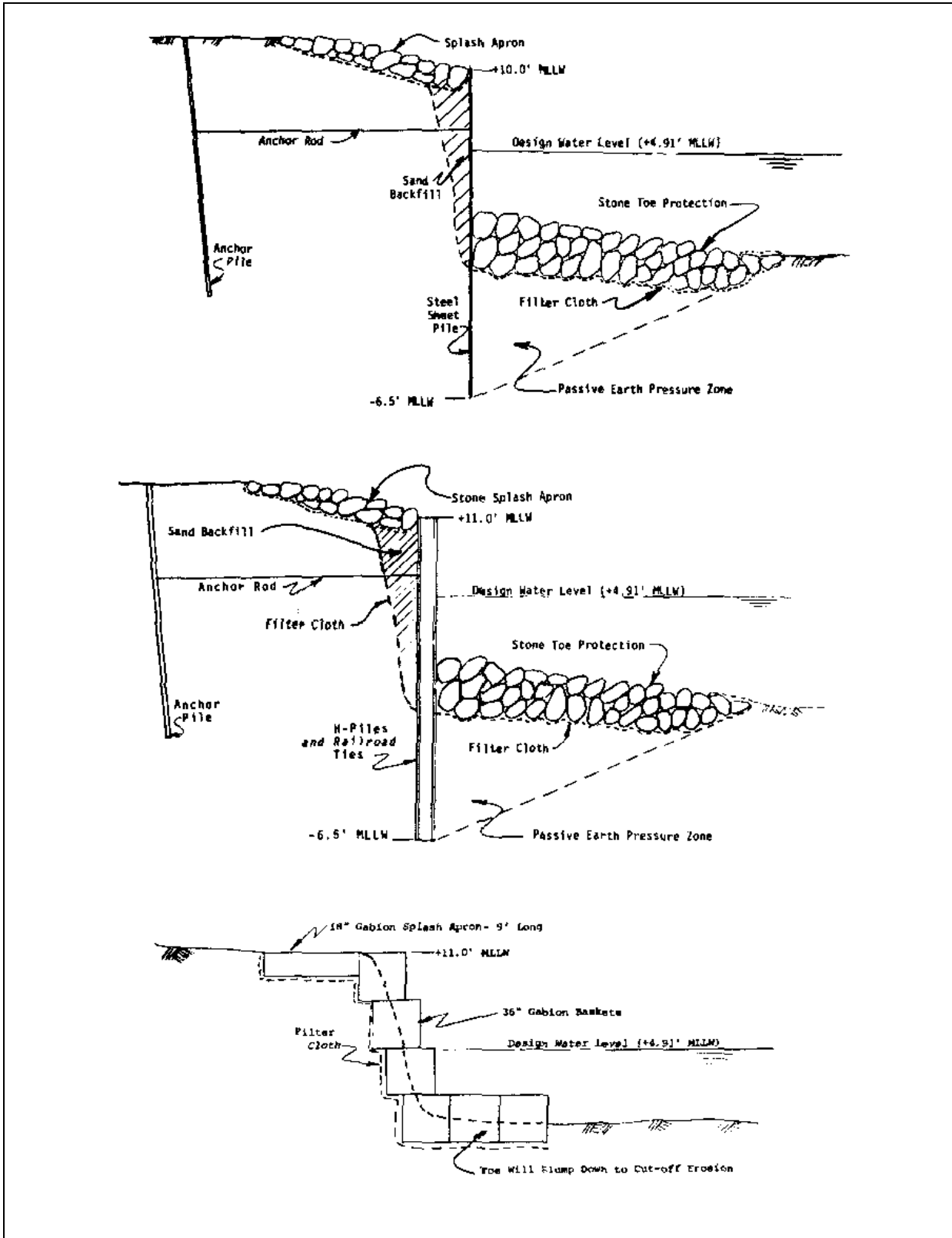

Figure E-3. Bulkhead section alternatives



Toe protection for the gabion bulkhead should extend horizontally for one wave height. Use 6 ft, which is the width of two of the 36-in. baskets shown in Figure E-3.

### E-5. Cost Estimates

Cost estimates will be developed for 1,000 lin ft of protection. These estimates are shown for illustrative purposes only and should not be interpreted as definitive of costs likely to be encountered at a specific project site. Costs of various options can vary significantly in different parts of the country depending on availability of materials and transportation charges. It is likely that the relative ranking of options (based on cost) for a particular project would be entirely different from the one developed here.

*a. Revetments.* Assume all revetments will be placed on a 1V to 2H slope achieved by grading the bluff face. Assume the site preparation costs shown in Table E-4.

(1) Quarystone. From paragraph E-3b(2), the layer thickness is 3.4 ft. The total stone volume is 4,300 yd<sup>3</sup> (including the embedded toe). Underlayers will be 12 in. of crushed stone over 12 in. of pea gravel or 12 in. of crushed stone over a filter cloth. Costs of these items are shown in Table E-5.

(2) Concrete blocks. Use a typical mat material that is commercially available. Place it over a filter cloth with

**Table E-4**  
**Site Preparation Costs for Revetment Alternative**

Item	Quantity	Unit Cost, \$	Total Cost, \$
Site clearing	0.3 acre	3,000	900
Excavation	3,700 yd <sup>3</sup>	2.25	8,325
Grading	2,500 yd <sup>2</sup>	0.50	1,250
Total			\$10,475

**Table E-5**  
**Material Costs for Armor Stone Revetment Alternative**

Item	Quantity	Unit Cost, \$	Total Cost, \$
Armor stone	4,300 yd <sup>3</sup>	60.00	258,000
12-in. crushed stone	3,745 yd <sup>2</sup>	4.35	16,275
12-in. pea gravel	3,745 yd <sup>2</sup>	2.95	11,050
Filter cloth	36,830 ft <sup>2</sup>	0.25	9,200
Toe excavation	720 yd <sup>3</sup>	2.25	1,625
Total using filter cloth			\$285,100

a 10-ft-wide splash apron. Item costs are shown in Table E-6.

(3) Gabions. Use 18-in. baskets with a 9-ft-wide toe blanket and a 6-ft-wide splash apron. Place them over a filter cloth or 12 in. of pea gravel. Material costs for this option are shown in Table E-7.

(4) Soil cement. Place in 31 6-in. lifts, with each lift being 6 ft wide. Final grading will not be required for site preparation. Material costs for this option are listed in Table E-8.

(5) Revetment summary. Table E-9 contains a summary of initial costs for the four revetment options.

**Table E-6**  
**Material Costs for Concrete Block Revetment Alternative**

Item	Quantity	Unit Cost, \$	Total Cost, \$
Block mat	43,700 ft <sup>2</sup>	3.25	142,025
Filter cloth	43,700 ft <sup>2</sup>	0.25	10,925
Toe excavation	720 yd <sup>3</sup>	2.25	1,620
Total			\$154,570

**Table E-7**  
**Material Costs for Gabion Revetment Option**

Item	Quantity	Unit Cost, \$	Total Cost, \$
Gabions	4,155 yd <sup>2</sup>	35.00	145,425
12-in. pea gravel	4,155 yd <sup>2</sup>	2.95	12,260
Filter cloth	37,400 ft <sup>2</sup>	0.25	9,350
Total using filter cloth			\$154,775

**Table E-8**  
**Material Costs for Soil-Cement Revetment Option**

Item	Quantity	Unit Cost, \$	Total Cost, \$
Backfill	3,700 yd <sup>3</sup>	1.00	3,700
Soil-cement treatment	20,665 yd <sup>2</sup>	2.90	59,930
Compaction	3,700 yd <sup>3</sup>	4.00	14,800
Toe excavation	1,000 yd <sup>3</sup>	2.25	2,250
Total			\$80,680

**Table E-9**  
**Summary of Initial Costs for the Revetment Options**

Option	Site Preparation, \$	Construction, \$	Total Cost, \$
Quarystone	10,475	285,100	295,575
Concrete blocks	10,475	154,570	165,045
Gabions	10,475	154,775	165,250
Soil cement	9,225	80,680	89,905

b. *Bulkheads.* Assume only site clearing is required for preparation. From Table E-4, total site preparation cost is \$900.

(1) Steel sheetpiling. Assume a 10-ft height plus a 6.5-ft embedded length for an anchored wall. Use 1,055-lb stones for toe protection. Material costs are listed in Table E-10.

(2) Railroad ties and steel H-piles. Use 1,055-lb stones for toe and splash protection. Material costs are listed in Table E-11.

(3) Gabions. Use 36-in. baskets with a 9-ft toe blanket and a 6-ft splash apron of 18-in. baskets. Material costs are listed in Table E-12.

(4) Bulkhead summary. Table E-13 contains a summary of initial costs for the three bulkhead options.

c. *Annual costs.* Compute annual costs based on a federal discount rate (7-7/8 percent for this example) and annual maintenance costs equal to the given percentage of the initial cost. All options are based on a 50-yr life. The annual costs are summarized in Table E-14.

d. *Summary.* Based on total annual costs, the gabion bulkhead would be most economical at this site, followed closely by the soil-cement revetment. The environmental and social impacts must also be considered before a final design is selected.

**Table E-10**  
**Material Costs for Steel Sheetpile Bulkhead Option**

Item	Quantity	Unit Cost, \$	Total Cost, \$
Sheetpiling	16,500 ft <sup>2</sup>	11.00	181,500
10-ft anchor piles and anchor rods	200 ft	14.00	2,800
Toe protection	2,975 yd <sup>3</sup>	60.00	178,500
Splash apron	820 yd <sup>3</sup>	60.00	49,200
Filter cloth	26,000 ft <sup>2</sup>	0.25	6,500
Backfill	100 yd <sup>3</sup>	1.00	100
Total			\$418,600

**Table E-11**  
**Material Costs for Railroad Ties and Steel H-Pile Bulkhead Option**

Item	Quantity	Unit Cost, \$	Total Cost, \$
25-ft steel H-piles	117 ea	500.00	58,500
Railroad ties	1,950 ea	40.00	78,000
Filter cloth	1,000 ft <sup>2</sup>	0.25	250
Backfill	100 yd <sup>3</sup>	1.00	100
Toe protection	2,975 yd <sup>3</sup>	60.00	178,500
Splash apron	820 yd <sup>3</sup>	60.00	49,200
Total			\$364,550

**Table E-12**  
**Material Costs for Gabion Bulkhead Option**

Item	Quantity	Unit Cost, \$	Total Cost, \$
Gabions, 36-in. baskets	2,000 yd <sup>3</sup>	60.00	120,000
Gabions, 18-in. baskets	670 yd <sup>2</sup>	35.00	23,450
Filter cloth	31,650 ft <sup>2</sup>	0.25	7,925
Backfill	100 yd <sup>3</sup>	1.00	100
Total			\$151,475

**Table E-13**  
**Summary of Initial Costs for the Bulkhead Options**

Option	Site Preparation, \$	Construction, \$	Total Cost, \$
Steel sheetpiling	900	418,600	419,500
Railroad ties and steel H-piles	900	364,550	365,450
Gabions	900	151,475	152,375

**Table E-14**  
**Summary of Annual Costs for Revetment and Bulkhead Options**

Option	Total Initial Cost, \$	Capital Recovery Cost, \$	Maintenance (Annual %)	Annual Maintenance Cost, \$	Total Annual Cost, \$
<b>Revetments</b>					
Quarrystone	295,575	23,270	1	2,955	26,225
Concrete blocks	165,045	12,910	5	8,250	21,160
Gabions	165,250	12,930	5	8,260	21,190
Soil-cement	89,905	7,030	15	13,490	20,520
<b>Bulkheads</b>					
Steel sheetpiling	419,500	32,820	1	4,200	37,020
Railroad ties and steel H-piles	365,450	28,590	5	18,270	46,860
Gabions	152,375	11,920	5	7,620	19,540

**Appendix F  
Glossary**

<u>Symbol</u>	<u>Units</u>	<u>Term</u>	<u>Symbol</u>	<u>Units</u>	<u>Term</u>
			$H_{mo}$	ft	Wave height of zeroth moment of wave spectrum
$a$		Regression coefficient	$H_o'$	ft	Unrefracted deepwater wave height
$b$		Regression coefficient	$H_s$	ft	Significant wave height
$B$	ft	Minimum toe apron depth	$H_1$	ft	Average of highest 1 percent of all waves
$C_0$		Regression coefficient	$H_{10}$	ft	Average of highest 10 percent of all waves
$C_1$		Regression coefficient	$i$	in./in.	Hydraulic gradient
$C_2$		Regression coefficient	$i_1$	in./in.	Hydraulic gradient through filter fabric and the 1 in. of soil immediately above it
$d_e$	ft	Embedment depth below the natural bottom for a sheetpile bulkhead	$i_2$	in./in.	Hydraulic gradient through soil located between 1 and 3 in. above filter fabric
$d_s$	ft	Water depth at a structure	$k_{\Delta}$		Empirical armor layer thickness
$d_1$	ft	Vertical distance from the still-water level to the top of the toe stone	$K_D$		Empirical armor unit stability coefficient
$d_{15}$	ft, mm	15 percent passing size of a soil or rock gradation	$K_r$	ft	Characteristic armor unit size
$d_{50}$	ft, mm	Equivalent spherical diameter of the median particle in a gradation	$K_1$		Empirical toe stone stability coefficient
$d_{85}$	ft, mm	85 percent passing size of a soil or rock gradation	$L_o$	ft	Deepwater wavelength
$h$	ft	Height of a structure crest above the bottom	$m$	ft/ft	Nearshore bottom slope (ratio of H/V)
$h_s$	ft	Height of a bulkhead crest above the original existing bottom	$n$		Number of equivalent spherical diameters of armor stone corresponding to the median stone weight that could fit within the layer thickness
$H$	ft	(a) Wave height  (b) Horizontal dimension used in designating slope	$N_r$		Number of armor stones per unit surface area
$H_b$	ft	Maximum breaker height	$P$		Porosity of an armor layer
$H_{D=0}$	ft	Zero-damage wave height for armor stability determination	$Q$	cfs/ft	Wave overtopping rate

<u>Symbol</u>	<u>Units</u>	<u>Term</u>	<u>Symbol</u>	<u>Units</u>	<u>Term</u>
$r$	ft	(a) Armor unit layer thickness	$W_{15 \text{ max}}$	lb	Upper limit of the $W_{15}$ stone weight for a riprap gradation
		(b) Rough slope runup correction factor	$W_{15 \text{ min}}$	lb	Lower limit of the $W_{15}$ stone weight for a riprap gradation
$r_{\text{min}}$	ft	Minimum riprap layer thickness	$W_{50}$	lb	Median stone weight of a riprap gradation
$R$	ft	Wave runup height above the still water level	$W_{50 \text{ max}}$	lb	Maximum median stone weight of a riprap gradation
$R_{\text{max}}$	ft	Maximum wave runup height above the still water level	$W_{50 \text{ min}}$	lb	Minimum median stone weight of a riprap gradation
$S_r$		Specific gravity of armor unit	$W_{100}$	lb	Largest permissible stone weight within a riprap gradation
$T$	sec	Wave period	$W_{100 \text{ max}}$	lb	Upper limit of the $W_{100}$ stone weight of a riprap gradation
$T_p$	sec	Wave period of peak energy density of the wave spectrum	$W_{100 \text{ min}}$	lb	Lower limit of the $W_{100}$ stone weight of a riprap gradation
$T_s$	sec	Average wave period of highest 1/3 of all waves	$\gamma_r$	lb/ft <sup>3</sup>	Unit weight of armor stone or armor unit
$T_z$	sec	Average wave period of a wave spectrum	$\gamma_w$	lb/ft <sup>3</sup>	Unit weight of water
$V$	ft	(a) Vertical dimension of a slope	$\theta$	deg, rad	Angle of a slope measured from the horizontal
	ft/sec	(b) Current velocity across the toe of a structure	$\phi$	deg	Angle of internal friction of soil or rubble
$W$	lb	Armor unit weight			
$W_{15}$	lb	15 percent passing size of a riprap gradation			