

# Water Quality Effects of an Intake Barrier Curtain to Reduce Algae Concentrations Downstream of Iron Gate Reservoir

Prepared for:



Portland, Oregon

Prepared by:

Watercourse Engineering, Inc.  
424 Second Street, Suite B  
Davis, California 95616

July 2016





# CONTENTS

Section	Page
<b>ACRONYMS AND ABBREVIATIONS</b> .....	<b>VII</b>
<b>EXECUTIVE SUMMARY</b> .....	<b>ES-1</b>
<b>1 INTRODUCTION</b> .....	<b>1-1</b>
<b>2 DESCRIPTION OF INTAKE BARRIER CURTAIN</b> .....	<b>2-1</b>
<b>3 STUDY ACTIVITIES</b> .....	<b>3-1</b>
3.1 DATA SONDE DEPLOYMENT .....	3-2
3.1.1 Methodology .....	3-3
3.1.2 Results .....	3-3
3.1.3 Summary .....	3-7
3.2 BIMONTHLY GRAB SAMPLING .....	3-7
3.2.1 Methodology .....	3-7
3.2.2 Results .....	3-8
3.2.3 Summary .....	3-23
3.3 MULTIDAY, SHORT-TERM AUTOSAMPLING .....	3-24
3.3.1 Methodology .....	3-24
3.3.2 Results .....	3-25
3.3.3 Summary .....	3-33
3.4 VERTICAL PROFILING UPSTREAM AND DOWNSTREAM OF CURTAIN .....	3-33
3.4.1 Methodology .....	3-33
3.4.2 Results .....	3-34
3.4.3 Summary .....	3-37
3.5 ACOUSTIC DOPPLER CURRENT PROFILING .....	3-38
3.5.1 Methodology .....	3-38
3.5.2 Results .....	3-40
3.5.3 Summary .....	3-43
3.6 PHYSICAL PARAMETER PROFILING DOWNSTREAM OF CURTAIN .....	3-43
3.6.1 Methodology .....	3-43
3.6.2 Results .....	3-44
3.6.3 Summary .....	3-46
<b>4 POTENTIAL WIND EFFECTS</b> .....	<b>4-1</b>
4.1 WEDDERBURN NUMBER .....	4-1
4.2 THERMOCLINE TILT .....	4-3
<b>5 CONCLUSIONS</b> .....	<b>5-1</b>
<b>6 REFERENCES</b> .....	<b>6-1</b>

## Tables

1	Summary of Microcystin Concentrations in Samples Taken During Multiday Autosampler Experiment. ....	3-26
2	Summary of <i>Microcystis aeruginosa</i> Cell Counts (cells/mL) in Samples Taken During Multiday Autosampler Experiment. ....	3-28
3	Summary of <i>Aphanizomenon flos-aquae</i> Cell Counts (cells/mL) in Samples Taken During Multiday Autosampler Experiment. ....	3-30

## CONTENTS

Section	Page
4	Chlorophyll- <i>a</i> Data from Upstream of Curtain and Below Iron Gate Dam ..... 3-32
5	Summary of Possible Range of Wedderburn Numbers for Iron Gate Reservoir Between July and September of 2015. .... 4-3
6	Summary of Possible Range of Richardson Number and Thermocline Tilt for Iron Gate Reservoir Between July and September. .... 4-4

### Figures

1	Iron Gate Reservoir Intake Tower, Trash Rack, and A-frame Debris Boom. .... 1-1
2	<i>Microcystis aeruginosa</i> Vertical Distribution in August 2008. .... 1-2
3	Plan View of Curtain Upstream of the Iron Gate Powerhouse Conduit Intake Near the Southeast Abutment of Iron Gate Dam. .... 2-1
4	Cross-section View of the Intake Barrier Curtain Upstream of the Iron Gate Powerhouse Conduit Intake Near the Southeast Abutment of Iron Gate Dam. .... 2-2
5	Project Vicinity, Sampling Locations, and Surrounding Landmarks. .... 3-2
6	Daily Average of Near-surface (0.1 to 1.3 m) BGA Concentration (RFU) Measured by Data Sondes Upstream and Downstream of the Curtain in Iron Gate Reservoir and in the Klamath River Below Iron Gate Dam (near the Hatchery Bridge) from June 15 to September 15, 2015. .... 3-4
7	Daily Average BGA Concentration (RFU) as Measured by PacifiCorp Data Sonde in the Klamath River Below Iron Gate Dam (near the Hatchery Bridge) from June 15 to September 15 During Years 2012, 2013, 2014, and 2015. .... 3-4
8	Daily Average of Near-surface (0.1 to 1.3 m) Water Temperatures Measured by Data Sondes Upstream and Downstream of the Curtain in Iron Gate Reservoir, and in the Klamath River Below Iron Gate Dam (near the Hatchery Bridge) from June 15 to September 30, 2015. .... 3-5
9	Daily Average Water Temperature as Measured by PacifiCorp Data Sonde in the Klamath River Below Iron Gate Dam (near the Hatchery Bridge) from June 15 to September 15 During Years 2012, 2013, 2014, and 2015. .... 3-6
10	Daily Average of Near-surface (0.1 to 1.3 m) Water Temperatures Measured by Data Sondes Upstream and Downstream of the Curtain in Iron Gate Reservoir, and in the Klamath River Below Iron Gate Dam (near the Hatchery Bridge) from June 15 to September 30, 2015. .... 3-6
11	Daily Average Dissolved Oxygen as Measured by PacifiCorp Data Sonde in the Klamath River Below Iron Gate Dam (near the Hatchery Bridge) from June 15 to September 15 During Years 2012, 2013, 2014, and 2015. .... 3-7
12	Nutrients and Chlorophyll- <i>a</i> Results Upstream and Downstream of the Curtain, and Below Iron Gate Dam, Taken Near the Surface (0.5 m). .... 3-9
13	<i>Aphanizomenon flos-aquae</i> , <i>Microcystis aeruginosa</i> , and Microcystin Results Upstream and Downstream of the Curtain, and Below Iron Gate Dam, Taken Near the Surface (0.5 m). .... 3-10
14	Comparison of Total Nitrogen (mg/L) Concentrations Below Iron Gate Dam from 2009 to 2015. .... 3-11
15	Comparison of Ammonia Nitrogen (mg/L) Concentrations Below Iron Gate Dam from 2009 to 2015. .... 3-11
16	Comparison of Nitrate Nitrogen (mg/L) Concentrations Below Iron Gate Dam from 2009 to 2015. .... 3-12
17	Comparison of Total Phosphorus (mg/L) Concentrations Below Iron Gate Dam from 2009 to 2015. .... 3-12

Section	Page
18	Comparison of Phosphate Phosphorus (mg/L) Concentrations Below Iron Gate Dam from 2009 to 2015..... 3-13
19	Nutrients and Chlorophyll- <i>a</i> Results Upstream and Downstream of the Curtain, and Below Iron Gate Dam, Taken at Depth (12.0 m)..... 3-14
20	<i>Aphanizomenon flos-aquae</i> , <i>Microcystis aeruginosa</i> , and Microcystin Results Upstream and Downstream of the Curtain at Depth (12.0 m), and Below Iron Gate Dam..... 3-15
21	Nutrients and Chlorophyll- <i>a</i> Integrated Sample (0-8 m) Results Upstream and Downstream of the Curtain, and Below Iron Gate Dam..... 3-16
22	<i>Aphanizomenon flos-aquae</i> , <i>Microcystis aeruginosa</i> , and Microcystin Integrated Sample (0-8 m) Results Upstream and Downstream of the Curtain, and Below Iron Gate Dam..... 3-17
23	Comparison of Microcystin Concentrations (µg/L) in Copco Reservoir at Cable Boom, Iron Gate Reservoir at Log Boom, and Below Iron Gate Dam in July, August, and September from 2010-2015..... 3-18
24	Comparison of <i>Microcystis aeruginosa</i> Density (cells/mL) in Copco Reservoir at Cable Boom, Iron Gate Reservoir at Log Boom, and Below Iron Gate Dam in July, August, and September from 2010-2015..... 3-19
25	Comparison of <i>Aphanizomenon flos-aquae</i> Cell Counts (cells/mL) in Copco Reservoir at Cable Boom, Iron Gate Reservoir at Log Boom, and Below Iron Gate Dam in July, August, and September from 2010-2015..... 3-20
26	Comparison of Microcystin Levels (µg/L) in Copco Reservoir from 2009-2015. (August 25, 2013, microcystin data were at 1,200 (µg/L).)..... 3-21
27	Comparison of Microcystin Levels (µg/L) in Iron Gate Reservoir from 2009-2015..... 3-21
28	Comparison of Microcystin Levels (µg/L) Below Iron Gate Dam from 2009-2015. .... 3-22
29	Total Microcystin at Link River Dam and the Klamath River Below Iron Gate Dam from 2009-2015 baseline water quality samples..... 3-22
30	TN and TP Above Copco Reservoir (near Shovel Creek) and Below Iron Gate Dam from 2009 to 2015..... 3-23
31	Autosampler Located Upstream of the Curtain in Iron Gate Reservoir. .... 3-25
32	Autosampler Located Adjacent to the Klamath River Downstream of Iron Gate Dam. .... 3-25
33	Microcystin Data from Samples Collected over a 96-hour Sampling Period Using Autosamplers Upstream of the Curtain and Below Iron Gate Dam. .... 3-26
34	<i>Microcystis aeruginosa</i> Cell Counts from Samples Collected over a 96-hour Sampling Period using Autosamplers Upstream of the Curtain and Below Iron Gate Dam. .... 3-28
35	<i>Aphanizomenon flos-aquae</i> Cell Counts from Samples Collected Over a 96-hour Sampling Period Using Autosamplers Upstream of the Curtain and Below Iron Gate Dam. .... 3-29
36	Chlorophyll- <i>a</i> data from Samples Collected Over a 96-hour Sampling Period Using Autosamplers Upstream of the Curtain in Iron Gate Reservoir and Below Iron Gate Dam in the Klamath River. .... 3-31
37	Photographs of Sequential Chlorophyll- <i>a</i> filters from the Autosampler Below Iron Gate Dam from August 31 to September 4, 2015. .... 3-33
38	Microcystin Data from Samples Collected at Six Depths Upstream and Downstream of the Curtain on 8/31/2015 (RL=reporting limit at 0.18 µg/L). .... 3-34
39	Comparison of <i>Microcystis aeruginosa</i> Cell Counts Upstream and Downstream of Curtain on 8/31/2015 (ND = nondetect)..... 3-35
40	Comparison of <i>Aphanizomenon flos-aquae</i> Cell Counts Upstream and Downstream of Curtain on 8/31/2015 (ND=nondetect)..... 3-35

## CONTENTS

Section	Page
41	Comparison of Chlorophyll- <i>a</i> vertical Profiles Upstream and Downstream of Curtain on 8/31/2015..... 3-36
42	Vertical Water Temperature Profiles Upstream and Downstream of the Curtain on /31/2015. 3-36
43	Vertical Dissolved Oxygen Profiles Upstream and Downstream of the Curtain on 8/31/2015.3-37
44	Vertical pH Profiles Upstream and Downstream of the Curtain on 8/31/2015..... 3-37
45	Photo and Schematic Overview of the Components of the RiverRay ADCP System. .... 3-38
46	Acoustic Doppler Current Profiler Field Deployment. .... 3-39
47	Acoustic Doppler Current Profiler Transect Measurement Along the Curtain in Iron Gate Reservoir in August 2015..... 3-39
48	Schematic Showing the Approximate Locations of ADCP Transects Relative to the Curtain, Buoys, and the BOB..... 3-40
49	Representative Contour Map of the Magnitude of Current Velocities in the North-South Direction at Transect Location 1..... 3-41
50	Representative Contour Map of the Magnitude of Current Velocities in the North-South Direction at Transect Location 2..... 3-41
51	Representative Contour Map of the Magnitude of Current Velocities in the North-South Direction at Transect Location 3..... 3-42
52	Velocity Profiles at Transect Locations 1, 2 and 3, Taken from the Center of the Three Transects Upstream of the Curtain..... 3-42
53	Representative Contour Maps of the Magnitude of Current Velocities in the North-South Direction at Transect Location 4 (top) and 5 (bottom)..... 3-43
54	Vertical Profiles of Water Temperature at 15 Locations Downstream of the Barrier Curtain on 8/31/2015..... 3-44
55	Vertical Profiles of Dissolved Oxygen at 15 Locations Downstream of the Barrier Curtain on 8/31/2015..... 3-45
56	Vertical Profiles of pH at 15 Locations Downstream of the Barrier Curtain on 8/31/2015..... 3-45
57	Vertical Profiles of Chlorophyll- <i>a</i> at 15 Locations Downstream of the Barrier Curtain on 8/31/2015..... 3-46
58	Vertical Temperature Profile Data at Iron Gate Reservoir Log Boom in 2010, 2011, and 2013..... 4-2
59	Wind Speed Data Collected from 6/15/2015 to 11/13/2015..... 4-2
60	Conceptual Profile View of Thermal Conditions in Iron Gate Reservoir Showing the Location of the BOBs, Curtain, and Intake Tower..... 5-2

## ACRONYMS AND ABBREVIATIONS

ADCP	Acoustic Doppler Current Profiler
<i>Aphanizomenon</i>	<i>Aphanizomenon flos-aquae</i>
avg	average
BGA	blue-green algae
BOB	Basic Observation Buoy
°C	degrees Celsius
ft	foot/feet
ft/s	foot/feet per second
HDPE	high-density polyethylene
hr	hour
IM	interim measure
in.	inch
kg/m <sup>3</sup>	kilogram(s) per cubic meter
KHSA	Klamath Hydroelectric Settlement Agreement
lb	pound(s)
µg/L	microgram(s) per liter
m	meter(s)
m/s	meter(s) per second
m/s <sup>2</sup>	meter(s) per second squared
mg/L	milligram(s) per liter
<i>Microcystis</i>	<i>Microcystis aeruginosa</i>
mL	milliliter
n/a	not applicable
NH <sub>3</sub> -N	ammonia
NO <sub>2</sub>	nitrite
NO <sub>3</sub>	nitrate
PO <sub>4</sub>	orthophosphate
RFU	Relative Fluorescence Unit
TN	total nitrogen
TP	total phosphorus
USGS	U.S. Geological Survey





## EXECUTIVE SUMMARY

An intake barrier curtain was installed in Iron Gate reservoir in 2015 following the test of a prototype curtain in 2014. The curtain was intended to segregate reservoir surface waters with higher blue-green algae concentrations and prevent those waters from being entrained into the Iron Gate powerhouse intake and released to the Klamath River downstream of Iron Gate dam. Isolation of the surface waters should reduce the amount of blue-green algae released from Iron Gate reservoir into the Klamath River and improve water quality conditions downstream.

Detailed investigations of the effects of the intake barrier curtain resulted in the following conclusions:

- Installation of the curtain resulted in the withdrawal of deeper waters from Iron Gate reservoir. Velocity measurements indicated that shallow, near-surface water upstream of the curtain essentially stopped moving toward the powerhouse intake. Water velocities approaching the curtain were highest near the bottom of the curtain and a flow envelope formed below the photic zone in Iron Gate reservoir upstream of the curtain.
- Water temperatures and blue-green algae concentrations were reduced downstream of the curtain and in the Klamath River downstream of the dam following curtain deployment; they were also similar to deeper waters upstream of the curtain. Water temperatures in the Klamath River downstream of Iron Gate dam in 2015 were cooler than in previous years, despite ambient temperatures that were warmer than recent years.
- Dissolved oxygen levels downstream of the curtain reflected dissolved oxygen levels from deeper-water upstream of the curtain. Dissolved oxygen levels in powerhouse releases remained within established water quality criteria because of turbine venting at the Iron Gate powerhouse, which was previously initiated on an ongoing basis in 2010.
- Monitoring conducted in late summer 2015 indicated reductions in microcystin (70 percent), *Microcystis aeruginosa* (82 percent), *Aphanizomenon flos-aquae* (97 percent), and chlorophyll-*a* (61 percent) occurred downstream of Iron Gate dam when compared to surface samples collected at a depth of 0.5 meter upstream of the barrier curtain.
- Overall, there do not appear to be large areas (dead zones) where water is not mixing or moving through the area downstream of the curtain, which reduces the potential for blue-green algae to proliferate downstream of the curtain.
- Under typical conditions, winds recorded at Iron Gate reservoir are unlikely to mix the epilimnion or create internal thermocline tilt such that epilimnetic waters would be drawn under the curtain.

Overall, the studies conducted in 2015 indicate that the curtain was effective at isolating near-surface waters of Iron Gate reservoir upstream of the curtain. Water quality samples, physical measurements, velocity profiles, and field observations of conditions consistently identified that waters of the photic zone, where the majority of blue-green algae occur, were largely isolated to the upstream side of the curtain. Water that ultimately passed under the curtain was drawn from deeper, cooler depths in regions of Iron Gate reservoir upstream of the curtain.



## 1 INTRODUCTION

The Klamath Hydroelectric Settlement Agreement (KHSA) includes Interim Measure 11 (Interim Water Quality Improvements), which is intended to address water quality improvement in the Klamath River during the interim period leading up to potential dam removal. Activity 5 of PacifiCorp’s 2015 Interim Measure (IM) 11 Study Plan is “Continued Evaluation of Intake Barrier Systems for Water Quality Improvement from Iron Gate Powerhouse Releases.” The purpose of Activity 5 is to continue to evaluate selective withdrawal or algae exclusion systems at the powerhouse intake in Iron Gate reservoir to improve the quality of water that the Iron Gate powerhouse releases to the Klamath River. The Activity 5 evaluation will develop information to assist in the potential design and implementation of intake barrier or algae exclusion systems to improve water quality conditions and reduce blue-green algae (BGA) levels in the Klamath River during the interim period prior to planned dam removal.

Blooms of *Microcystis aeruginosa* (*Microcystis*) cyanobacteria, a BGA, occur in Iron Gate and Copco reservoirs as well as upstream of those reservoirs at Upper Klamath Lake. *Microcystis* is of concern because it can produce the toxin microcystin. The presence of microcystin can result in recommendations to the public to avoid contact with affected waters in the reservoirs, and, at times, the Klamath River downstream. Because the intake for the Iron Gate powerhouse is only about 35 feet deep and withdraws water from its invert depth up to the reservoir, surface water is withdrawn from the photic zone and released downstream into the upper Klamath River. When BGA are blooming in Iron Gate reservoir, they are concentrated in the surface waters where favorable light conditions in the photic zone aid their growth. Because surface waters are pulled into the Iron Gate powerhouse intake the BGA can easily be entrained and discharged into the Klamath River (Figure 1). Earlier studies at Copco and Iron Gate reservoirs have demonstrated that *Microcystis* is more prevalent in near-surface waters than at depth (Moisander 2008), as shown in Figure 2.



Figure 1. Iron Gate Reservoir Intake Tower, Trash Rack, and A-frame Debris Boom.

(Photo Date: September 10, 2008.)

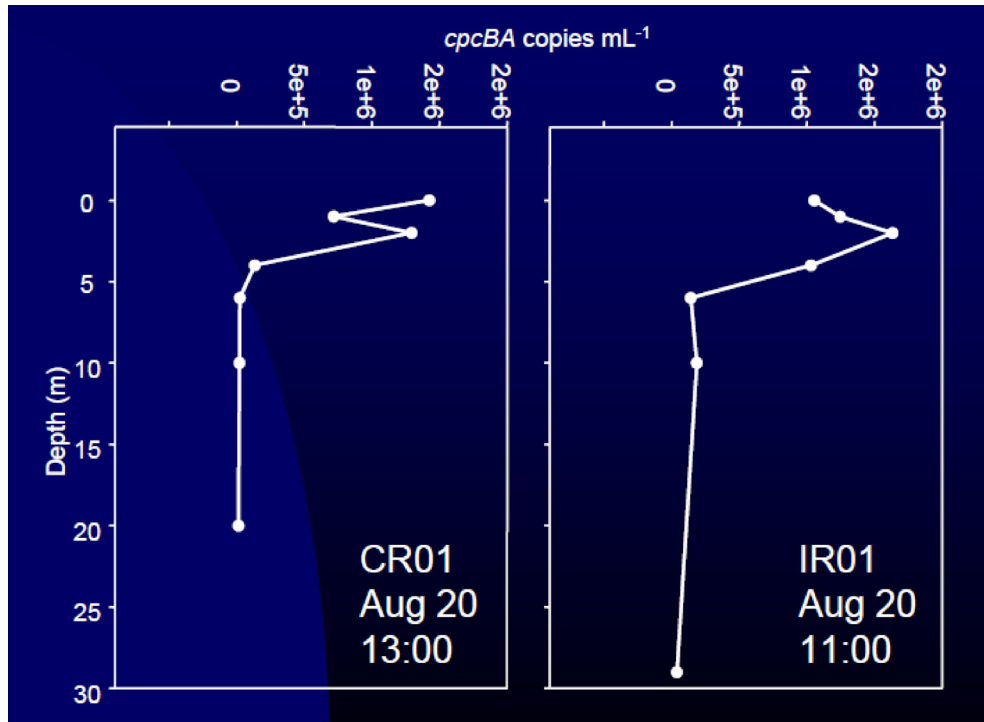

Figure 2: *Microcystis aeruginosa* Vertical Distribution in August 2008.

Source: Moisander 2008.

In the summer of 2015, PacifiCorp installed an intake barrier curtain (hereafter referred to as “curtain”) upstream of the Iron Gate powerhouse conduit intake tower with the objective to reduce algal biomass entrainment into the intake tower and subsequently decrease algal biomass (and potential associated algal toxins) released from the Iron Gate powerhouse. The intent of the curtain is to create a preferential flow path to the reservoir intake from below the reservoir’s surface photic zone, and in so doing reduce the amount of algae (largely residing in the photic zone) that is entrained into the intake and subsequently released from the Iron Gate powerhouse. Although not an explicit objective, a secondary potential benefit of the curtain is to facilitate movement of cool water from the lower depths of the reservoir toward the powerhouse conduit intake, which will increase the proportion of cooler water that is entrained into the intake and subsequently released downstream.

## 2 DESCRIPTION OF INTAKE BARRIER CURTAIN

The curtain is located across the southwest corner of Iron Gate reservoir just to the northeast of the existing powerhouse conduit intake tower (Figure 3). The curtain consists of impermeable coated nylon fabric (Seaman Corporation type 3024 XR-5B) that is 1.5 pounds (lb) per square yard in weight. The curtain spans a horizontal length of about 800 feet (ft) and consists of panels cut to fit the reservoir profile to a maximum depth of 35 ft (Figure 3). The top edge of the curtain is strengthened to allow clamping to a surface float system and the lower edge is weighted by a chain (approximately 4.8 lb per ft). The chain is shrouded to protect against snagging.



Figure 3. Plan View of Curtain Upstream of the Iron Gate Powerhouse Conduit Intake Near the Southeast Abutment of Iron Gate Dam.

(Photo Credit: Google Earth, 8/26/2013.)

The curtain is held in a vertical position in the water column by a supporting net system. The net system consists of braided polyester cord, with knotted construction comprising a 6-inch (in.) by 6-in.-square mesh with an 85-ft maximum depth. As with the curtain, the netting panels were manufactured to fit the bottom contours of the reservoir profile at the deployment alignment. The tops of the netting panels are attached to the same floatation system as the curtain and the bottom edges of the net panels are also weighted by a chain (approximately 4.8 lb per ft) to hold the net in place on the reservoir bottom. The netting chain is shrouded in protective cover to protect against snagging. An additional weighted chain just beneath the curtain fabric allows the net to hold the curtain in a vertical position at lower pool elevations.

The curtain and supporting net system are of sufficient construction and flexibility to function over a total reservoir water surface elevation fluctuation of 16 ft (from 2,330 ft to 2,314 ft), reflecting recent reservoir operating levels. The impermeable curtain sections are adjustable and can be furled to within a minimum of 5 ft from the water surface for maintenance, seasonal storage, or for other reasons.

## 2 Description of Intake Barrier Curtain

The surface float system (holding the top edge of the curtain) consists of 18-in.-diameter and 25-ft-long, high-density polyethylene (HDPE), foam-filled pipe sections that provide sufficient buoyancy to maintain the top of the float at a minimum of 12 in. above the water surface at all times. The connection between the floats, netting, and fabric panels is as impermeable as practical. These connections consist of a clamping plate attached to the underside of the floats with the netting and fabric panels inserted between the clamping plate and a welded HDPE plate.

Anchors are located along the length of the curtain and have sufficient capacity to hold the curtain and net system in place. Ten Danforth-type anchors are used to provide the curtain with lateral stability to maintain its position and resist wind-driven loading and reservoir currents. Steel crown floats are located approximately 50 ft from the curtain to separate vertical anchor load forces from the curtain system. Shoreline anchors are located at the upstream dam face and at the northeast shoreline.

Figure 4 is a cross-section view of the curtain upstream of the Iron Gate powerhouse conduit intake near the southeast abutment of the Iron Gate dam.

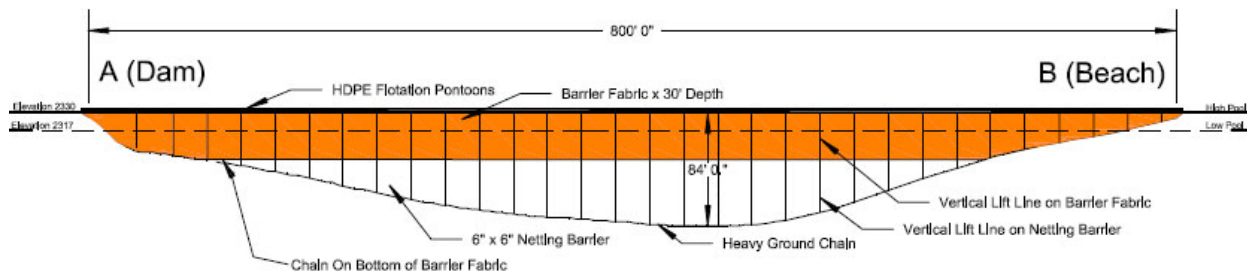

Figure 4. Cross-section View of the Intake Barrier Curtain Upstream of the Iron Gate Powerhouse Conduit Intake Near the Southeast Abutment of Iron Gate Dam.

Installation of the curtain was completed on June 26, 2015, and it was operationally tested over the next few days (to July 1). Subsequently, the curtain was unfurled incrementally on the following dates to specific depths as follows:

1. July 10 curtain unfurling to 10-ft depth
2. July 16 curtain unfurling to 15-ft depth
3. July 27 curtain unfurling to 20-ft depth
4. July 31 curtain unfurling to 25-ft depth
5. August 17 curtain unfurling to 30-ft depth
6. August 27 curtain unfurling to 35-ft depth

These incremental unfurling steps allowed for testing of performance at various depths and assessment of impacts to downstream dissolved oxygen concentrations as the curtain was lowered. The curtain was furled to its minimum depth of 5 ft on November 13, 2015.

### 3 STUDY ACTIVITIES

Several study activities were completed to monitor the effectiveness of the curtain system at reducing algal biomass entrainment and subsequent release to the Klamath River. The following activities were completed:

- Data sonde deployment. Continuously-recording data sondes collected data on water temperature, dissolved oxygen, pH, conductivity, and phycocyanin in Iron Gate reservoir on the upstream and downstream sides of the curtain and in the Klamath River below Iron Gate dam (near the Hatchery Bridge). Downstream sonde monitoring is routine and occurred throughout the year. Monitoring in the reservoir upstream and downstream of the curtain began about 2 weeks before curtain deployment and continued about until about 2 weeks after the curtain was furled.
- Bimonthly grab sampling. Twice-monthly vertical grab samples were collected from the water column upstream and downstream of the curtain. Sampling occurred during approximately the same period as reservoir sonde deployment. Conditions downstream of Iron Gate dam were assessed through water quality monitoring conducted as part of the KHS A IM 15 baseline water quality monitoring program.
  - Short-term, multiday sampling. More intensive and shorter-duration sampling was conducted as part of specific study efforts to evaluate curtain effectiveness. Figure 5 shows the sampling locations. The sampling efforts included the following actions:
    - Deploy autosamplers in Iron Gate reservoir upstream of the curtain and in the river downstream of Iron Gate dam.
    - Measure current velocity upstream and downstream of the curtain.
    - Conduct vertical profiling of the water column upstream and downstream of the curtain to assess differences in nutrients, microcystin, algae species, chlorophyll-*a*, and physical water quality, including water temperature, dissolved oxygen, and pH.
    - Use an Acoustic Doppler Current Profiler (ADCP) to monitor water column velocities along both sides of the curtain. The objective of the ADCP study was to measure water velocity and direction as it approached the curtain and conditions downstream of the curtain. These data were intended to identify whether the curtain effectively segregated surface waters upstream of the curtain.
    - Conduct vertical profiling of physical parameters at various locations downstream of the curtain.

PacifiCorp conducted routine monitoring of hydrology during the study period, including powerhouse flows, spills, reservoir stage, and downstream river flows (U.S. Geological Survey [USGS] gage). PacifiCorp also collected meteorology data, including air temperature, wind speed and direction, and other parameters from a station on Iron Gate dam.

The objectives, methodology, and findings of these study activities are presented in this section. Measurements associated with the physical curtain dimensions are presented in English units to maintain consistency with the curtain design information. Other measurements are presented in units typically used in scientific investigations in the Klamath Basin; for example, flow in cubic feet per second, and concentrations in milligrams per liter (mg/L).

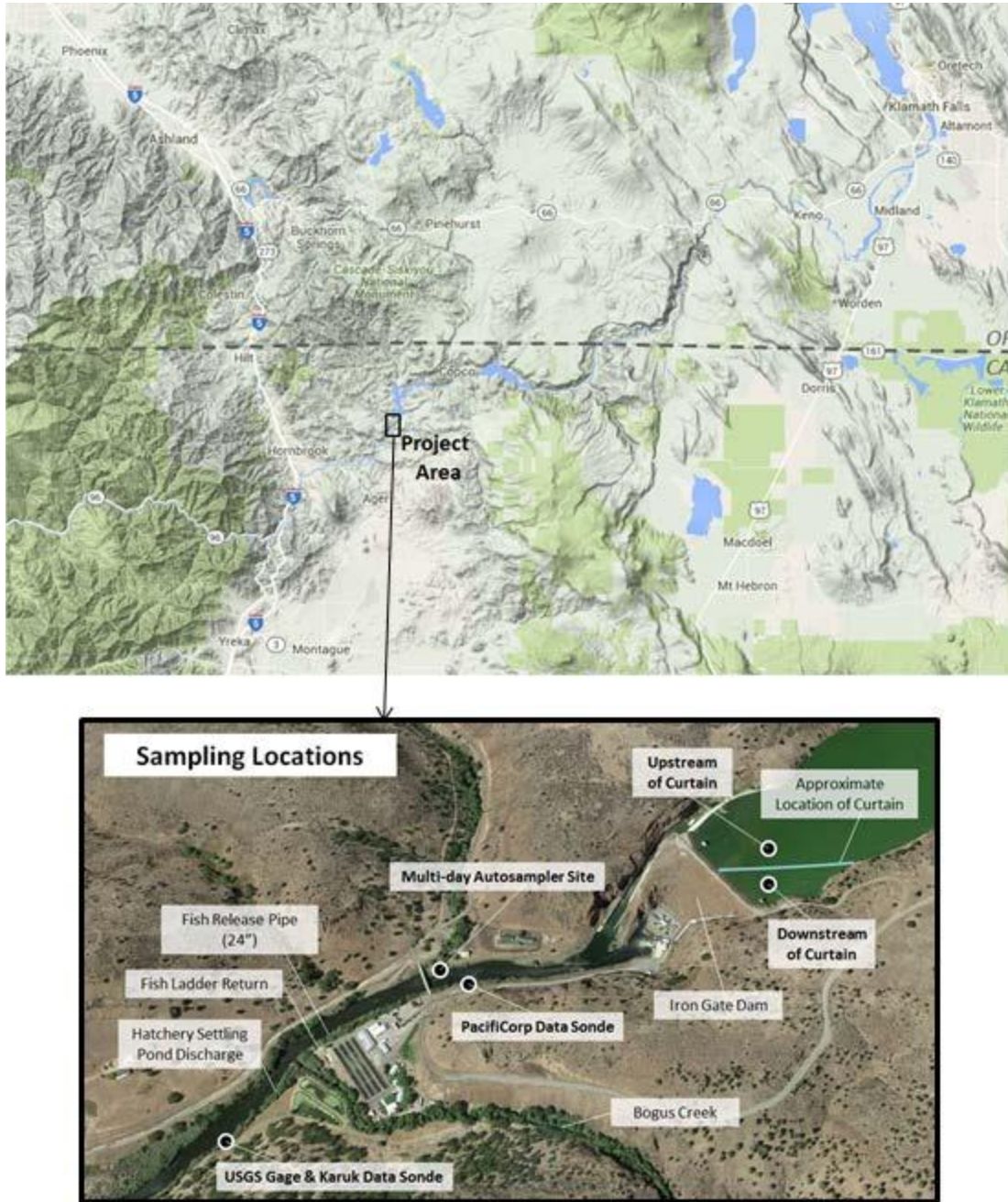

Figure 5. Project Vicinity, Sampling Locations, and Surrounding Landmarks.

### 3.1 DATA SONDE DEPLOYMENT

The effectiveness of the curtain in isolating surface waters and reducing algae concentrations released to the Klamath River was assessed in part using continuous data sonde monitoring upstream and downstream of the curtain and in the river downstream of Iron Gate dam. Continuous recording data sondes at the reservoir locations were used to assess and compare vertical water quality profile conditions upstream and downstream of the curtain. The continuous recording data sonde in the river below Iron Gate dam was used to assess and compare conditions in the river below Iron Gate dam (before, during, and after curtain deployment) and in conjunction with the concurrent reservoir vertical profiles.



The objective of obtaining continuous vertical profiles in the reservoir was to characterize near-surface waters and deeper waters as well as to determine the approximate extent of the photic zone both upstream and downstream of the barrier for the duration of its deployment. Near-surface waters define a zone where maximum primary production typically occurs (i.e., the photic zone). The deeper waters below the photic zone and beneath the bottom of the curtain were hypothesized to be preferentially drawn into the intake following curtain deployment. The continuous vertical profiling allowed identification of the curtain depth where near-surface waters are effectively segregated from deeper waters. The data from sondes deployed upstream and downstream of the barrier were also compared to the sonde data from downstream of Iron Gate dam to evaluate changes in water quality as waters moved past the curtain, out of Iron Gate reservoir, and into the Klamath River downstream.

### 3.1.1 Methodology

PacifiCorp deployed two YSI-EXO2 multiparameter sondes attached to a Basic Observation Buoy (BOB)<sup>1</sup> mechanical profiler to measure physical water quality parameters and phycocyanin just upstream and downstream of the curtain (Figure 5). The BOB mechanical profilers were programmed to lower the sondes to fixed depths at fixed time intervals for collection of information over a vertical profile depth of approximately 25 meters (m). Each BOB was mounted on a platform measuring 1.2 m by 1.2 m (4 ft by 4 ft) with eye bolts on the side to connect anchors. The platforms contained a solar cell, backup battery, and a covered mechanical system that controlled the raising and lowering of the sonde (attached to a cable and safety line) at specified time and depth intervals.

The data sondes collected water temperature, dissolved oxygen, pH, conductivity, and phycocyanin data continuously during deployment. The phycocyanin fluorescence probe was used as a surrogate for continuous monitoring of BGA and provided measurements of BGA abundance (or concentrations) in Relative Fluorescence Units (RFUs). These probes do not measure specific BGA species or cell counts; however, they did provide a continuous record of BGA abundance. BGA species or cell counts were instead identified in the grab sampling monitoring (as discussed in Section 3.2).

Data from the two BOB data sondes in the reservoir were compared with data from a YSI-EXO2 multiparameter sonde deployed downstream of Iron Gate dam to evaluate the effect of the curtain on water quality released to the Klamath River. Data from the two BOB data sondes were averaged over the range from approximately 0.1 to 1.3 m (0.3 to 4.3 ft) of depth to represent near-surface waters in the reservoir. While the BOBs were visited weekly, there were instances when the winch mechanism was fouled by filamentous algae accumulation and the sonde remained fixed at a single depth for extended periods. The averaging also avoided data gaps when the sondes did not complete full depth profiling. These near-surface waters are also represented in the grab sampling and autosampler efforts that targeted the photic zone.

### 3.1.2 Results

Results from the continuous data sonde monitoring upstream and downstream of the curtain and in the river below Iron Gate dam are discussed below.

#### 3.1.2.1 Blue-Green Algae

The continuous data collected by the sondes were useful in assessing conditions “before” and “after” curtain deployment, as well as the evolution of conditions as the curtain was unfurled over several weeks. Data from the data sondes indicated that initial BGA growth started at low levels in July. Seasonal peak

---

<sup>1</sup> The Basic Observation Buoy is a floating platform that carries vertically-movable data sondes with sensors to measure in situ water temperature, DO, pH, specific conductance, and phycocyanin.

bloom conditions appear to have occurred in mid-August and continued through October (Figure 6). BGA concentrations were substantially less downstream of the curtain in the vicinity of the intake than in the reservoir upstream of the curtain. Comparing sonde data upstream of the barrier, downstream of the barrier, and in the Klamath River downstream of the dam indicate that BGA concentrations generally decreased from upstream to downstream.

Comparison of BGA data from below Iron Gate dam for the years 2012-2015 shows that deployment of the curtain in 2015, particularly after the curtain reached 30 feet in depth, corresponded with notably reduced BGA concentrations in the Klamath River downstream of Iron Gate dam relative to conditions in prior years (Figure 7). This indicates that the curtain had a beneficial effect on reducing algae entrainment into the intake and corresponding BGA concentrations downstream from the powerhouse.

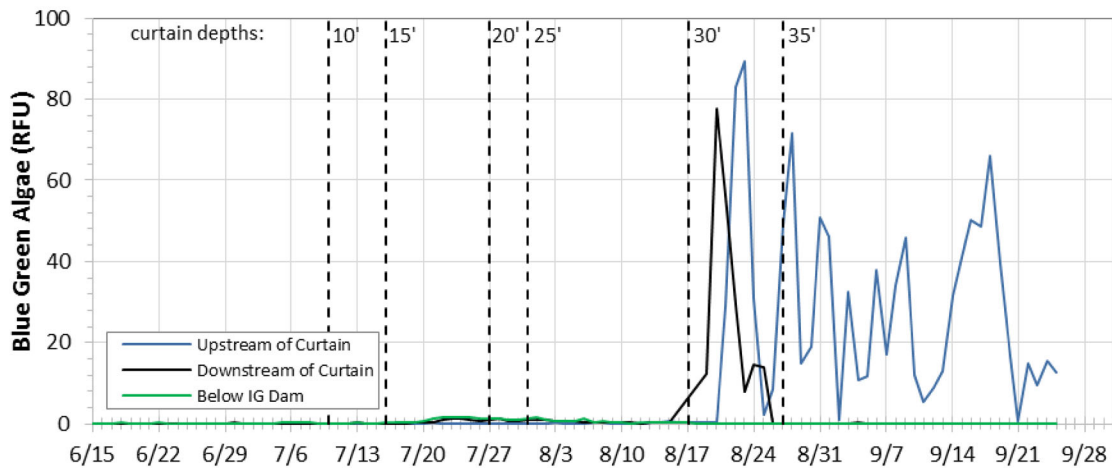

Figure 6. Daily Average of Near-surface (0.1 to 1.3 m) BGA Concentration (RFU) Measured by Data Sondes Upstream and Downstream of the Curtain in Iron Gate Reservoir and in the Klamath River Below Iron Gate Dam (near the Hatchery Bridge) from June 15 to September 15, 2015.

Note: Vertical hatched lines indicate dates during 2015 when the curtain was lowered to specified depths.

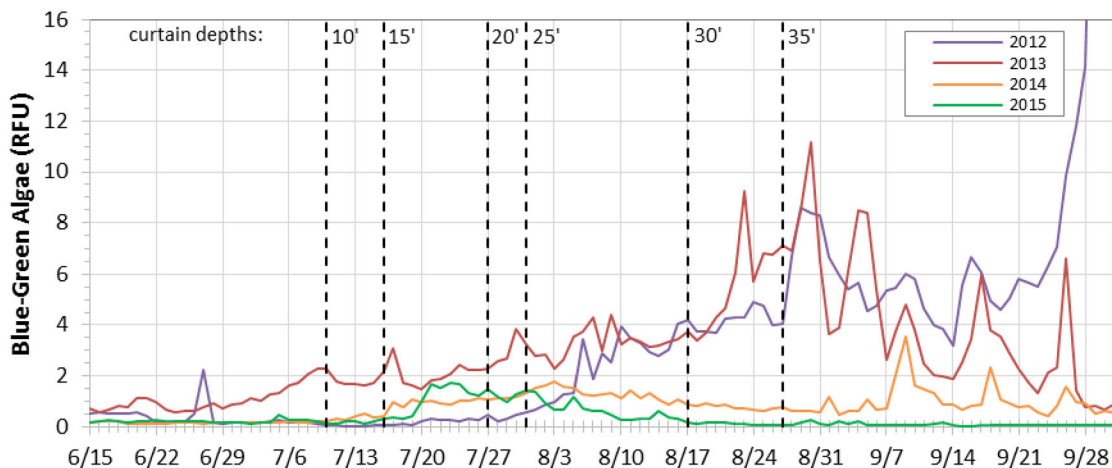

Figure 7. Daily Average BGA Concentration (RFU) as Measured by PacifiCorp Data Sonde in the Klamath River Below Iron Gate Dam (near the Hatchery Bridge) from June 15 to September 15 During Years 2012, 2013, 2014, and 2015.

Note: Vertical hatched lines indicate dates during 2015 when the curtain was lowered to specified depths. Vertical hatched lines are not shown for the curtain deployment in 2014 (which was initiated on August 12, 2014, unfurled to a maximum depth of 35 feet on August 28, 2014, and subsequently removed on September 8, 2014).

### 3.1.2.2 Water Temperature

Following curtain deployment, water temperatures upstream and downstream of the curtain generally diverged while temperatures downstream of the curtain and below Iron Gate dam generally converged (Figure 8). Prior to curtain deployment, downstream water temperatures were cooler than in near surface (average of top 0.1 to 1.3 m [0.3 to 4.3 ft] of depth) reservoir water upstream of the dam. This is because, without the curtain, downstream river temperatures reflect the range of water temperatures from the surface to near 10 m (32.8 ft) – the depth of the powerhouse intake.

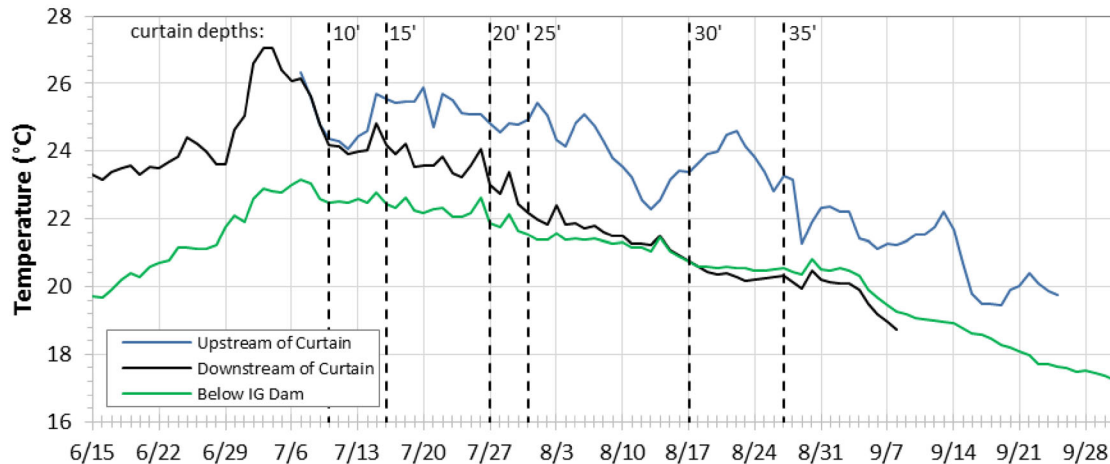

Figure 8. Daily Average of Near-surface (0.1 to 1.3 m) Water Temperatures Measured by Data Sondes Upstream and Downstream of the Curtain in Iron Gate Reservoir, and in the Klamath River Below Iron Gate Dam (near the Hatchery Bridge) from June 15 to September 30, 2015.

Note: Vertical hatched lines indicate dates during 2015 when the curtain was lowered to specified depths.

When the curtain deployment depth reached approximately 4.6 to 6.1 m (15 to 20 ft), water temperatures upstream and downstream of the curtain began to diverge, with downstream temperatures remaining approximately 2 degrees Celsius (°C) cooler than upstream temperatures into September. Waters downstream of the curtain were representative of deeper reservoir waters and thus deviated from the upstream curtain site. Throughout this same period, water temperatures downstream of the curtain and those in the Klamath River below the dam were similar.

A comparison of 2012-2015 water temperature below Iron Gate dam suggests that water temperatures following curtain deployment were up to 1.5°C cooler relative to prior years (Figure 9). This suggests that the curtain also had a beneficial effect of allowing selective withdrawal of cooler water from Iron Gate reservoir. The period of curtain deployment in 2015 coincided with the time of year when water temperatures typically reach their annual peak (Figure 9). However, in 2015, water temperatures downstream of Iron Gate dam peaked in early July before the curtain was deployed and then declined through the summer.

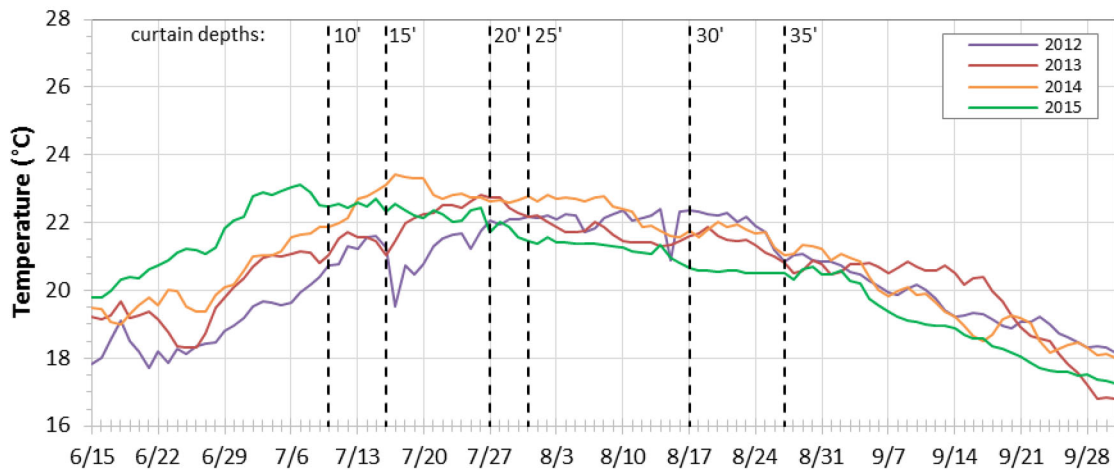

Figure 9. Daily Average Water Temperature as Measured by PacifiCorp Data Sonde in the Klamath River Below Iron Gate Dam (near the Hatchery Bridge) from June 15 to September 15 During Years 2012, 2013, 2014, and 2015.

Note: Vertical hatched lines indicate dates during 2015 when the curtain was lowered to specified depths. Vertical hatched lines are not shown for the curtain deployment in 2014 (which was initiated on August 12, 2014, unfurled to a maximum depth of 35 ft on August 28, 2014, and subsequently removed on September 8, 2014).

### 3.1.2.3 Dissolved Oxygen

Dissolved oxygen concentrations upstream and downstream of the curtain diverged under curtain deployment (Figure 10). Upstream of the curtain, there was higher dissolved oxygen (approximately 7-9 mg/L) as a result of primary production in near-surface waters. Downstream of the curtain, waters from depth had lower dissolved oxygen concentrations (approximately 4 to 6 mg/L). Dissolved oxygen concentrations were higher in the Klamath River (typically 7 to 8 mg/L) below Iron Gate dam because of reaeration through the powerhouse (Figure 10). A comparison of 2012-2015 dissolved oxygen concentrations below Iron Gate dam suggests that dissolved oxygen levels following curtain deployment were comparable to prior years (Figure 11).

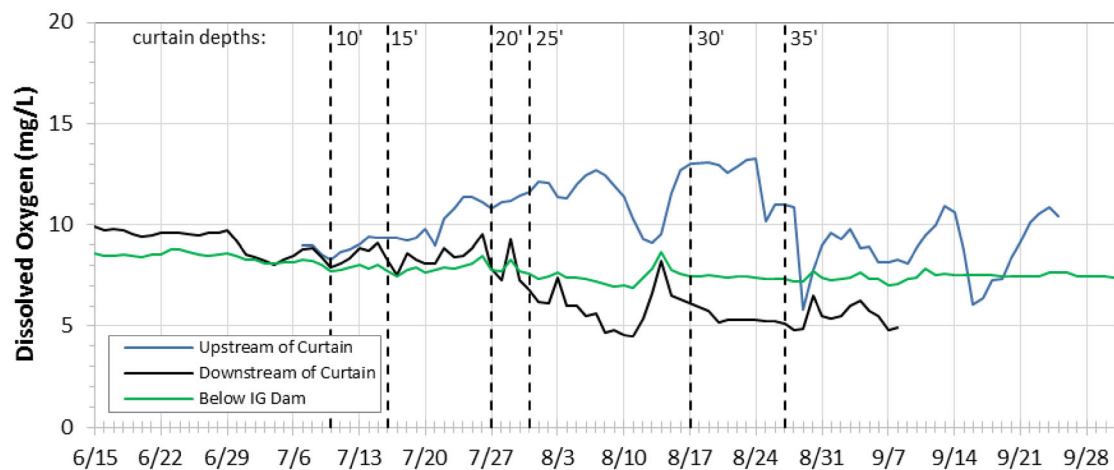

Figure 10. Daily Average of Near-surface (0.1 to 1.3 m) Water Temperatures Measured by Data Sondes Upstream and Downstream of the Curtain in Iron Gate Reservoir, and in the Klamath River Below Iron Gate Dam (near the Hatchery Bridge) from June 15 to September 30, 2015.

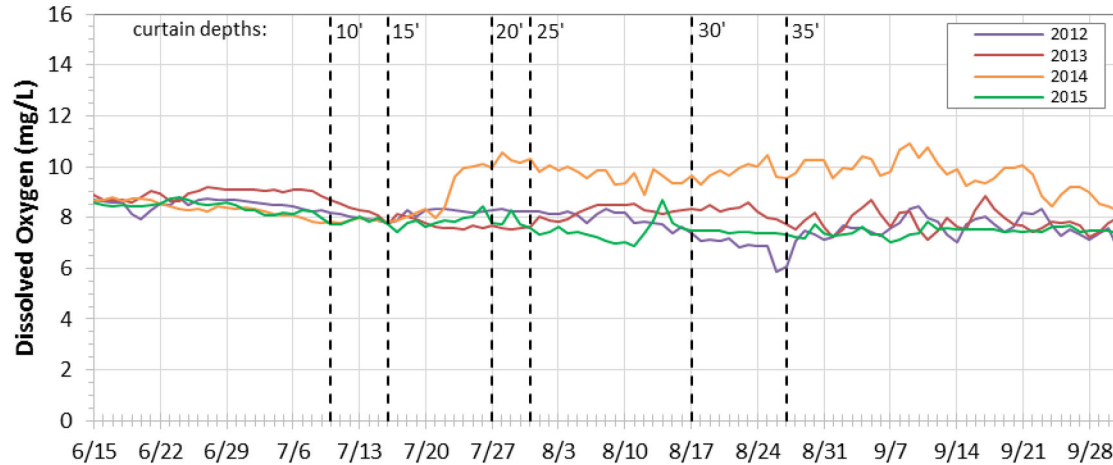

Figure 11. Daily Average Dissolved Oxygen as Measured by PacifiCorp Data Sonde in the Klamath River Below Iron Gate Dam (near the Hatchery Bridge) from June 15 to September 15 During Years 2012, 2013, 2014, and 2015.

Note: Vertical hatched lines indicate dates during 2015 when the curtain was lowered to specified depths. Vertical hatched lines are not shown for the curtain deployment in 2014 (which was initiated on August 12, 2014, unfurled to a maximum depth of 35 feet on August 28, 2014, and subsequently removed on September 8, 2014).

### 3.1.3 Summary

BGA, water temperature, and dissolved oxygen data from the data sondes located upstream and downstream of the curtain (near surface) and downstream of Iron Gate dam indicated that the curtain resulted in the withdrawal of deeper waters from Iron Gate reservoir. BGA concentrations (as RFU) were reduced downstream of the curtain and in the Klamath River downstream of the dam, water temperatures followed a similar trend, and dissolved oxygen also reflected a deeper withdrawal of water with lower dissolved oxygen. Although effects of the curtain were evident at relatively shallow depths (3 to 4.5 m [10 to 15 ft]), curtain performance at full depth (9 to 10.7 m [30 to 35 ft]) provided the greatest effect.

## 3.2 BIMONTHLY GRAB SAMPLING

Vertical grab samples at two depths and an integrated sample were used to characterize nutrient, microcystin, algae species, and other conditions in the near-surface upstream and downstream of the curtain and downstream of Iron Gate dam. The objective of this study element was to characterize near-surface waters where the majority of primary production occurs in the reservoir and augment the data from the long-term data sonde sampling program (Section 3.1).

### 3.2.1 Methodology

Grab samples at two depths (0.5 m and 12 m [1.6 ft and 39.4 ft]) and an integrated vertical grab sample (0 m to 8 m [0 ft to 26.1 ft]) were used to characterize conditions upstream and downstream of the curtain and downstream of Iron Gate dam. Grab samples were collected from June to October. Sampling locations included (1) upstream of the curtain, (2) downstream of the curtain, and (3) downstream of Iron Gate dam.

Samples were analyzed for nutrients and chlorophyll-*a* by the CH2M Laboratory, algae speciation by Aquatic Analysts, and microcystin by the U.S. Environmental Protection Agency Region 9 Laboratory. Nutrient conditions addressed herein include total nitrogen (TN), ammonia (NH<sub>3</sub>-N), nitrate+nitrite (NO<sub>3</sub>+NO<sub>2</sub>), total phosphorus (TP), and orthophosphate (PO<sub>4</sub>).

#### 3.2.2 Results

##### 3.2.2.1 Surface Samples

Surface samples collected at 0.5 m (1.6 ft) represented near-surface waters in the photic zone both upstream and downstream of the curtain as well as in the Klamath River downstream of Iron Gate dam.

In general, TN, NH<sub>3</sub>, and NO<sub>3</sub>+NO<sub>2</sub> concentrations all showed a seasonal trend of increasing through the summer and into fall period for all locations, but at varying degrees (Figure 12). Before the curtain was deployed to its maximum depth of 10.7 m (35 ft), differences in concentrations upstream of the curtain, downstream of the curtain and below Iron Gate dam were relatively modest. When the curtain was deployed to depths of 7.6 m (25 ft) or more, TN, NH<sub>3</sub>, and NO<sub>3</sub>+NO<sub>2</sub> concentrations in the surface samples were consistently higher downstream of the curtain and below the dam. These higher concentrations are likely a result of the following factors:

1. Contribution of inorganic nitrogen (NH<sub>3</sub> and NO<sub>3</sub>+NO<sub>2</sub>) from deeper waters that were drawn under the curtain and then manifest in the 0.5 m (1.6 ft) sample downstream of the curtain and the dam
2. More nutrient uptake and hence lesser concentrations because of higher rates of primary production in the surface waters upstream of the curtain

A notable spike in NO<sub>3</sub>+NO<sub>2</sub> concentration occurred in the river sample (below Iron Gate dam) in early September. The reason for this spike is not specifically known, but occurred during variable flow releases from Iron Gate dam<sup>2</sup>, which commenced on the first of September.

TP and PO<sub>4</sub> concentrations did not illustrate a similar seasonally increasing trend as the nitrogen constituents did (Figure 12). However, as with the nitrogen constituents, TP and PO<sub>4</sub> concentrations were generally higher downstream of the curtain and below the dam, particularly from about late July to mid-September. At that time, PO<sub>4</sub> upstream of the curtain at 0.5 m (1.6 ft) showed a clear seasonal depression, most likely in response to high primary production in near-surface waters. This same trend also is reflected in the chlorophyll-*a* data. After the curtain was deployed to 35 feet, chlorophyll-*a* samples downstream of the curtain and dam were near zero, while levels remained above approximately 10 micrograms per liter (µg/L) upstream of the curtain (Figure 12). These elevated chlorophyll-*a* concentrations upstream may include species other than *Aphanizomenon* and *Microcystis*. For example, there was a large *Gloeotrichia* bloom during certain periods of the summer, as well as other species (e.g., diatoms, greens) that were present upstream of the curtain.

---

<sup>2</sup> PacifiCorp provides variable flow releases to benefit anadromous fish habitat conditions in the Klamath River downstream of Iron Gate dam.

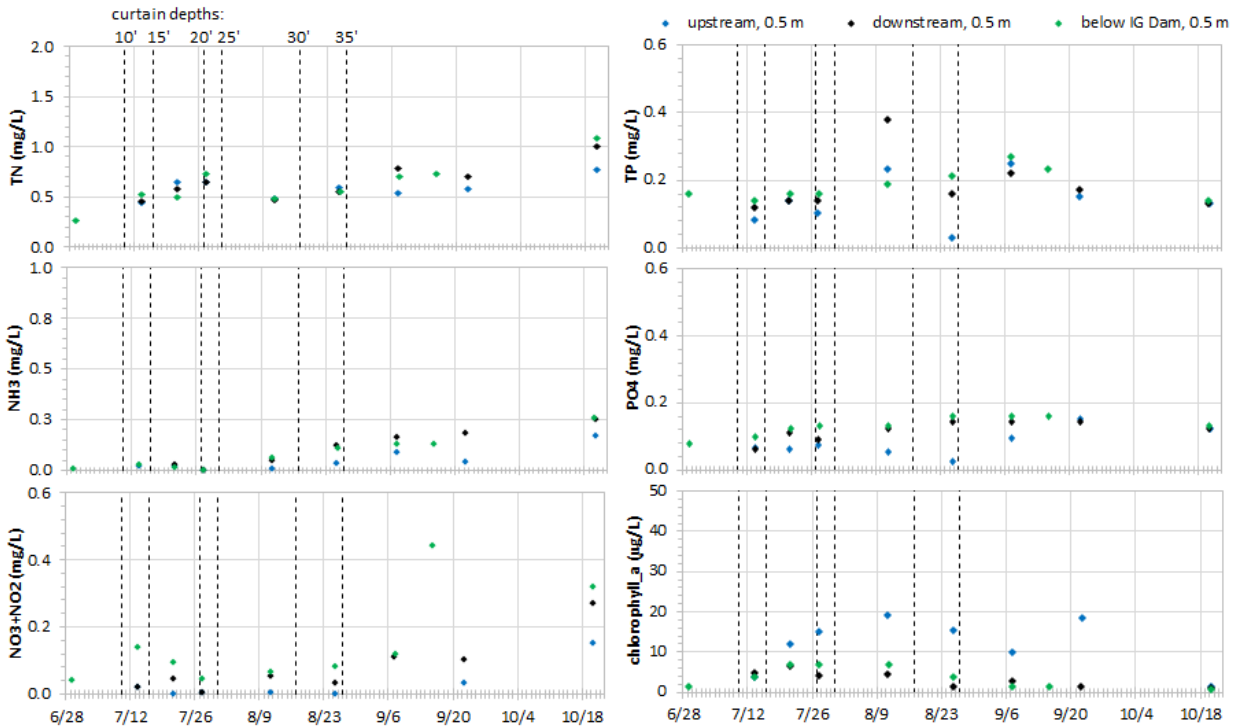

Figure 12. Nutrients and Chlorophyll-*a* Results Upstream and Downstream of the Curtain, and Below Iron Gate Dam, Taken Near the Surface (0.5 m).

Bimonthly grab samples were collected from 6/29/2015 to 10/20/2015.

The BGA species and microcystin data indicate that *Microcystis* had a relatively large peak (bloom) in July, at which time the concentrations of *Microcystis*-associated toxin microcystin was also relatively high (Figure 13). This bloom occurred before the curtain was fully deployed and *Microcystis* and microcystin concentrations also were relatively high in the river downstream of Iron Gate dam. The BGA *Aphanizomenon flos-aquae* (*Aphanizomenon*) bloomed later in the year than *Microcystis* (Figure 13). Starting in late July, after the curtain was deployed to depths of 7.6 m (25 ft) or more, *Microcystis* and *Aphanizomenon* concentrations were relatively low downstream of the curtain and in the Klamath River downstream of Iron Gate dam. This indicated that near-surface upstream reservoir waters were isolated and *Microcystis* and *Aphanizomenon* were not readily passing to the river downstream.

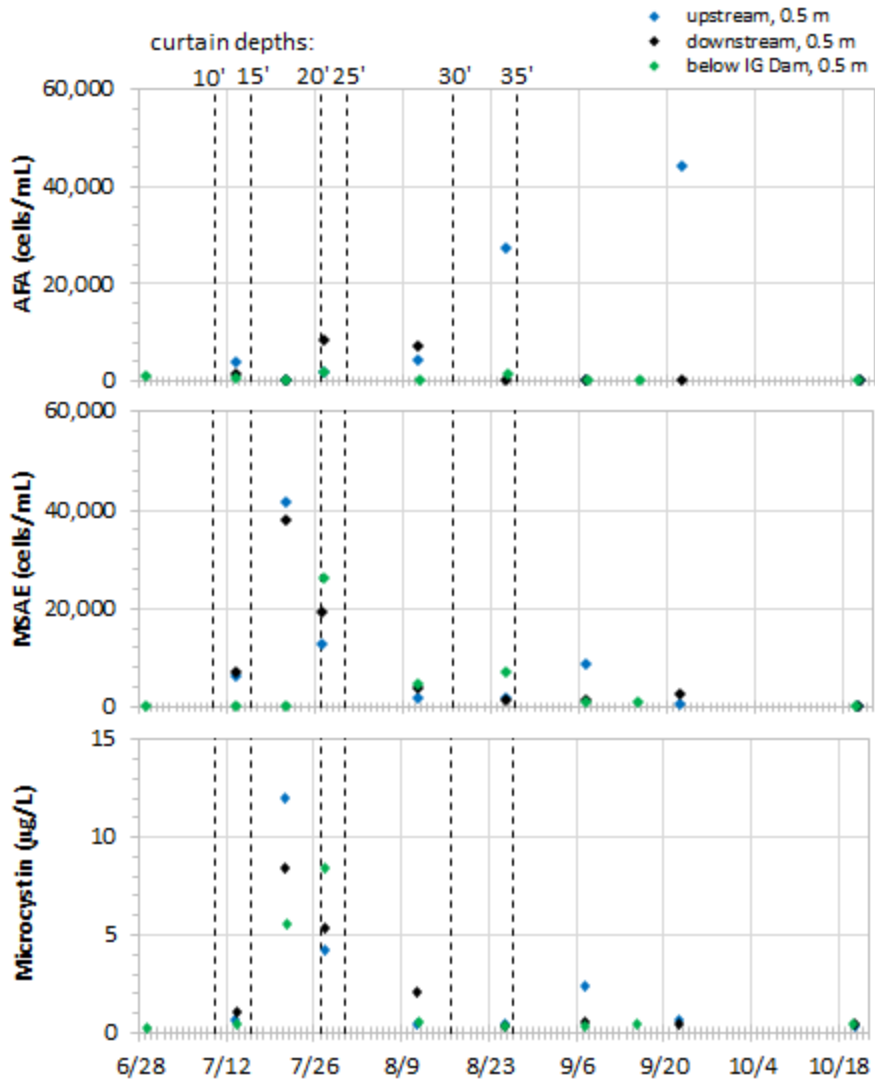

Figure 13. *Aphanizomenon flos-aquae*, *Microcystis aeruginosa*, and Microcystin Results Upstream and Downstream of the Curtain, and Below Iron Gate Dam, Taken Near the Surface (0.5 m).

Bimonthly grab samples were collected from 6/29/2015 to 10/20/2015.

### 3.2.2.2 Depth Samples

Multiyear (2009 to 2015) comparisons of TN, NH<sub>3</sub>-N, NO<sub>3</sub>+NO<sub>2</sub>, TP, and PO<sub>4</sub> were developed to identify potential effects of the curtain on nutrient levels downstream (Figure 14 to Figure 18). These nutrient data were collected as part of the KHSA monitoring program that began in 2009. The data illustrate that concentrations generally lie within the typical range of nutrient levels observed downstream for the periods from 2009 to 2014.



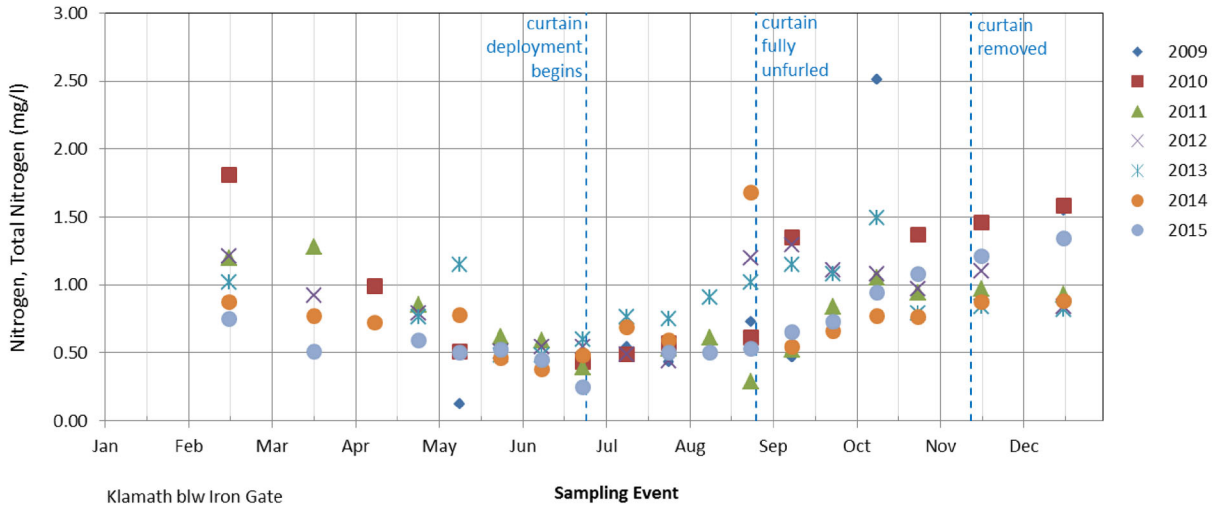

Figure 14. Comparison of Total Nitrogen (mg/L) Concentrations Below Iron Gate Dam from 2009 to 2015.

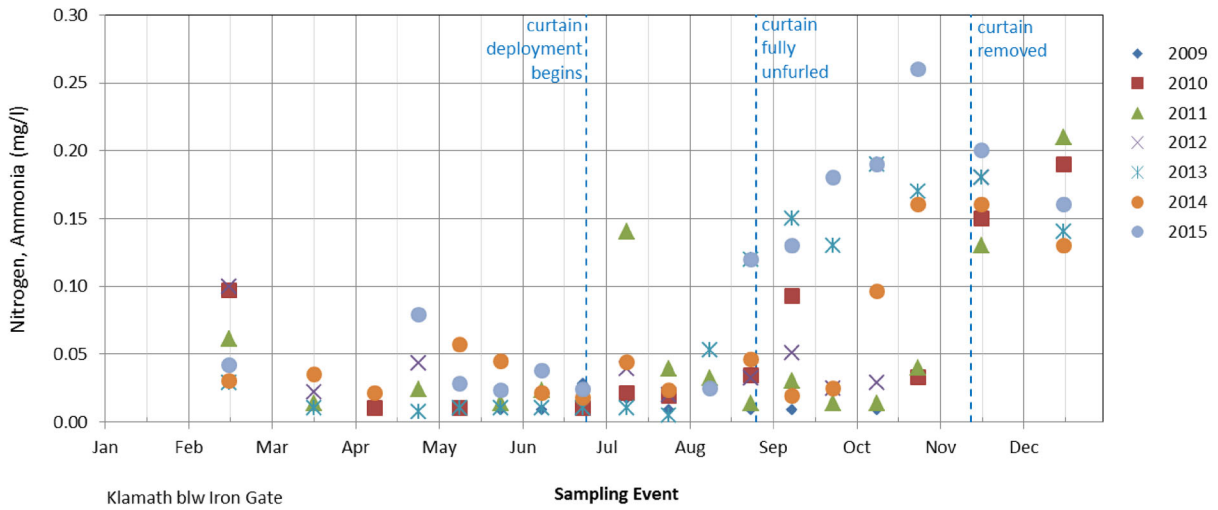

Figure 15. Comparison of Ammonia Nitrogen (mg/L) Concentrations Below Iron Gate Dam from 2009 to 2015.

### 3 Study Activities

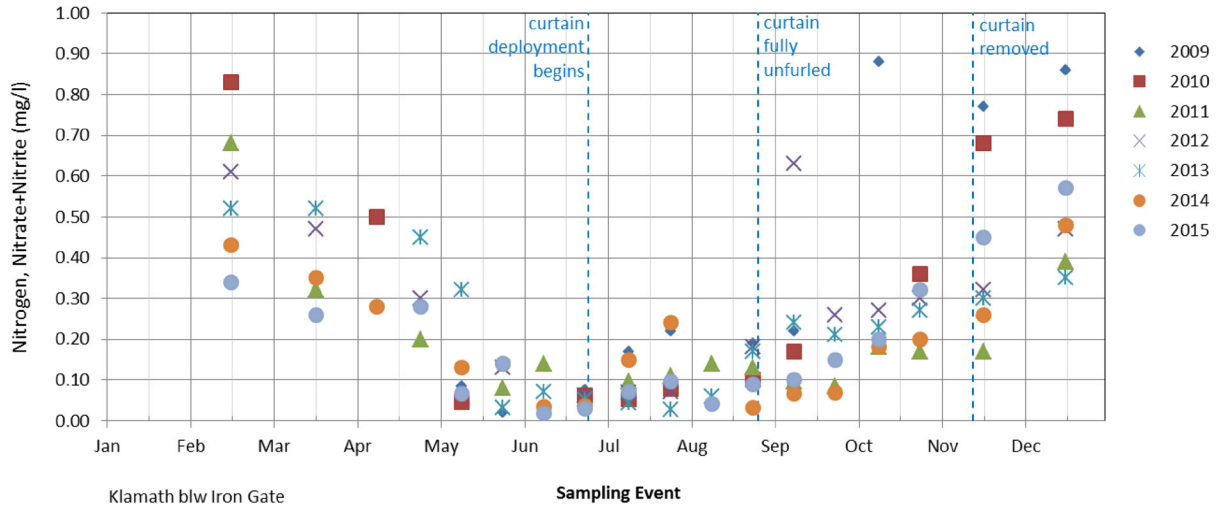

Figure 16. Comparison of Nitrate Nitrogen (mg/L) Concentrations Below Iron Gate Dam from 2009 to 2015.

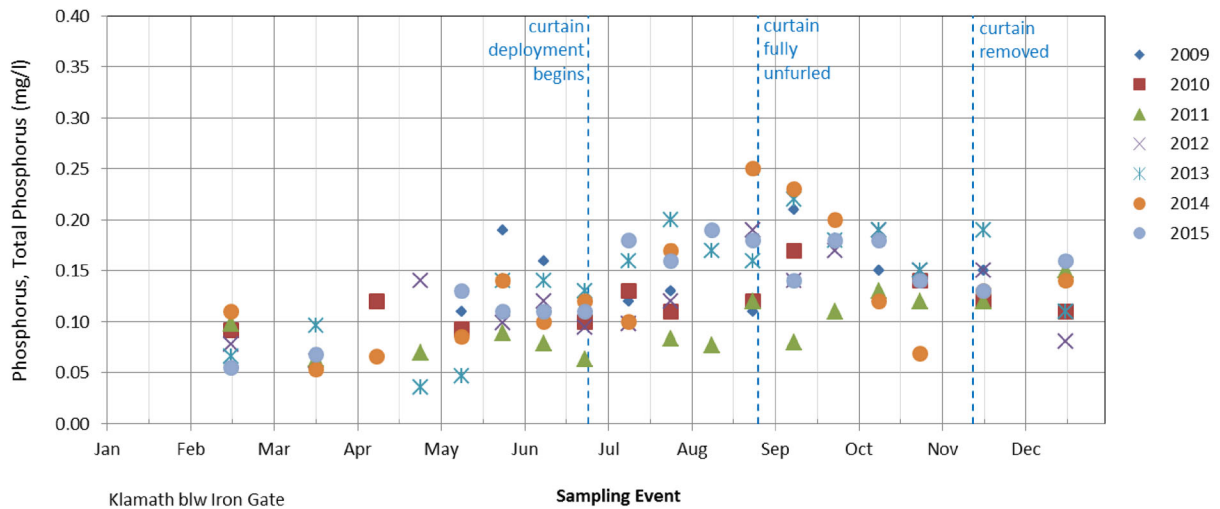

Figure 17. Comparison of Total Phosphorus (mg/L) Concentrations Below Iron Gate Dam from 2009 to 2015.

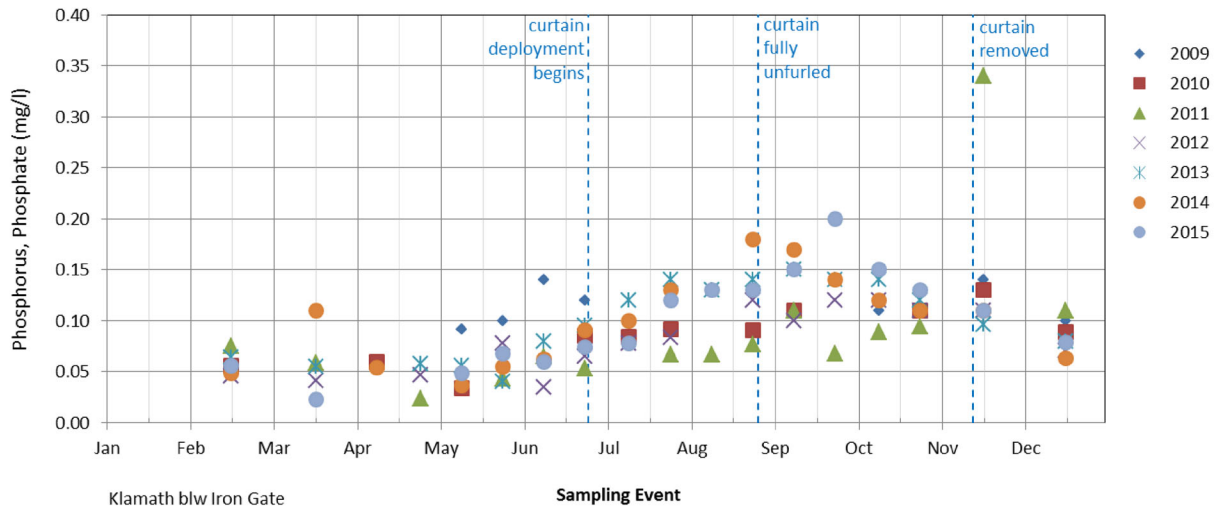

Figure 18. Comparison of Phosphate Phosphorus (mg/L) Concentrations Below Iron Gate Dam from 2009 to 2015.

Samples collected at 12 m (39.4 ft) represent waters beneath the maximum deployment depth of the curtain and beneath the photic zone both upstream and downstream of the curtain. Samples from deeper waters reflect the accumulation of dissolved inorganic nutrients beneath the photic zone that is not utilized by algae and the accumulation of nutrients in organic matter (e.g., settling detritus due to algae mortality). These data are compared with the Klamath River downstream at 0.5 m (1.6 ft).

TN concentrations at all three locations were similar and all showed an increasing trend throughout the study period regardless of curtain depth (Figure 19). When the curtain reached maximum depth, TN downstream of the curtain was slightly higher than upstream of the curtain. This suggests that waters deeper than 12 m (39.4 ft), which had higher nutrient concentrations, may have been entrained in the flow under the curtain. This more nutrient-rich water would have thereby contributed to slightly higher TN values downstream of the curtain.

In early July,  $\text{NH}_3$  concentrations upstream of the curtain were in excess of 0.9 mg/L while little or no  $\text{NH}_3$  was present downstream of the curtain and Iron Gate dam (Figure 19). The  $\text{NH}_3$  concentrations upstream of the curtain likely resulted from low oxygen conditions. For example, the lack of dissolved oxygen and  $\text{NO}_3+\text{NO}_2$  at 12 m (39.4 ft) at this time indicates that conversion of  $\text{NH}_3$  to  $\text{NO}_3+\text{NO}_2$  via nitrification (expected in the presence of dissolved oxygen) was inhibited. Curtain deployment depth on this date was still less than 6 m (20 ft), indicating that deeper waters were not entrained in any meaningful quantity.

$\text{NO}_3+\text{NO}_2$  concentrations were generally variable among the sites during the study period (Figure 19). The magnitude and temporal trend in  $\text{NO}_3+\text{NO}_2$  concentrations were generally consistent between the samples downstream of the curtain and the river samples downstream of Iron Gate dam (Figure 19). The exception was the apparent spike in  $\text{NO}_3+\text{NO}_2$  in the river sample in early September, as discussed in Section 3.2.2.1.

TP and  $\text{PO}_4$  concentrations were similar among sample locations and show a slight mid-season increase (the same as the near-surface sample) (Figure 19). Chlorophyll-*a* data at depth also were similar for the three locations and once the curtain was fully deployed, values were near zero (Figure 19).

### 3 Study Activities

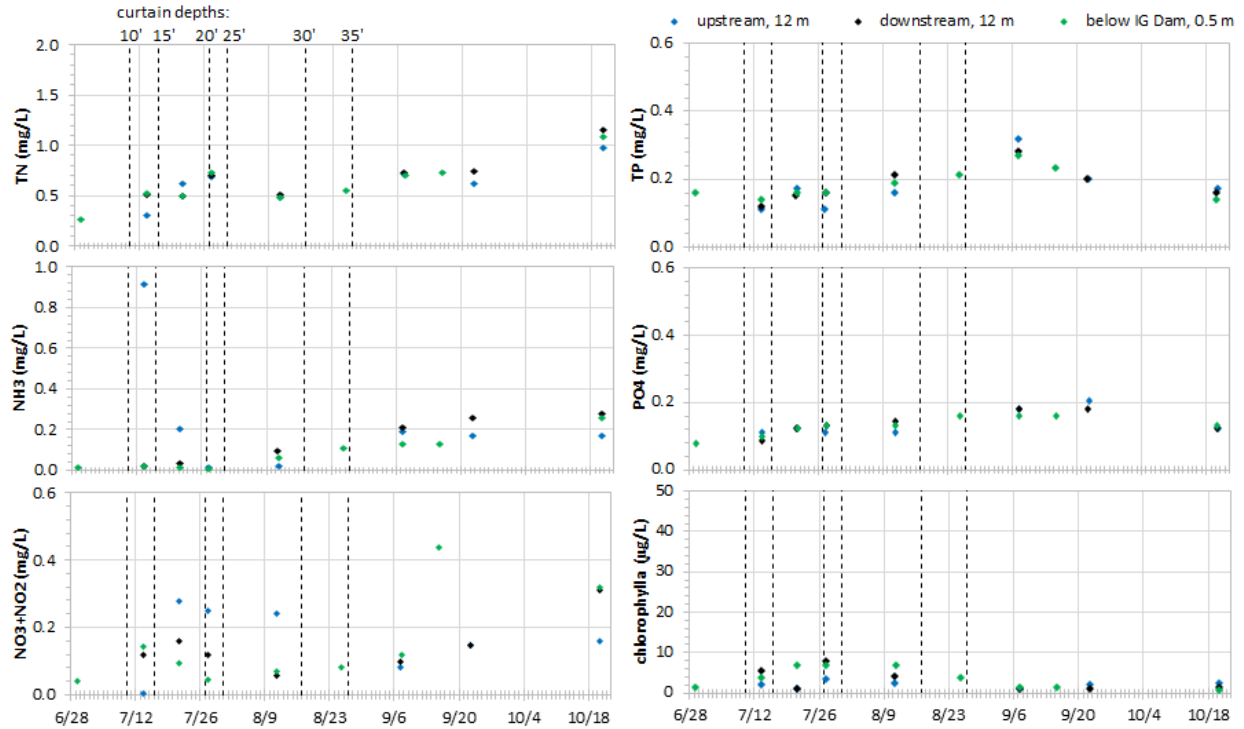

Figure 19. Nutrients and Chlorophyll-*a* Results Upstream and Downstream of the Curtain, and Below Iron Gate Dam, Taken at Depth (12.0 m).

Bimonthly grab samples were collected from 6/29/2015 to 10/20/2015.

The BGA species and microcystin data suggest that algal populations in the deeper waters at 12.0 m (39.4 m) were low for most of the study period (Figure 20). There was a bloom of *Microcystis* in late July that was identified at all three sampling locations. The curtain was deployed to a depth of 6.1 m (20 ft) at this time. It is possible that waters passing under the curtain could have entrained near-surface algae upstream of the curtain at this shallower curtain depth. After the curtain reached full deployment depth, algae counts and microcystin dropped to near zero (Figure 20).

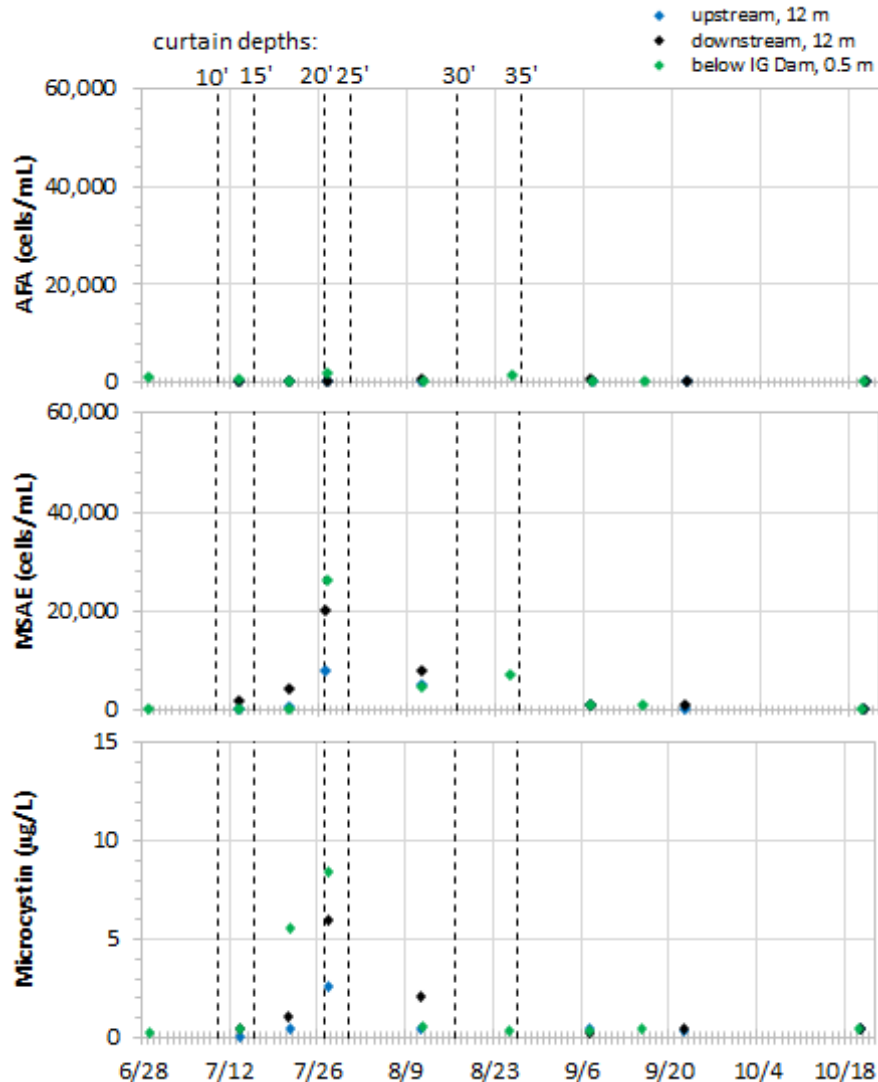

Figure 20. *Aphanizomenon flos-aquae*, *Microcystis aeruginosa*, and Microcystin Results Upstream and Downstream of the Curtain at Depth (12.0 m), and Below Iron Gate Dam.

Bimonthly grab samples were collected from 6/29/2015 to 10/20/2015.

### 3.2.2.3 Integrated Samples

Integrated samples were collected over the depth of 0 to 8 m (26.2 ft) at locations both upstream and downstream of the curtain. These samples extend from the surface through the photic zone and represent conditions where primary production occurs in the reservoir. Integrated sample data are compared with the Klamath River downstream at 0.5 m (1.6 ft).

TN concentrations at all three locations were similar and all showed an increasing trend throughout the study period regardless of curtain deployment depth (Figure 21). This pattern is the same as was observed in both surface and depth grab samples (Sections 3.2.2.1 and 3.2.2.2). When the curtain was at its maximum depth, TN downstream of the curtain was slightly higher than upstream of the curtain. As described for the surface samples at 0.5 m (1.6 ft), these slightly higher concentrations in the integrated samples are likely a result of entrainment of deeper waters and more nutrient uptake from primary production in the photic zone (see Section 3.2.2).

The trend of  $\text{NH}_3$  data during the study period is similar to the TN data trend (Figure 21). The  $\text{NH}_3$  spike in July identified in the 12 m (39.4 m) sample did not manifest itself in this integrated sample. After the curtain reached its maximum depth, inorganic nitrogen ( $\text{NH}_3$  and  $\text{NO}_3+\text{NO}_2$ ) continued to increase (Figure 21). The spike in  $\text{NO}_3+\text{NO}_2$  in early September may be related to the variable flow operations that commenced on the first of September.

TP and  $\text{PO}_4$  concentrations in the integrated samples were intermediate between the concentrations from the 0.5 m (1.6 ft) and 12 m (39.4 ft) sample depths (Figure 21). TP and  $\text{PO}_4$  concentrations in the integrated samples were generally less variable than in the 0.5 m (1.6 ft) samples.

Chlorophyll-*a* concentrations in the integrated samples were similar for the locations downstream of the curtain and below Iron Gate dam, but generally higher at the upstream location (Figure 21). The chlorophyll-*a* concentration at the upstream location was particularly higher in mid-September. This high mid-September value even exceeded that observed in the near-surface sample at the upstream location (Figure 12), suggesting that the near-surface sample did not necessarily represent all of the primary production present in the photic zone. After the curtain reached its maximum depth, chlorophyll-*a* values downstream of curtain and in the Klamath River downstream of Iron Gate dam were near zero while upstream of the curtain chlorophyll-*a* reached a seasonal peak in late September (Figure 21).

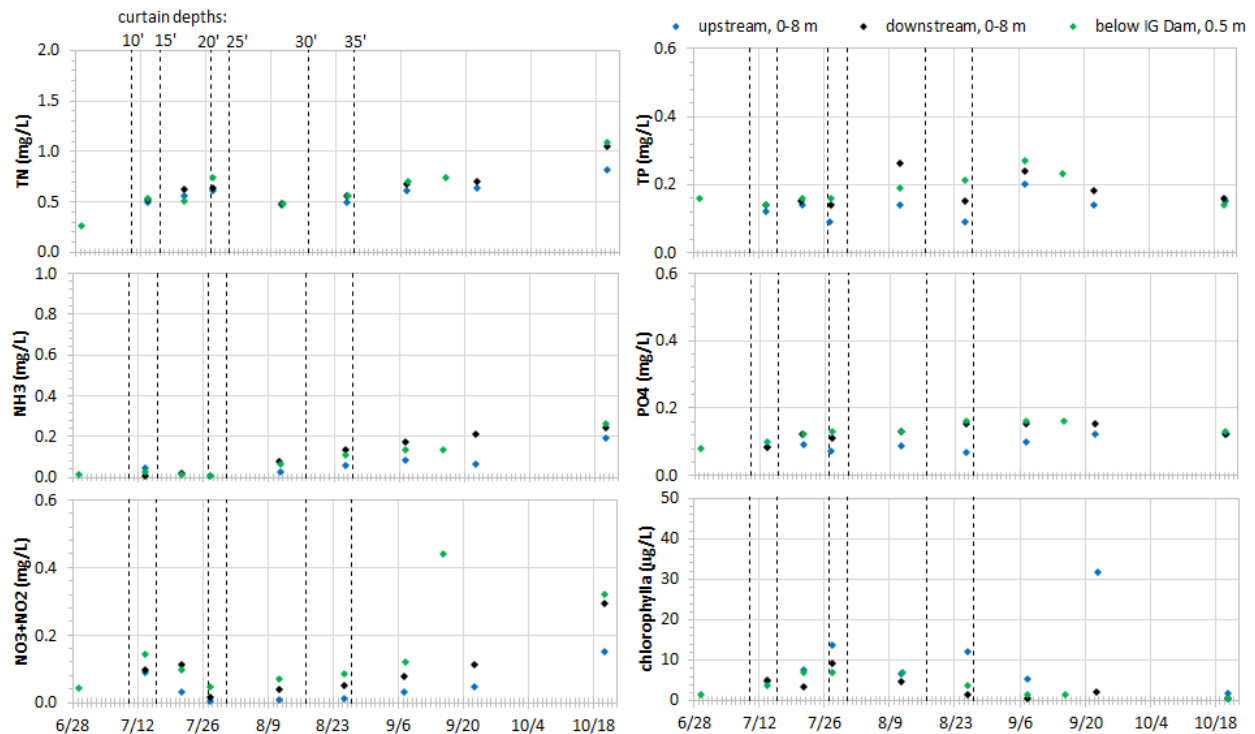

Figure 21. Nutrients and Chlorophyll-*a* Integrated Sample (0-8 m) Results Upstream and Downstream of the Curtain, and Below Iron Gate Dam.

Note: Bimonthly integrated grab samples were collected by E&S Environmental Chemistry, Inc., from 6/29/2015 to 10/20/2015.

Algae species and microcystin results indicate that starting in late July, after the curtain was deployed to depths of 7.6 m (25 ft) or more, values for *Microcystis*, *Aphanizomenon*, and microcystin gradually declined over time and dropped to near zero downstream of the curtain (Figure 22). During this same period, there were notable concentrations of *Microcystis* and *Aphanizomenon* in the integrated sample upstream of the curtain. Similar to chlorophyll-*a*, *Microcystis* was present in the integrated sample, but

absent in the near-surface sample (Figure 13), implying that the near-surface sample did not necessarily represent the concentration of *Microcystis* present in the photic zone.

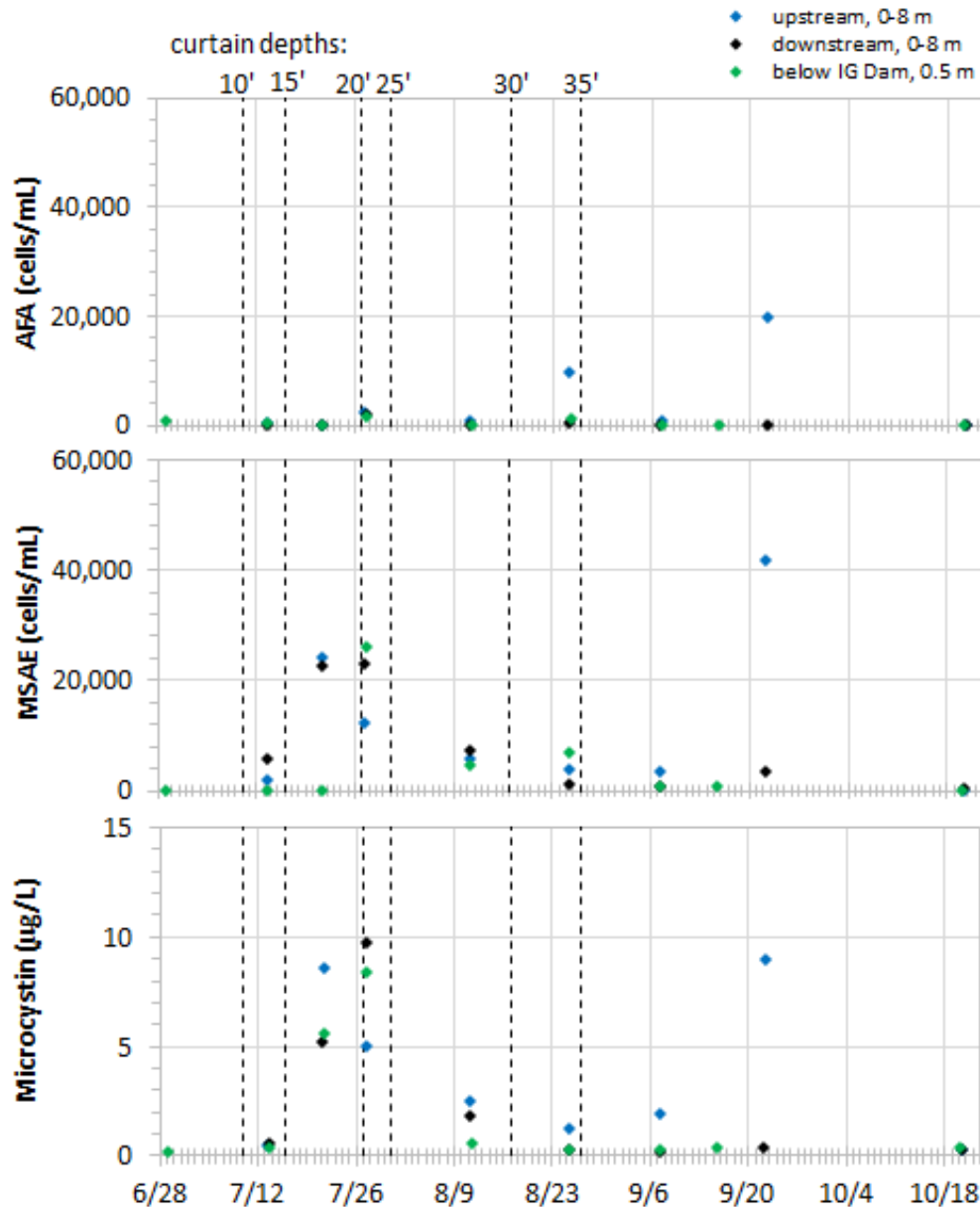

Figure 22. *Aphanizomenon flos-aquae*, *Microcystis aeruginosa*, and Microcystin Integrated Sample (0-8 m) Results Upstream and Downstream of the Curtain, and Below Iron Gate Dam.

Note: Bimonthly integrated grab samples were collected from 6/29/2015 to 10/20/2015.

#### 3.2.2.4 Comparison with Other Years

Algae blooms in Iron Gate reservoir vary both intra- and interannually. To compare conditions in 2015 with previous years, algae species and microcystin from the past 5 years were reviewed to illustrate the interannual variability of algae population in the system, as well as to provide a frame of reference for the conditions observed during the study. Three KHSA IM15 baseline water quality monitoring locations are presented: Copco reservoir at cable boom (surface) (KR19874), Iron Gate reservoir at log boom (surface)

(KR19019), and below Iron Gate dam (KR18973). Microcystin levels, *Microcystis* cell counts, and *Aphanizomenon* cell counts for June-August 2010-2015 are included in Figure 23, Figure 24, and Figure 25, respectively. These figures present baseline water quality sampling results which are intended to represent conditions in the open areas of the reservoirs and within the main channel of the river. Public health samples focus on shoreline scums and areas of highest algae accumulation that may not be representative of conditions that could be influenced by the intake barrier curtain. Thus, to compare open-body areas in the reservoir with downstream conditions, the data from the baseline sampling locations was deemed most appropriate.

This data indicates that interannual differences are notable at all locations, with the reservoir locations illustrating the largest differences. Relatively low amounts of *Microcystis*, and *Aphanizomenon* were observed in 2015, but 2011 and 2014 had similar or even lower concentrations. Collectively, 2015 appears to have been a relatively less-abundant year for BGA blooms, with levels appreciably lower than those observed in 2010, 2012, and 2013.

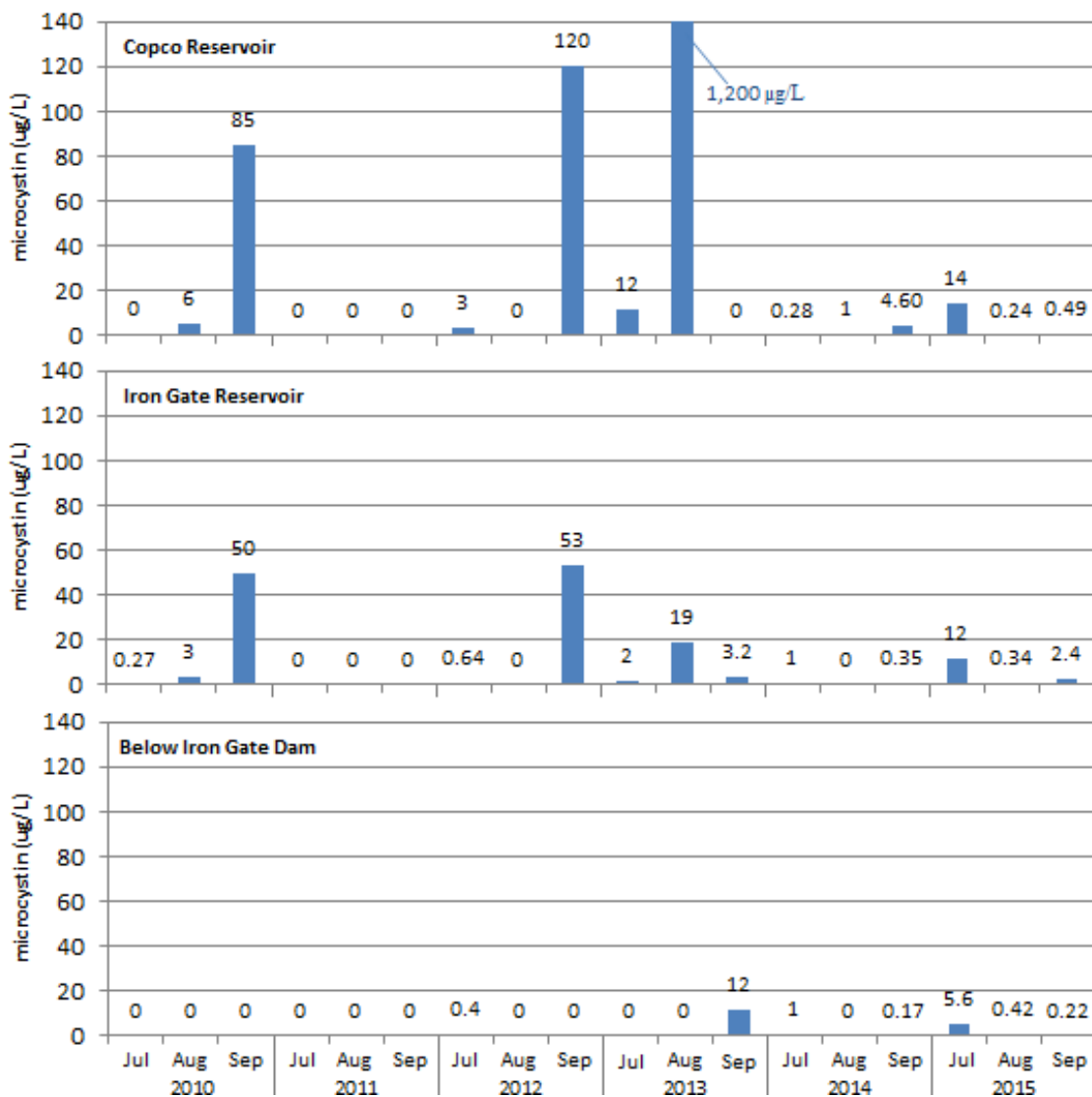

Figure 23. Comparison of Microcystin Concentrations (µg/L) in Copco Reservoir at Cable Boom, Iron Gate Reservoir at Log Boom, and Below Iron Gate Dam in July, August, and September from 2010-2015.



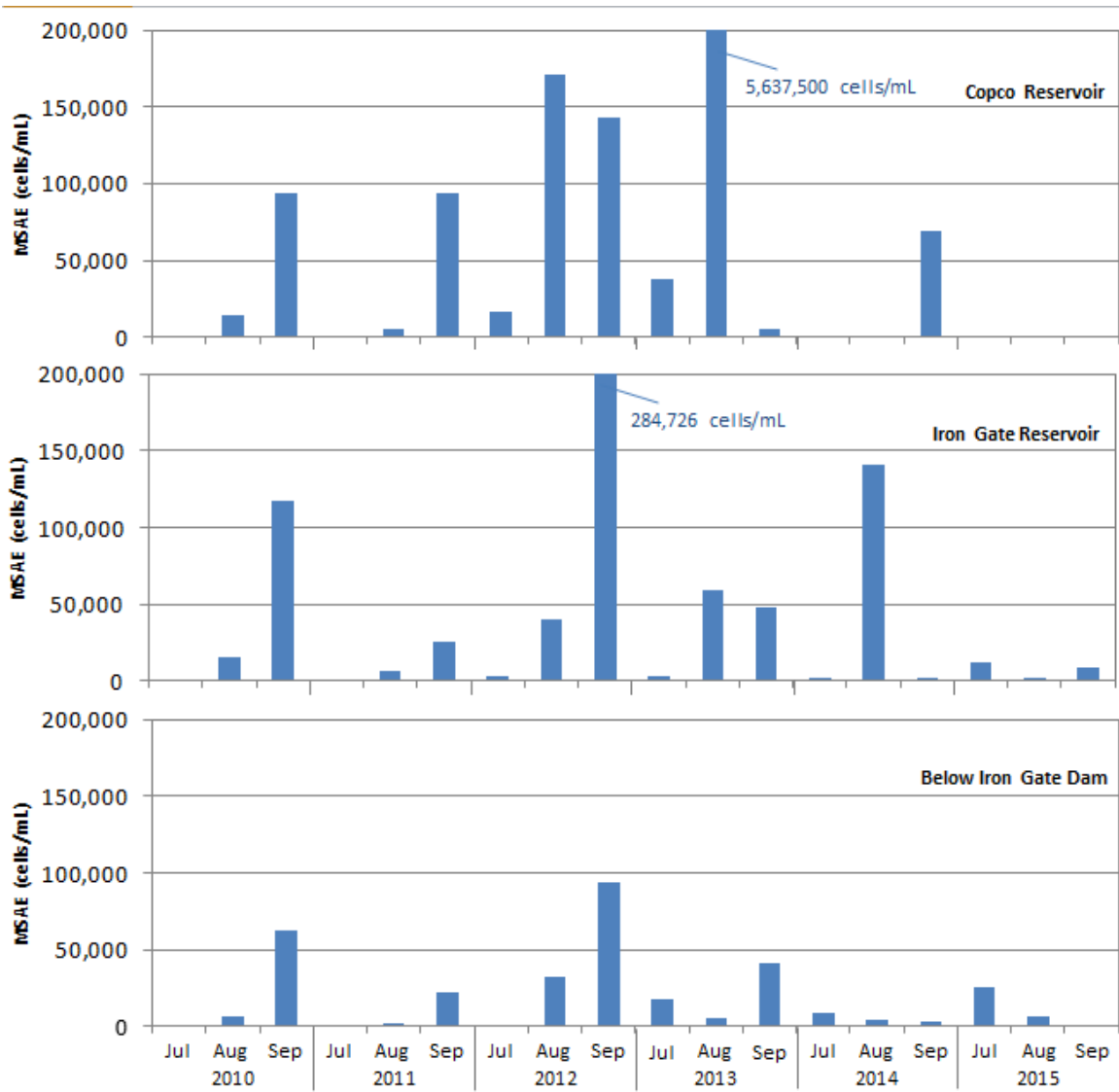

Figure 24. Comparison of *Microcystis aeruginosa* Density (cells/mL) in Copco Reservoir at Cable Boom, Iron Gate Reservoir at Log Boom, and Below Iron Gate Dam in July, August, and September from 2010-2015.

### 3 Study Activities

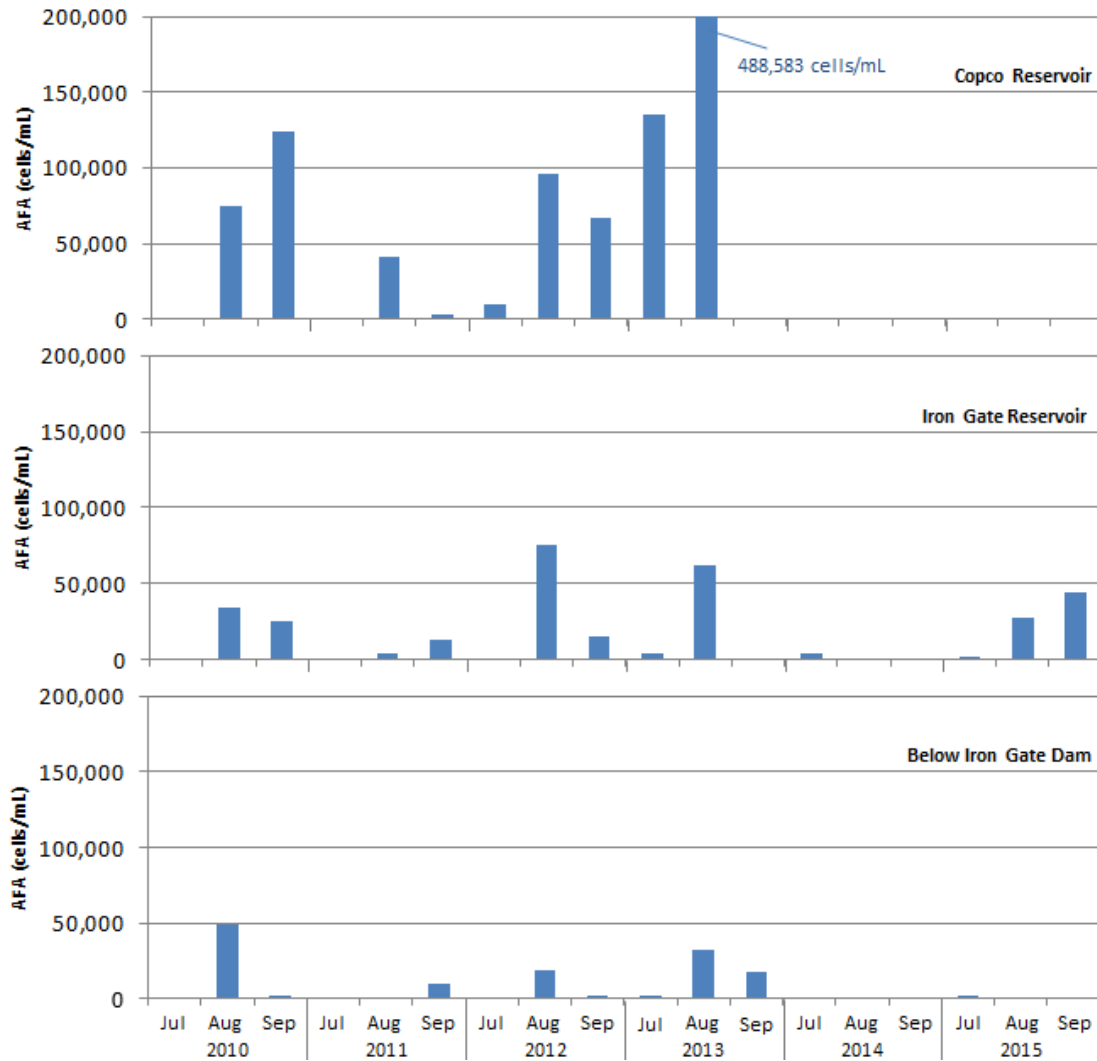

Figure 25. Comparison of *Aphanizomenon flos-aquae* Cell Counts (cells/mL) in Copco Reservoir at Cable Boom, Iron Gate Reservoir at Log Boom, and Below Iron Gate Dam in July, August, and September from 2010-2015.

Microcystin data from the KHSAs baselines water quality monitoring program for 2009-2015 were examined to assess interannual variability for Copco and Iron Gate reservoirs, and the Klamath River below Iron Gate dam (Figure 26 to Figure 28). Consistent with the species data presented above, 2015 appears to have been a relatively less-abundant year for BGA blooms, leading to relatively low levels of microcystin.

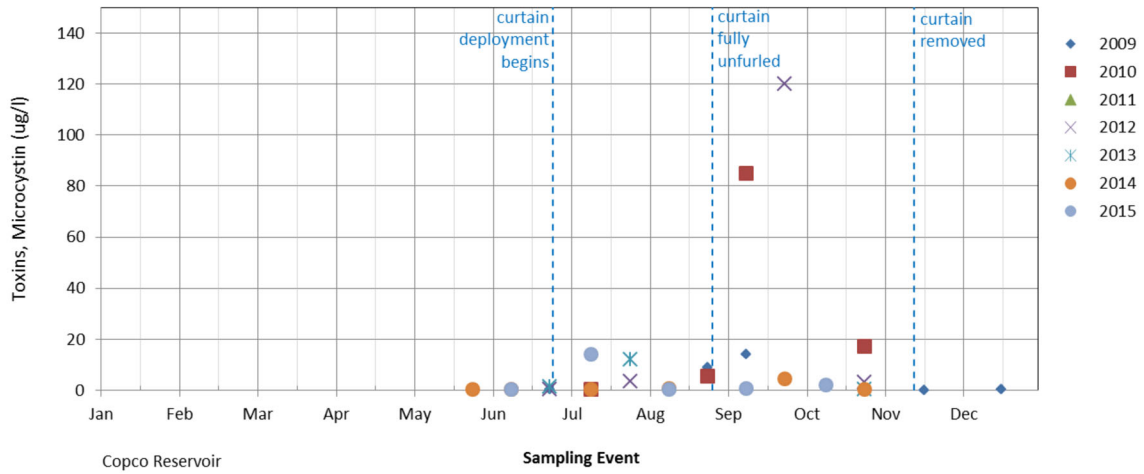

Figure 26. Comparison of Microcystin Levels (µg/L) in Copco Reservoir from 2009-2015. (August 25, 2013, microcystin data were at 1,200 (µg/L).)

Note: y-axis range from 0 to 150 µg/L.

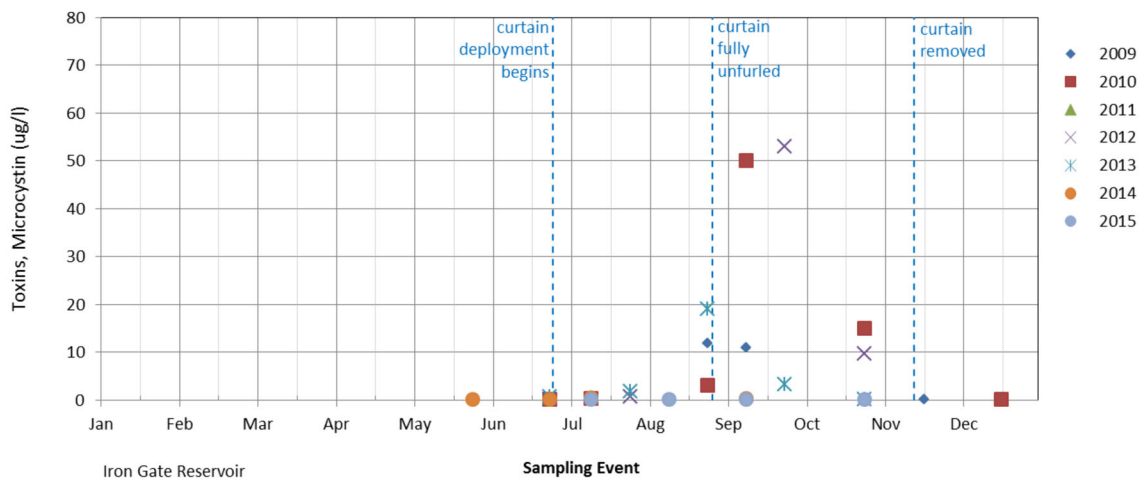

Figure 27. Comparison of Microcystin Levels (µg/L) in Iron Gate Reservoir from 2009-2015.

Note: y-axis range from 0 to 80 µg/L.

### 3 Study Activities

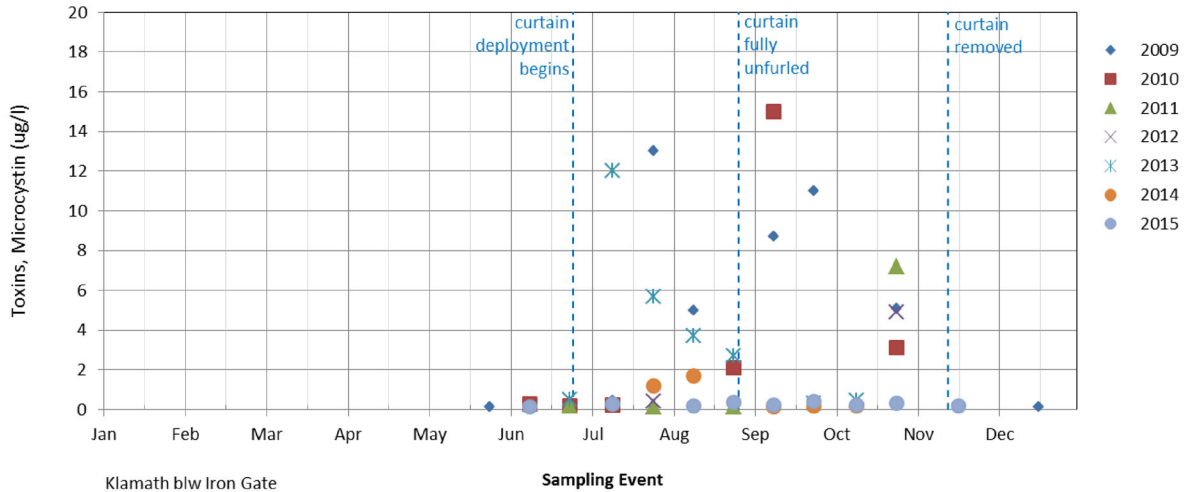

Figure 28. Comparison of Microcystin Levels ( $\mu\text{g/L}$ ) Below Iron Gate Dam from 2009-2015.

Note: y-axis range from 0 to 20  $\mu\text{g/L}$ .

Upstream locations also experience variable microcystin concentrations both inter- and intraannually, which can affect the amount of microcystin that comes into PacifiCorp’s reservoirs from upstream sources. Variability in microcystin is evident, for example, in data collected from baseline water quality samples collected over several years in the Klamath River downstream of Iron Gate reservoir and at Link River dam, the outflow from Upper Klamath Lake (Figure 29). The pattern of higher concentrations downstream of Iron Gate dam as compared to Link River dam from 2010 through 2013 reversed in 2014 when microcystin levels at Link River dam were higher than those downstream of Iron Gate reservoir. This pattern repeats in 2015 with microcystin levels at Link River dam remaining substantially higher than those in the Klamath below Iron Gate dam throughout the period during the curtain study. There are many factors that influence microcystin concentrations between Link River dam and downstream of Iron Gate dam including riverine and reservoir reach processes, tributary and spring flow accretions, and other conditions. Nonetheless, these data illustrate notable variability in microcystin concentrations in both space and time in the Klamath River basin.

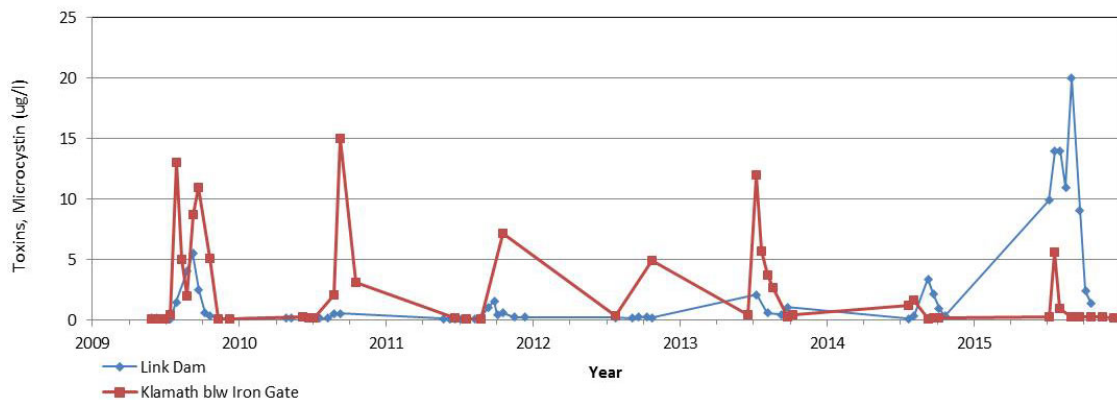

Figure 29. Total Microcystin at Link River Dam and the Klamath River Below Iron Gate Dam from 2009-2015 Baseline Water Quality Samples.

Nutrient samples indicated differences between nutrient concentrations upstream and downstream of the curtain. While direct with-curtain and without-curtain comparisons are complex, TN and TP data from above Copco reservoir and below Iron Gate dam indicate the reservoir system is behaving within the range of historical conditions. These data also indicate the curtain does not cause nutrient concentrations downstream of Iron Gate dam to deviate from levels normally observed (Figure 30).

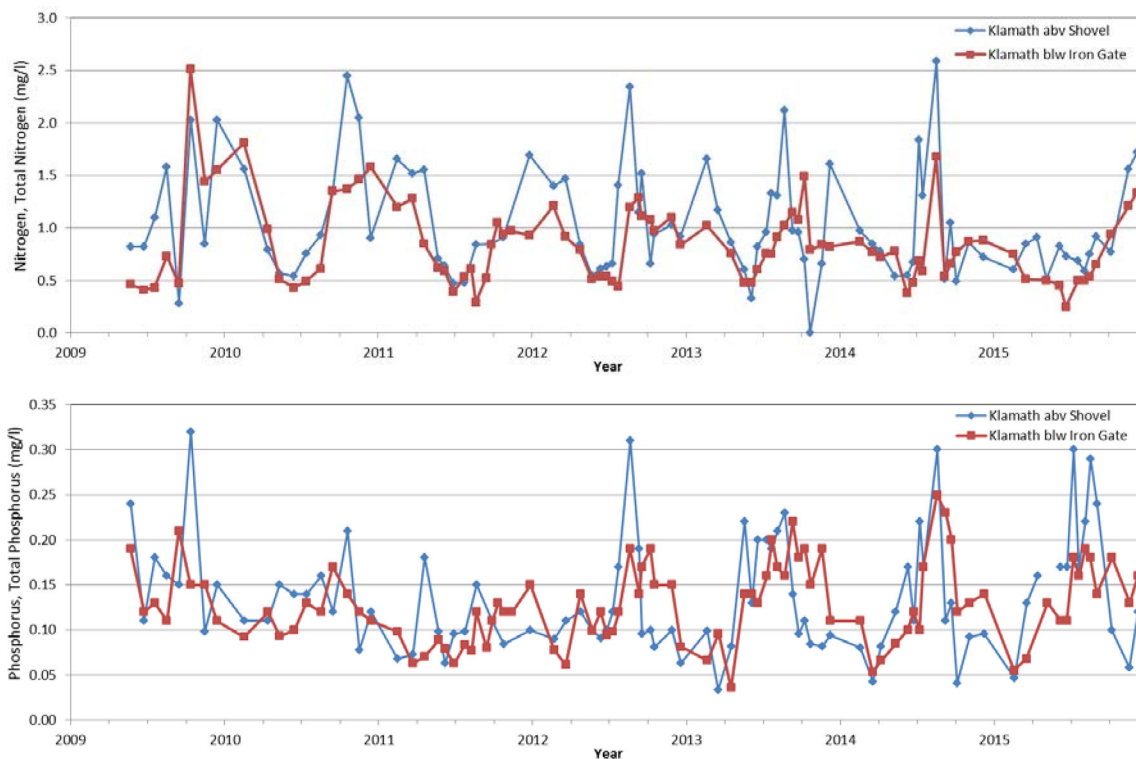

Figure 30. TN and TP Above Copco Reservoir (near Shovel Creek) and Below Iron Gate Dam from 2009 to 2015.

### 3.2.3 Summary

Bimonthly sampling results for nutrients, chlorophyll-*a*, BGA species, and microcystin upstream and downstream of the curtain and below Iron Gate Dam highlight the effects of the curtain on these constituents. Samples from the surface (0.5 m [1.6 ft]) showed clear differences upstream and downstream of the curtain because downstream of the curtain the water were largely derived from deeper upstream water. Samples taken at depth (12.0 m [39.4 ft]) upstream and downstream of the curtain were for the most part similar. The integrated samples (0-8 m [26.2 ft]) more completely represented conditions in the photic zone, were less variable than the surface samples, and illustrated that the photic zone probably is not completely represented by a 0.5 m (1.6 ft) grab sample.

Nutrient samples indicated differences between nutrient concentrations upstream and downstream of the curtain. An examination of TN and TP data from above Copco reservoir and below Iron Gate dam indicate the reservoir system is behaving within the range of historical conditions. These data also indicate the curtain does not cause nutrient concentrations downstream of Iron Gate dam to deviate from levels normally observed.

Overall, results of the grab sample program further support that a curtain deployed to depths of 7.6 m (25 ft) or more effectively segregates the surface waters upstream of the curtain, reducing the entrainment

of BGA into the intake tower and its corresponding release into the Klamath River downstream of Iron Gate dam.

#### 3.3 MULTIDAY, SHORT-TERM AUTOSAMPLING

Autosamplers were deployed over multiple days upstream of the curtain and downstream of Iron Gate dam during 2015. The objective of this study element was to assess and compare short-term variability and conditions in near-surface waters upstream of the curtain (those presumed to be retained in the reservoir), and in the Klamath River below Iron Gate dam.

##### 3.3.1 Methodology

The multiday autosampling study was performed from August 31 to September 4, 2015. Autosamplers were deployed upstream of the curtain (“Upstream of Curtain” site in Figure 5; Figure 31) and downstream of Iron Gate dam (“Multiday Autosampler Site” in Figure 5; Figure 32).

Both autosamplers were programmed to take coincident samples at 4-hour intervals from a depth of 0.5 m. The experiment was originally planned as a continuous 72-hour study. However, a temporary malfunction of the autosampler at the upstream site resulted in no samples being collected on the second day. To compensate for this gap, the experiment was extended for another 24 hours in order to collect samples from both upstream and downstream for a 72-hour period.

Samples collected for algae species analyses were stored in 125-milliliter (mL) bottles preserved with Lugol’s solution and chilled but not frozen. Algae species analyses were performed by Aquatic Analysts, Inc., in Friday Harbor, Washington. Samples collected for microcystin were stored in 125-mL glass bottles and frozen. The frozen microcystin samples were delivered to U.S. Environmental Protection Agency Region 9 laboratory in Richmond, California. Chlorophyll-*a* samples were filtered onto 47-mm filter pads that were frozen and shipped to Chesapeake Bay Laboratory in Solomons, Maryland.

PacifiCorp developed a process to automatically adjust flow releases from the Iron Gate powerhouse and provide a diurnal, variable pattern that could be implemented within existing flow constraints. With the concurrence of the National Marine Fisheries Service, this variable flow pattern was implemented on September 1, 2015, and commenced after the start of the autosampler sampling period (8/31-9/4). The resulting flow change may have affected downstream water quality conditions and impacted these autosampler results, as noted in the discussion below.

The Iron Gate intake structure, even without the intake barrier in place, withdraws water from a range of depths from the water surface down to the reservoir bottom in the vicinity of the intake, which has an invert elevation approximately 30 to 35 ft below typical water surface elevations. Thus, surface waters in the reservoir will contribute a fraction of water discharged to the Klamath River downstream and a direct comparison of samples from the reservoir surface and from the river downstream of Iron Gate dam does not necessarily reflect the effectiveness of the intake barrier curtain. Nonetheless, the autosampler study provides useful information on diel variability in water quality conditions and comparisons between near-surface reservoir and river conditions, which represent reservoir outflow quality.



Figure 31. Autosampler Located Upstream of the Curtain in Iron Gate Reservoir.



Figure 32. Autosampler Located Adjacent to the Klamath River Downstream of Iron Gate Dam.

### 3.3.2 Results

Autosampler results comparing upstream and downstream sampling locations for microcystin, algae species (*Microcystis* and *Aphanizomenon*), and chlorophyll-*a* are presented below.

#### 3.3.2.1 Microcystin

Microcystin results from the 72-hour deployment indicate that concentrations in the Klamath River below Iron Gate dam were equal to or lower than upstream concentrations in the reservoir for all but one sample (Figure 33). Daily average reductions from upstream of the curtain to the Klamath River below Iron Gate dam averaged 64 percent and ranged from 25 to 84 percent (Table 1).

Autosampler study results also illustrated that the diurnal variability of microcystin concentrations was greater upstream of the curtain than in the Klamath River downstream of the dam. The greater overall variability in the microcystin concentrations in the reservoir upstream of the curtain may be a result of meteorological conditions, the heterogeneous nature of in-reservoir algae conditions, and vertical movement of BGA through the water column over time. Microcystin variability in the Klamath River below Iron Gate dam was notably lower than in the reservoir, likely because water released from the powerhouse is well mixed such that constituents such as microcystin are more evenly dispersed and distributed through the river as compared to the reservoir.

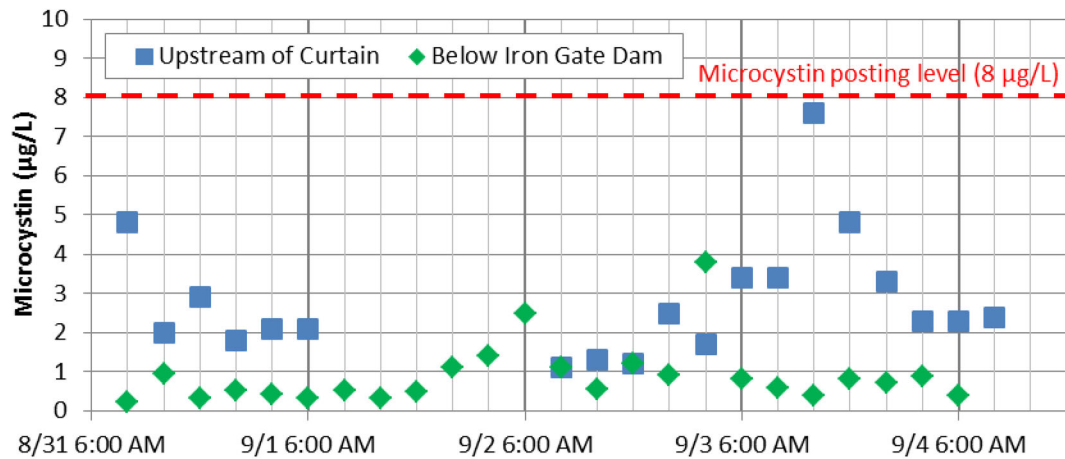

Figure 33. Microcystin Data from Samples Collected over a 96-hour Sampling Period Using Autosamplers Upstream of the Curtain and Below Iron Gate Dam.

Samples were taken from a depth of 0.5 m. California State Water Resources Control Board (SWRCB) 2010 Guideline of 8 µg/L or greater for microcystin for posting advisories in recreational waters is shown as the red dashed line.

Table 1. Summary of Microcystin Concentrations in Samples Taken During Multiday Autosampler Experiment.

		<b>Microcystin (µg/l)</b>			
	<b>Upstream of Curtain</b>	<b>Below Iron Gate Dam</b>			
8/31/15 10:00	4.8	0.23			
8/31/15 14:00	2.0	0.96	<u>24-hour Summary:</u>		
8/31/15 18:00	2.9	0.34	24-hour Avg. (Upstream of Curtain):	2.6	(n=6)
8/31/15 22:00	1.8	0.51	24-hour Avg. (Below Iron Gate Dam):	0.47	(n=6)
9/1/15 2:00	2.1	0.43	% Reduction of 24-hour Avg.:	82%	
9/1/15 6:00	2.1	0.33			
9/1/15 10:00	n/a	0.53			
9/1/15 14:00	n/a	0.32	<u>24-hour Summary:</u>		
9/1/15 18:00	n/a	0.50	24-hour Avg. (Upstream of Curtain):	n/a	
9/1/15 22:00	n/a	1.10	24-hour Avg. (Below Iron Gate Dam):	1.06	(n=6)
9/2/15 2:00	n/a	1.40	% Reduction of 24-hour Avg.:	n/a	



Table 1. Summary of Microcystin Concentrations in Samples Taken During Multiday Autosampler Experiment.

Microcystin ( $\mu\text{g/l}$ )						
	Upstream of Curtain	Below Iron Gate Dam				
9/2/15 6:00	n/a	2.50				
9/2/15 10:00	1.1	1.1				
9/2/15 14:00	1.3	0.55	<u>24-hour Summary:</u>			
9/2/15 18:00	1.2	1.20	24-hour Avg. (Upstream of Curtain):	1.9	(n=6)	
9/2/15 22:00	2.5	0.93	24-hour Avg. (Below Iron Gate Dam):	1.40	(n=6)	
9/3/15 2:00	1.7	3.80	% Reduction of 24-hour Avg.:	25%		
9/3/15 6:00	3.4	0.83				
9/3/15 10:00	3.4	0.59				
9/3/15 14:00	7.6	0.39	<u>24-hour Summary:</u>			
9/3/15 18:00	4.8	0.83	24-hour Avg. (Upstream of Curtain):	4.0	(n=6)	
9/3/15 22:00	3.3	0.73	24-hour Avg. (Below Iron Gate Dam):	0.64	(n=6)	
9/4/15 2:00	2.3	0.90	% Reduction of 24-hour Avg.:	84%		
9/4/15 6:00	2.3	0.41				
9/4/15 10:00	2.4	n/a				
			72-hour Avg. (Upstream of Curtain):	2.81	(n=18)	
			72-hour Avg. (Below IG Dam):	0.84	(n=18)	
			% Reduction of 72-hour Avg.:	70%		

### 3.3.2.1.1 Algae Species

Algae speciation analyses from the autosamplers identified significant reductions in *Microcystis* (Figure 34, Table 2) and *Aphanizomenon* (Figure 35, Table 3) cell counts below Iron Gate dam as compared cell counts upstream of the curtain. Daily average reductions in *Microcystis* from upstream of the curtain to the Klamath River below Iron Gate dam averaged 82 percent and ranged from 74 to 92 percent (Table 2). Similarly, the daily average reduction in *Aphanizomenon* was 97 percent and ranged from 93 to 99 percent (Table 3).

The *Microcystis* and *Aphanizomenon* cell counts upstream of the curtain displayed diurnal variation, presumably corresponding to algal dependence on sunlight for photosynthesis. *Aphanizomenon* cell counts exceeded *Microcystis* cell counts in Iron Gate reservoir. Below Iron Gate dam, the *Aphanizomenon* and *Microcystis* levels were reduced relative to what was observed upstream of the curtain. This suggests that the curtain was effective in reducing the amount of algae that gets transported downstream.

3 Study Activities

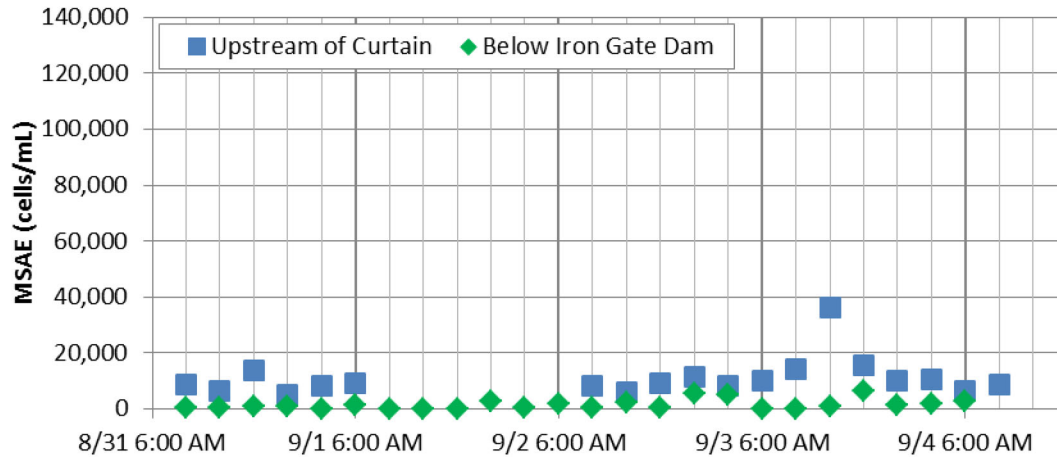

Figure 34. *Microcystis aeruginosa* Cell Counts from Samples Collected over a 96-hour Sampling Period using Autosamplers Upstream of the Curtain and Below Iron Gate Dam.

Samples were taken from a depth of 0.5 m.

Table 2. Summary of *Microcystis aeruginosa* Cell Counts (cells/mL) in Samples Taken During Multiday Autosampler Experiment.

<i>Microcystis aeruginosa</i> (cells/mL)					
	Upstream of Curtain	Below Iron Gate Dam			
8/31/15 10:00	866	50			
8/31/15 14:00	622	35			
8/31/15 18:00	1,355	83	<u>24-hr Summary:</u>		
8/31/15 22:00	517	76	24-hr Avg. (Upstream of Curtain):	854	(n=6)
9/1/15 2:00	845	20	24-hr Avg. (Below Iron Gate Dam):	66	(n=6)
9/1/15 6:00	921	133	% Reduction of 24-hr Avg.:	92%	
9/1/15 10:00		0			
9/1/15 14:00		0			
9/1/15 18:00		0	<u>24-hr Summary:</u>		
9/1/15 22:00		207	24-hr Avg. (Upstream of Curtain):	n/a	
9/2/15 2:00		67	24-hr Avg. (Below Iron Gate Dam):	77	(n=6)
9/2/15 6:00		189	% Reduction of 24-hr Avg.:	n/a	
9/2/15 10:00	811	34			
9/2/15 14:00	582	236			
9/2/15 18:00	915	27	<u>24-hr Summary:</u>		
9/2/15 22:00	1,142	549	24-hr Avg. (Upstream of Curtain):	878	(n=6)
9/3/15 2:00	807	516	24-hr Avg. (Below Iron Gate Dam):	228	(n=6)

Table 2. Summary of *Microcystis aeruginosa* Cell Counts (cells/mL) in Samples Taken During Multiday Autosampler Experiment.

<i>Microcystis aeruginosa</i> (cells/mL)					
	Upstream of Curtain	Below Iron Gate Dam			
9/3/15 6:00	1,012	6	% Reduction of 24-hr Avg.:	74%	
9/3/15 10:00	1,429	22			
9/3/15 14:00	1,804	82			
9/3/15 18:00	1,544	662			
9/3/15 22:00	994	147	<u>24-hr Summary:</u>		
			24-hr Avg. (Upstream of Curtain):	1,246	(n=6)
			24-hr Avg. (Below Iron Gate Dam):	228	(n=6)
9/4/15 2:00	1,070	165	% Reduction of 24-hr Avg.:	82%	
9/4/15 6:00	636	289			
9/4/15 10:00	877				
			72-hr Avg. (Upstream of Curtain):	992.78	(n=18)
			72-hr Avg. (Below IG Dam):	173.97	(n=18)
			% Reduction of 72-hr Avg.:	82%	

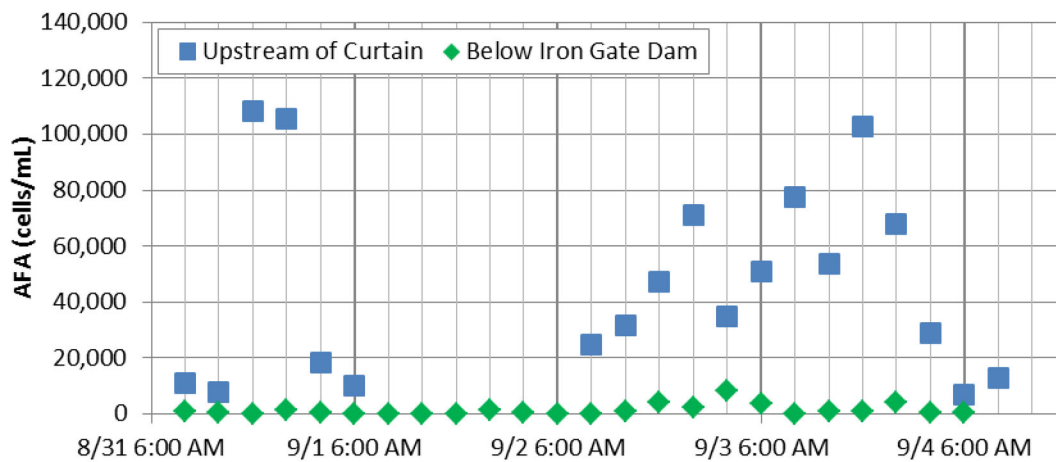

Figure 35. *Aphanizomenon flos-aquae* Cell Counts from Samples Collected Over a 96-hour Sampling Period Using Autosamplers Upstream of the Curtain and Below Iron Gate Dam.

Samples were taken from a depth of 0.5 m.

Table 3. Summary of *Aphanizomenon flos-aquae* Cell Counts (cells/mL) in Samples Taken During Multiday Autosampler Experiment.

<i>Aphanizomenon flos-aquae</i> (cells/mL)					
	Upstream of Curtain	Below Iron Gate Dam			
8/31/15 10:00	11,030	1,024			
8/31/15 14:00	7931	271			
8/31/15 18:00	108,042	199			
			24-hr Summary:		
8/31/15 22:00	105,562	1,344	24-hr Avg. (Upstream of Curtain):	43,535	(n=6)
9/1/15 2:00	18,498	316	24-hr Avg. (Below Iron Gate Dam):	551	(n=6)
9/1/15 6:00	10,148	150	% Reduction of 24-hr Avg.:	99%	
9/1/15 10:00		0			
9/1/15 14:00		0			
9/1/15 18:00		0			
			24-hr Summary:		
9/1/15 22:00		1,382	24-Hr Avg. (Upstream of Curtain):	n/a	
9/2/15 2:00		671	24-hr Avg. (Below Iron Gate Dam):	349	(n=6)
9/2/15 6:00		42	% Reduction of 24-hr Avg.:	n/a	
9/2/15 10:00	24,600	114			
9/2/15 14:00	31,570	787			
9/2/15 18:00	47,061	4,349			
			24-hr Summary:		
9/2/15 22:00	71,264	2,339	24-hr Avg. (Upstream of Curtain):	43,341	(n=6)
9/3/15 2:00	34,649	8,080	24-hr Avg. (Below Iron Gate Dam):	3,249	(n=6)
9/3/15 6:00	50,901	3,827	% Reduction of 24-hr Avg.:	93%	
9/3/15 10:00	77,627	130			
9/3/15 14:00	53,483	969			
9/3/15 18:00	102,683	852			
			24-hr Summary:		
9/3/15 22:00	67,768	3,932	24-hr Avg. (Upstream of Curtain):	56,226	(n=6)
9/4/15 2:00	28,838	379	24-hr Avg. (Below Iron Gate Dam):	1,135	(n=6)
9/4/15 6:00	6,956	548	% Reduction of 24-hr Avg.:	98%	
9/4/15 10:00	12,695				
			72-hr Avg. (Upstream of Curtain):	47700.58	(n=18)
			72-hr Avg. (Below IG Dam):	1644.82	(n=18)
			% Reduction of 72-hr Avg.:	97%	

### 3.3.2.1.2 Chlorophyll-*a*

The samples taken by the autosamplers were also analyzed for chlorophyll-*a*. These results also show a similar trend as the microcystin results. The downstream samples generally contained less chlorophyll-*a* than the samples from upstream of the curtain (Figure 36). Reductions in chlorophyll-*a* from upstream of the curtain to the Klamath River below Iron Gate dam averaged 61 percent and ranged from 1 to 89 percent.

Some of the samples from downstream of Iron Gate dam had inconsistently high concentrations of chlorophyll-*a*. The sample collected on 9/2/2015 at 18:00 was especially high in chlorophyll-*a*, but the samples from 9/1/2015 10:00 to 9/1/2015 22:00 also had higher than expected levels of chlorophyll-*a* (Figure 36; Table 4). Field crew notes identified that following the onset of the variable flow regime implemented by PacifiCorp on September 1 several pieces of filamentous macrophyte were found in several autosampler bottles. These larger pieces were physically removed from the sample bottles prior to analysis. Even with this removal, photos of sample filter pads suggest that the samples taken during these times contained large amounts of macrophyte/periphyton pieces that affected chlorophyll-*a* concentrations (Figure 37).

Experience has demonstrated that even small increases in flow can lead to sloughing of macrophytes, particularly in late summer when macrophytes are at maximum biomass. Subsequent flow variations on 9/3/2015 and 9/4/2015 did not bring about an increase in chlorophyll-*a* values, nor were macrophytes observed in autosampler bottles. This indicates that sloughing associated with higher flows occurred initially with the first flow increase pulse, but that flow increases in subsequent days resulted in little additional sloughing. The entire sequence of chlorophyll-*a* filters for below Iron Gate dam illustrate the notable increase not only in color on the filter, but also strands of macrophytes (Figure 37). These images also show how after a day or two of variable flows, the filters (and chlorophyll-*a* concentrations) return to approximately August 31, 2015 conditions (Figure 37, Table 4).

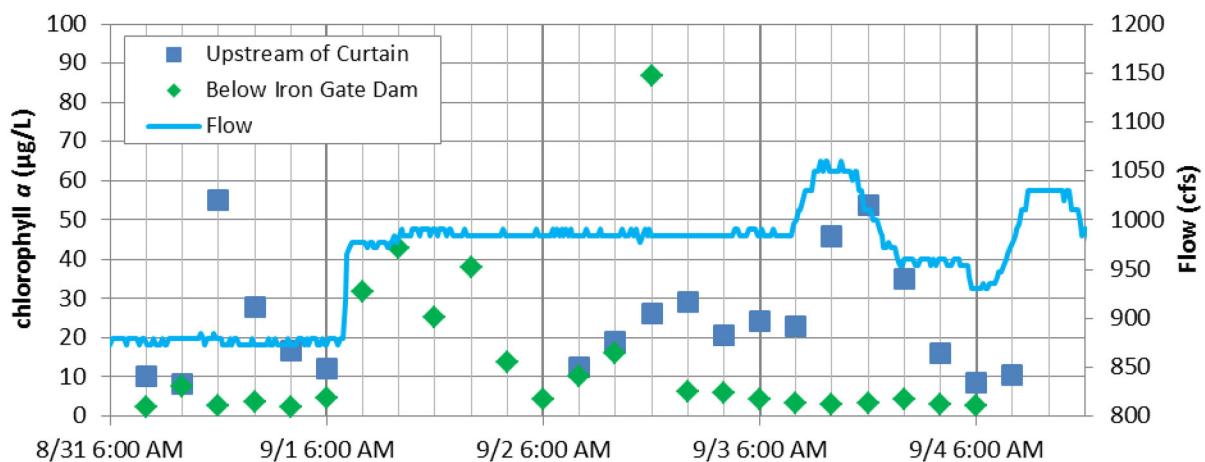

Figure 36. Chlorophyll-*a* data from Samples Collected Over a 96-hour Sampling Period Using Autosamplers Upstream of the Curtain in Iron Gate Reservoir and Below Iron Gate Dam in the Klamath River.

Samples were taken from a depth of 0.5 m. Klamath River flow downstream of Iron Gate dam (USGS Gage Number 11516530) is also presented (<http://waterdata.usgs.gov/ca/nwis>).

Table 4. Chlorophyll-*a* Data from Upstream of Curtain and Below Iron Gate Dam

Chlorophyll- <i>a</i> ( $\mu\text{g/l}$ )						
	Upstream of Curtain	Below Iron Gate Dam				
8/31/15 10:00	10.24	2.22				
8/31/15 14:00	8.32	7.61				
8/31/15 18:00	55.11	2.52				
8/31/15 22:00	27.99	3.63	24-hr Avg. Up	21.76	(n=6)	
9/1/15 2:00	16.79	2.27	24-hr Avg. Bel	3.81	(n=6)	
9/1/15 6:00	12.13	4.59	24-hr Avg. Reduction	83%		
9/1/15 10:00		31.67				
9/1/15 14:00		42.89				
9/1/15 18:00		25.22				
9/1/15 22:00		38.00	24-hr Avg. Up	n/a		
9/2/15 2:00		13.92	24-hr Avg. Bel	26.02	(n=6)	
9/2/15 6:00		4.41	24-hr Avg. Reduction	n/a		
9/2/15 10:00	12.33	10.26				
9/2/15 14:00	18.94	16.09				
9/2/15 18:00	26.36	86.87				
9/2/15 22:00	29.28	6.36	24-hr Avg. Up	21.93	(n=6)	
9/3/15 2:00	20.51	5.96	24-hr Avg. Bel	21.64	(n=6)	
9/3/15 6:00	24.18	4.28	24-hr Avg. Reduction	1%		
9/3/15 10:00	22.93	3.17				
9/3/15 14:00	45.75	2.85				
9/3/15 18:00	53.69	3.28				
9/3/15 22:00	34.97	4.11	24-hr Avg. Up	30.36	(n=6)	
9/4/15 2:00	16.18	2.95	24-hr Avg. Bel	3.19	(n=6)	
9/4/15 6:00	8.62	2.78	24-hr Avg. Reduction	89%		
9/4/15 10:00	10.60					
			96-hr Avg. Up	24.68	(n=18)	
			96-hr Avg. Bel	9.55	(n=18)	
			96-hr Avg. Reduction	61%		

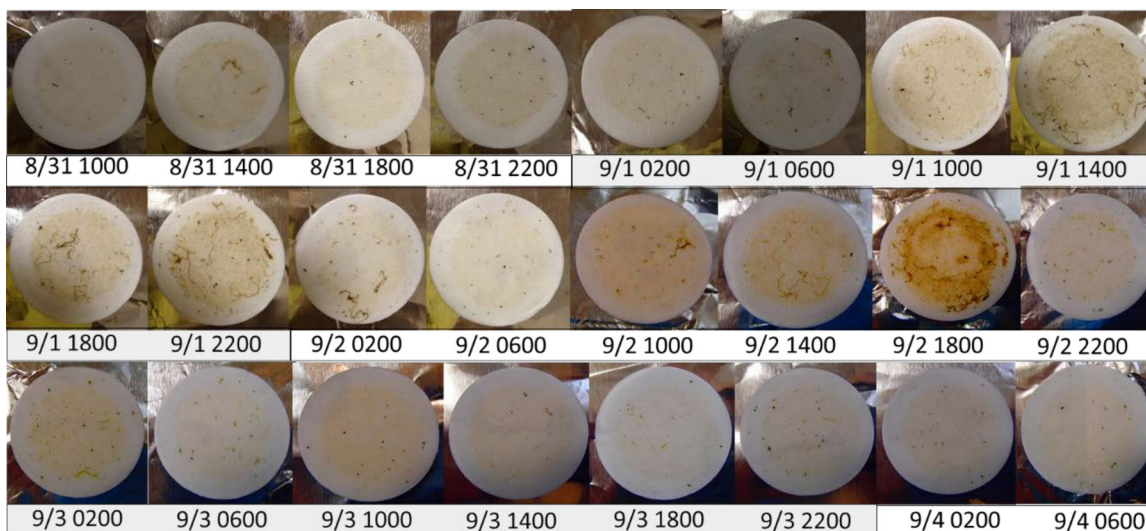

Figure 37. Photographs of Sequential Chlorophyll-*a* filters from the Autosampler Below Iron Gate Dam from August 31 to September 4, 2015.

### 3.3.3 Summary

Microcystin, algae species, and chlorophyll-*a* data from autosamplers located upstream of the curtain and downstream of Iron Gate dam showed that the curtain resulted in deeper waters being withdrawn from Iron Gate reservoir. In-reservoir data indicated that upstream of the curtain, algae species and chlorophyll-*a* showed sufficient variability to suggest that vertical movement of algae may play a role in diurnal conditions.

Comparing conditions in surface samples upstream of the curtain to conditions below Iron Gate dam indicates consistent reductions below Iron Gate dam, with average period reductions for microcystin, *Microcystis*, *Aphanizomenon*, and chlorophyll-*a* of 70, 82, 97, and 61 percent, respectively, when compared with upstream locations. The reduction in chlorophyll-*a* appeared to be impacted by the variable flow regime, which temporarily increased the macrophytes and corresponding chlorophyll-*a* levels in the downstream samples.

## 3.4 VERTICAL PROFILING UPSTREAM AND DOWNSTREAM OF CURTAIN

A set of vertical profiles were collected upstream and downstream of the curtain. The objective of this effort was to evaluate the effects of the curtain on microcystin, BGA species, chlorophyll-*a*, and physical water quality conditions from the surface to 15 m. These profiles allowed determination of notable vertical differences in individual constituents, especially microcystin and BGA.

### 3.4.1 Methodology

Two vertical profiles were completed on the morning of August 31, 2015. Each profile included grab samples at 3 m (9.8 ft) intervals from the surface to 15 m (49.2 ft) at the upstream and downstream BOB sites (Figure 3). The grab samples were analyzed for microcystin, chlorophyll-*a*, and algae speciation. Water temperature, dissolved oxygen, and pH data were also collected at each of these locations simultaneously with grab sample collection. At the time of sampling, the curtain was unfurled to its full depth of approximately 10.7 m (35 ft).

3.4.2 Results

Microcystin, BGA species, chlorophyll-*a*, and physical water quality, including water temperature, dissolved oxygen, and pH, were evaluated for each constituent.

3.4.2.1 Microcystin, Algae Species, Chlorophyll-*a*3.4.2.1.1 Microcystin

Microcystin concentrations varied from surface to depth in each profile. Microcystin concentrations upstream and downstream of the curtain diverged in shallower waters. Microcystin concentrations at five of the six depths were lower downstream of the curtain than at the upstream site (Figure 38). Samples upstream of the curtain in the first 6 m (19.7 ft) ranged from approximately 0.4 µg/L to over 1.1 µg/L. Downstream of the curtain all samples were consistently around 0.2 µg/L. At depths greater than 9 m (29.5 ft) or more, microcystin concentrations both upstream and downstream of the curtain were approximately equal at 0.2 to 0.3 µg/L – close to the reporting limit of 0.18 µg/L. The similar concentrations observed at depths of 9 m (29.5 ft) and greater indicates that water downstream of the curtain was drawn from deeper waters upstream of the curtain with lower microcystin concentrations.

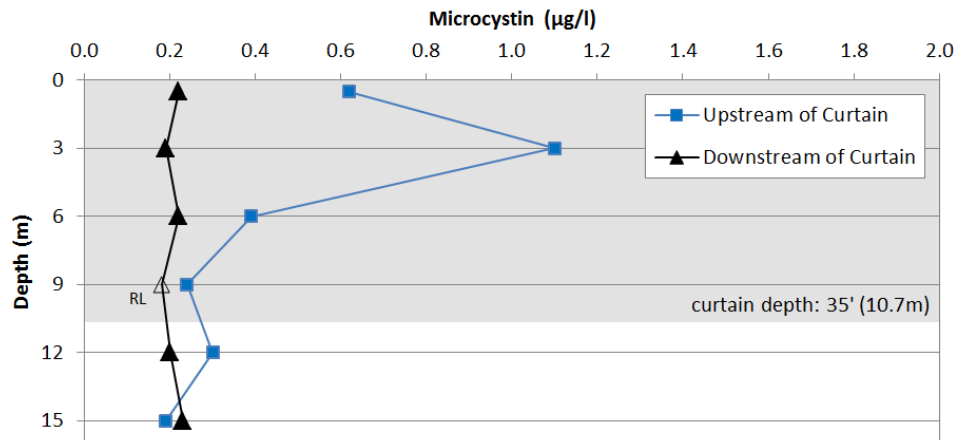

Figure 38. Microcystin Data from Samples Collected at Six Depths Upstream and Downstream of the Curtain on 8/31/2015 (RL=reporting limit at 0.18 µg/L).

3.4.2.1.2 Algae Species

*Microcystis* and *Aphanizomenon* were also enumerated for the two profiles. Both *Microcystis* and *Aphanizomenon* exhibited marked vertical variation upstream of the curtain, while both species were found at lower and similar concentrations throughout the water column downstream of the curtain (Figure 39 and Figure 40). Downstream *Microcystis* and *Aphanizomenon* concentrations throughout the water column were similar to upstream conditions for depths greater than 9 m (29.5 ft), suggesting that downstream waters are drawn from deeper waters upstream of the curtain.



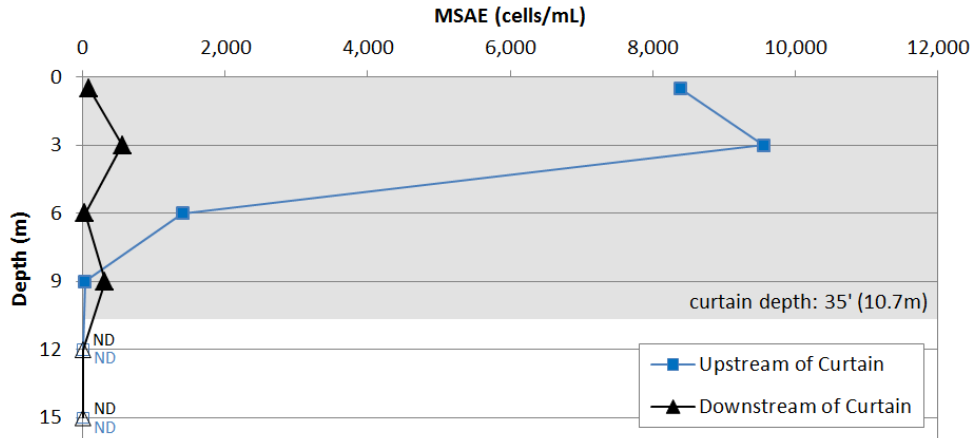

Figure 39. Comparison of *Microcystis aeruginosa* Cell Counts Upstream and Downstream of Curtain on 8/31/2015 (ND = nondetect).

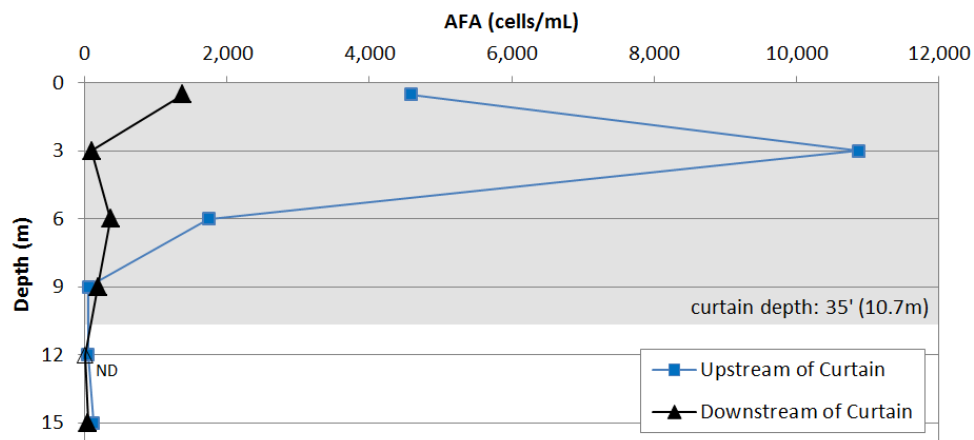

Figure 40. Comparison of *Aphanizomenon flos-aquae* Cell Counts Upstream and Downstream of Curtain on 8/31/2015 (ND=nondetect).

#### 3.4.2.1.3 Chlorophyll-a

Samples analyzed for chlorophyll-*a* exhibited similar trends as microcystin and BGA species. Chlorophyll-*a* concentrations upstream of the curtain exceeded 65  $\mu\text{g/L}$  in the top 3 m (9.8 ft) and concentrations in the deeper depths fell to 2  $\mu\text{g/L}$  or less. Downstream concentrations were all less than 2  $\mu\text{g/L}$  (Figure 41), similar to deeper waters upstream of the curtain.

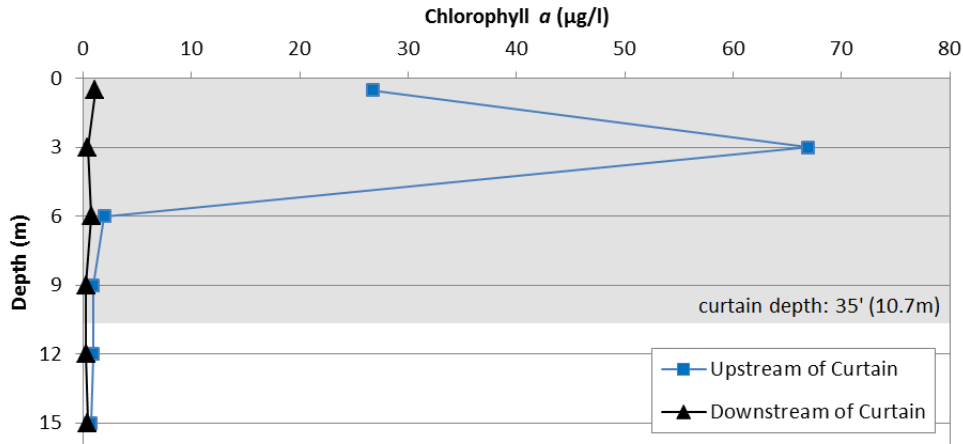

Figure 41. Comparison of Chlorophyll-a vertical Profiles Upstream and Downstream of Curtain on 8/31/2015.

### 3.4.2.2 Physical Parameters

Water temperature, dissolved oxygen, and pH data collected in profiles upstream and downstream of the curtain followed similar trends to the aforementioned constituents. Higher values were observed upstream of the curtain when compared to downstream of the curtain at depths less than 9 m (29.5 ft), but similar values upstream and downstream of the curtain were observed at depths greater than 9 m (29.5 ft). Water temperatures upstream of the curtain ranged from 18.4°C at depth to 22.2°C at the surface, while downstream of the curtain temperatures varied from 18.4°C at depth to approximately 20.9°C at the surface (Figure 42). Temperatures were approximately equivalent at depths of 12 m (34.4 ft) and deeper.

Dissolved oxygen concentrations upstream of the curtain varied from less than 1 mg/L at depth to approximately 9 mg/L at the surface, while downstream of the curtain values varied from less than 1 mg/L at depth to approximately 5 mg/L at the surface (Figure 43). Dissolved oxygen conditions were approximately equivalent at depths of 12 m (34.4 ft) and greater.

pH upstream of the curtain varied from 7 at depth to approximately 9.2 at the surface, while downstream of the curtain values varied from 7 at depth to approximately 8.3 at the surface (Figure 44). pH conditions were approximately equivalent at 12 m (34.4 ft) and greater.

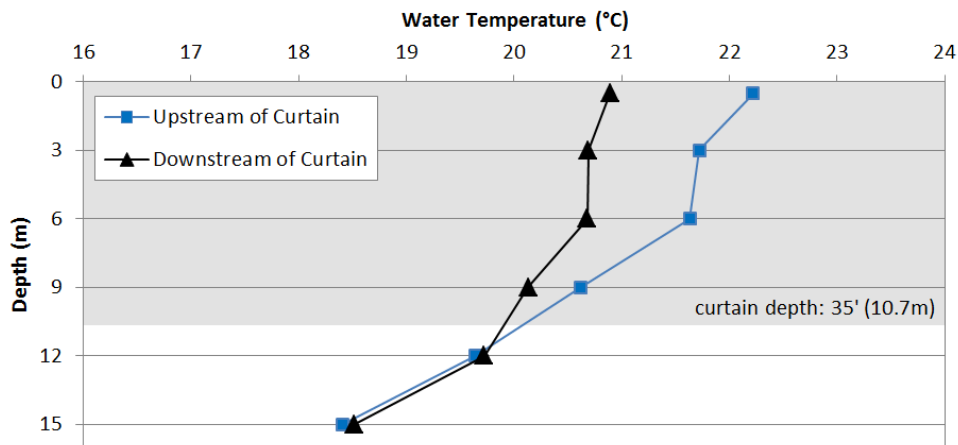

Figure 42. Vertical Water Temperature Profiles Upstream and Downstream of the Curtain on 8/31/2015.

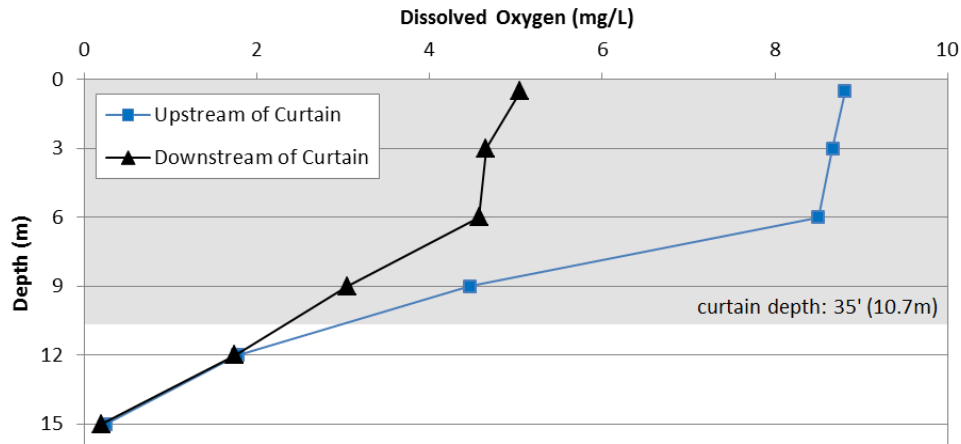

Figure 43. Vertical Dissolved Oxygen Profiles Upstream and Downstream of the Curtain on 8/31/2015.

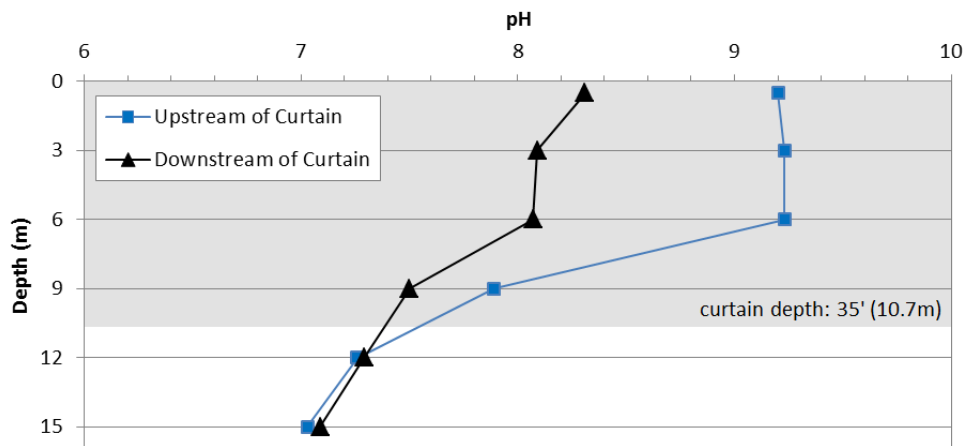

Figure 44. Vertical pH Profiles Upstream and Downstream of the Curtain on 8/31/2015.

### 3.4.3 Summary

The upstream and downstream vertical profiles indicate that the curtain isolated the upstream surface waters of Iron Gate reservoir. The vertical profiles of water temperature, dissolved oxygen, and pH upstream and downstream of the curtain generally followed a similar trend of declining values from the surface to bottom. The waters passing under the curtain are generally well mixed downstream of the curtain at these depths by locally higher velocity as waters head towards the intake tower. However, some vertical stratification of water downstream of the curtain is also apparent.

The profiles of water temperature, dissolved oxygen, and pH upstream of the curtain are indicative of the typical summertime vertical stratification that occurs in Iron Gate reservoir. The profiles of these parameters downstream of the curtain also show some vertical stratification, but appreciably less than upstream. This lesser level of stratification indicates that the area downstream of the curtain is not completely vertically mixed. This is likely a function of other external factors that act on waters in this region. Extensive macrophyte growth was also observed in the shallow regions downstream of the curtain and it is possible that these macrophytes contributed to dissolved oxygen and pH changes in this relatively small area.

### 3.5 ACOUSTIC DOPPLER CURRENT PROFILING

An ADCP was used to monitor water column velocities along both sides of the curtain. The objective of the ADCP study was to measure water velocity and direction as it approached the curtain and conditions downstream of the curtain. These data were intended to identify whether the curtain effectively segregated surface waters upstream of the curtain. The methods and results of the ADCP study are described below.

#### 3.5.1 Methodology

The ADCP system used for this study was a RiverRay ADCP (manufactured by Teledyne RD Instruments), float, and cables (Figure 45). The typical ADCP unit is designed to measure real-time current profiles while mounted on a floating vessel. The RiverRay system utilizes a collapsible trimaran float. The unit that was used in this study also had a Hemisphere R130-RTK GPS mounted above the ADCP to collect precise location data.

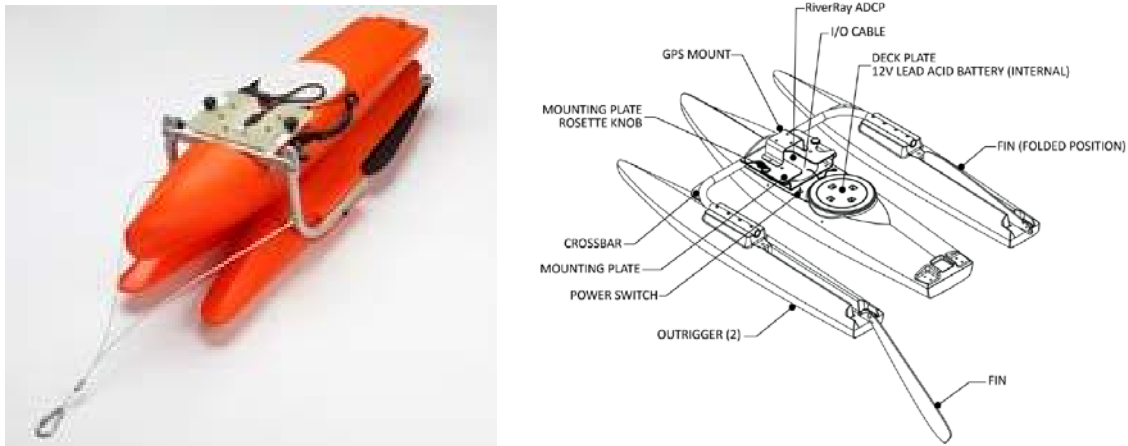

Figure 45. Photo and Schematic Overview of the Components of the RiverRay ADCP System.

Note: The ADCP transducer is housed within the center float of the trimaran. (Source: [http://www.rdinstruments.com/riverray.aspx#app\\_notes](http://www.rdinstruments.com/riverray.aspx#app_notes).)

The ADCP operates by transmitting sound waves at fixed intervals into the water column. These sound waves are reflected from suspended particles in the water column. The signals produced by these reflections are read by the ADCP. As particles move with the current, there is a change in frequency between the transmitted sound wave and the reflected sound wave. The ADCP calculates water velocity, current direction, and the depth within the water column based on this change in frequency and the timing of the returned echoes (Albertson 2009).

Current profile data are collected as the ADCP is towed along the water surface by a boat (Figure 46 and Figure 47). Multiple passes along a cross-section are typically conducted to ensure data consistency.

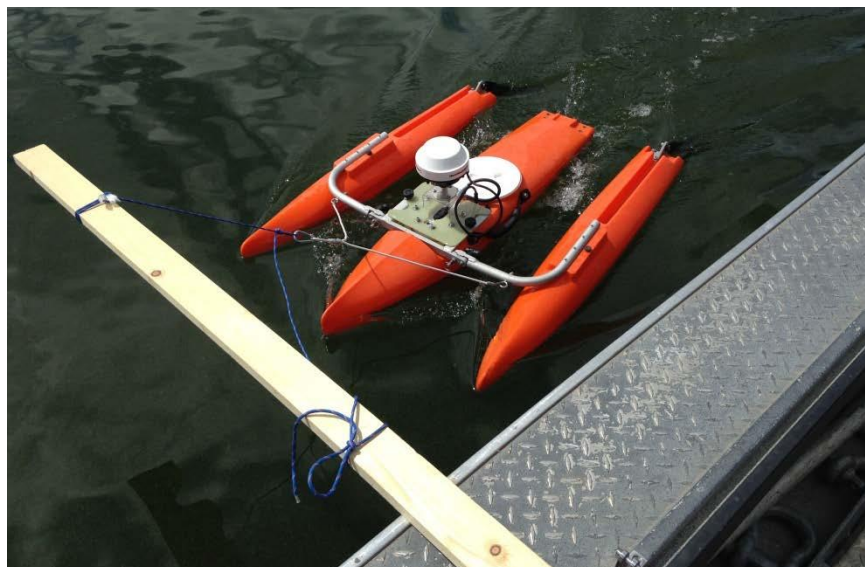

Figure 46. Acoustic Doppler Current Profiler Field Deployment.



Figure 47. Acoustic Doppler Current Profiler Transect Measurement Along the Curtain in Iron Gate Reservoir in August 2015.

ADCP transect measurements were conducted in Iron Gate reservoir to evaluate the current profile in the vicinity of the curtain. A transect consisted of traveling from one bank to another while the ADCP measured instantaneous data. Three transects were taken upstream of the curtain, and two were taken downstream of the curtain (Figure 48). These transect locations were selected to provide current profile information in the vicinity of the curtain.

All transects were performed parallel to the curtain and only differ from one another in the distance from the curtain (Figure 48). Transect 1 was 45 m (148 ft) upstream of the curtain and north of the upstream BOB. Transect 2 was 25 m (82 ft) upstream of the curtain, between the upstream BOB and the upstream buoys. Transect 3 was 5 m (16 ft) upstream of the curtain, between the upstream buoys and the curtain. Transects 4 and 5 were located downstream of the curtain. Transect 4 was 5 m (16 ft) downstream of the

curtain, between the curtain and the downstream buoys. Transect 5 was 25 m (82 ft) downstream of the curtain, between the downstream buoys and the downstream BOB.

The buoys and the BOB were used as landmarks when current profile measurements were taken along each transect. The boat speed for each transect was less than 1.0 meters per second (m/s) (3.3 feet per second [ft/s]). Each transect was repeated four times (i.e., four passes per transect) to ensure consistency. Review of these multiple passes indicated that the data were consistent and therefore, for clarity, only data from one representative transect at each location are presented.

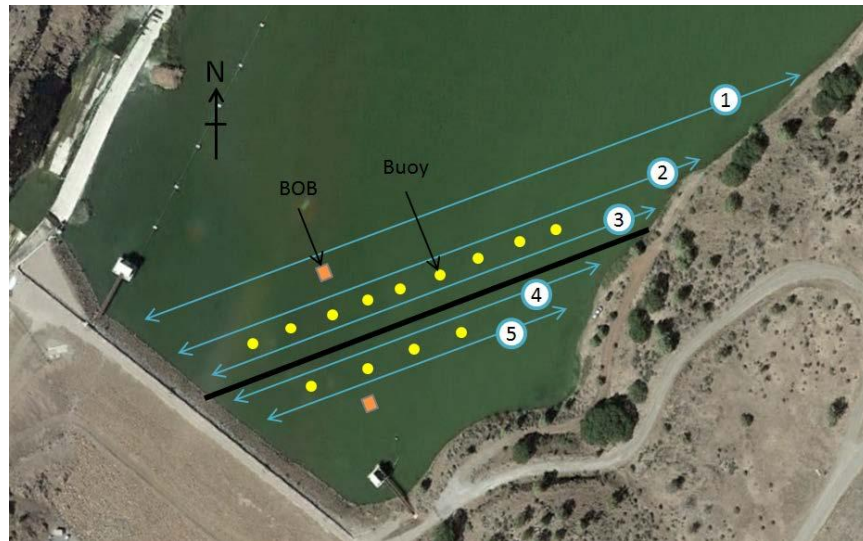

Figure 48. Schematic Showing the Approximate Locations of ADCP Transects Relative to the Curtain, Buoys, and the BOB.

### 3.5.2 Results

Placement of the curtain upstream of the intake tower was expected to alter the flow patterns in the area upstream of the Iron Gate Intake tower. The analysis of the ADCP results focused on quantifying flow patterns upstream and downstream of the curtain and relied upon velocity direction and magnitude data. For consistency, this discussion defines water moving towards the intake tower (i.e., southwards) as having negative velocity values and water moving away from the intake tower (i.e., northwards) as having positive velocity values. Because of interference generated by solid boundaries (the reservoir bottom for example), the ADCP does not consistently provide a clear signal near the reservoir bottom. While the actual reservoir bottom is represented by a heavy black line in the following figures, the thin black line (above the actual reservoir bottom) indicates the extent to which the ADCP is able to produce reliable velocity data.

Approximate curtain depth has been included in each figure for reference. The x-axis represents length in feet, and although ADCP readings were taken continuously from one transect measurement to the next, each transect is a different length, so scales vary and represent the relative distances along the transect. Further, because multiple transects were completed, transect graphs alternate right-left orientation of the dam (west) and the beach (east). Lastly, “Ref: BT” in the x-axis label refers to the ADCP bottom tracking capability that is used to determine the true velocity of water (with respect to the bottom).

At Transect 1, the most upstream transect, velocities were generally low throughout much of the cross-section (Figure 49). However, there was a discernible difference in velocity magnitude in the region

around 10 m (33 ft), a depth that corresponded to the bottom of the curtain. Specifically, a band of higher velocities of approximately 0.06 m/s (0.2 ft/s) occurs across the entire transect at this depth.

Similar conditions occur at Transect 2 and Transect 3 (Figure 50 and Figure 51). Upstream of the curtain at these two transects velocities are at or near zero, and those velocities that are not zero are positive, indicating flow was directed northwards, away from the curtain. While the data illustrate heterogeneity in velocity magnitude and direction, the consistent pattern shows that velocity is low in near-surface waters and relatively higher velocities oriented toward the intake tower are observed under the curtain at a depth of approximately 10 m (33 ft).

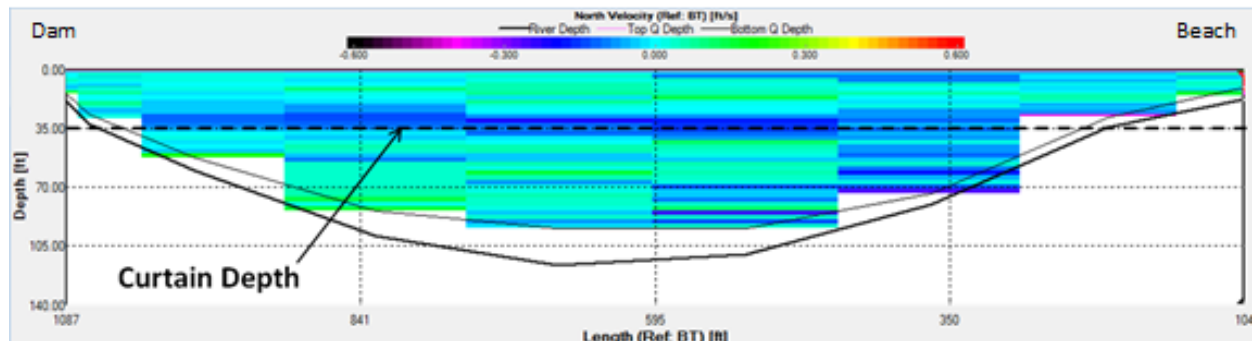

Figure 49. Representative Contour Map of the Magnitude of Current Velocities in the North-South Direction at Transect Location 1.

Negative values are movement southward toward the intake; positive values are movement northward away from the intake.

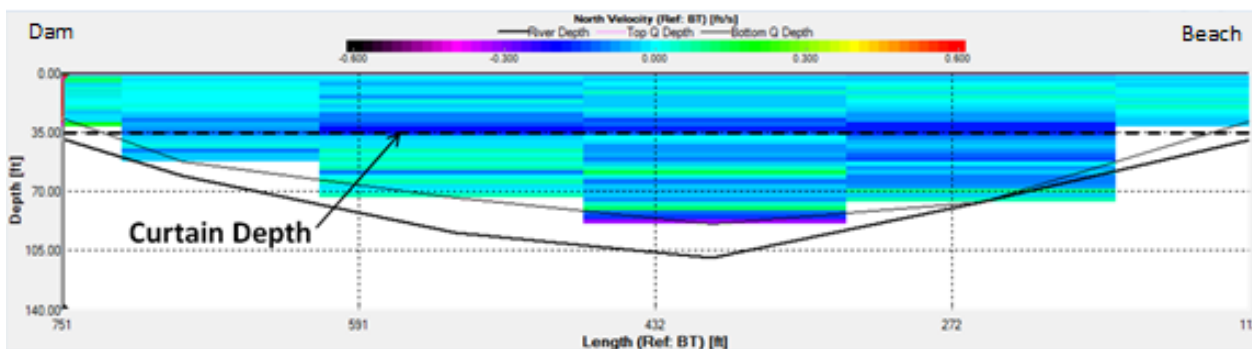

Figure 50. Representative Contour Map of the Magnitude of Current Velocities in the North-South Direction at Transect Location 2.

Negative values are movement southward toward the intake; positive values are movement northward away from the intake.

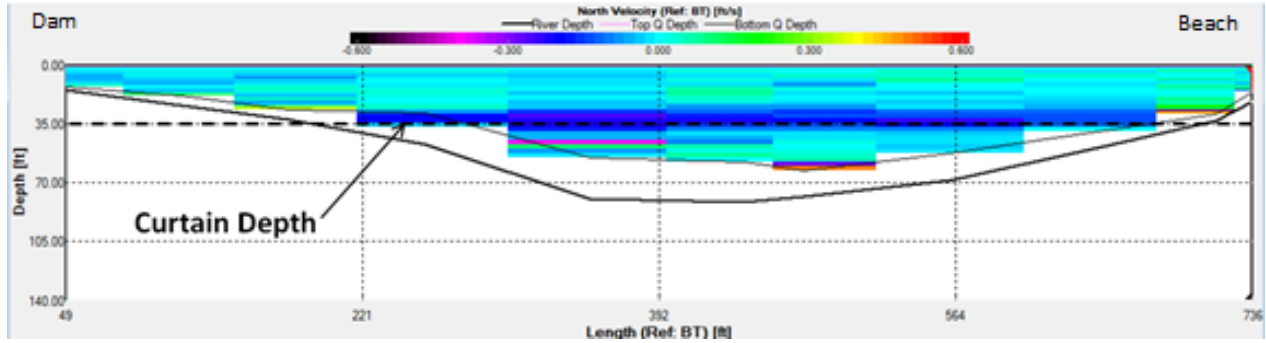

Figure 51. Representative Contour Map of the Magnitude of Current Velocities in the North-South Direction at Transect Location 3.

Negative values are movement southward toward the intake; positive values are movement northward away from the intake.

Examining vertical velocity profiles at the approximate mid-point of each of the three upstream transects illustrates an envelope of relatively higher water velocities that extended through the three transects (Figure 52). This flow envelope is a consequence of the curtain and is consistent with the thermal stratification pattern in the water column (Figure 42).

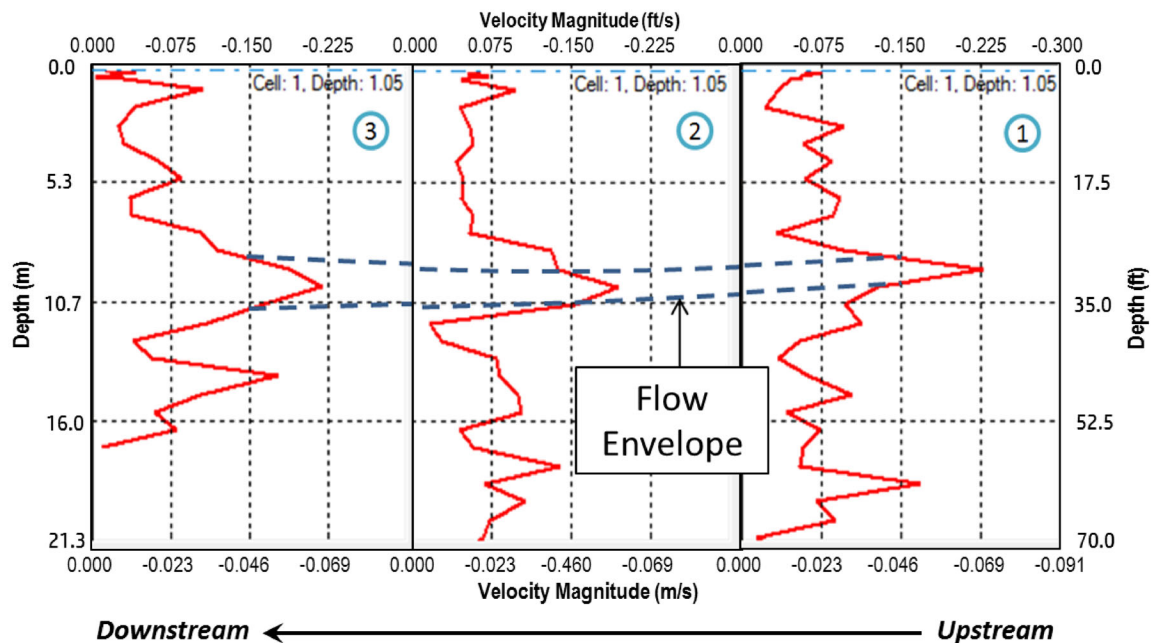

Figure 52. Velocity Profiles at Transect Locations 1, 2 and 3, Taken from the Center of the Three Transects Upstream of the Curtain.

A flow envelope has been superimposed on the figures for illustrative purposes.

Water velocities downstream of the curtain differ from those upstream of the curtain. Though velocity direction continued to be southwards towards the intake tower, higher velocities were distributed throughout a larger portion of the vertical profiles (Figure 53). In contrast to observations upstream of the curtain, near-surface waters showed high velocities heading to the intake and there was no segregation in velocities between the surface waters and deeper waters. As waters passed under the curtain and moved towards the intake tower, the reservoir cross section became narrower and overall reservoir depth was



shallower. These transects illustrated that near-shore areas experienced slower velocities since they were further away from the preferential flow path under the curtain directly to the intake tower and perhaps in response bed roughness (including that generated by macrophytes) in near-shore areas.

### 3.5.3 Summary

The principal finding from ADCP water velocity measurements collected in the vicinity of the curtain is that water downstream of the curtain largely originates from deeper reservoir water drawn under the curtain from upstream. This finding verifies that the curtain segregates near-surface waters from deeper waters. This conclusion also is supported by the other water quality sampling included in this report (see Section 4.2).

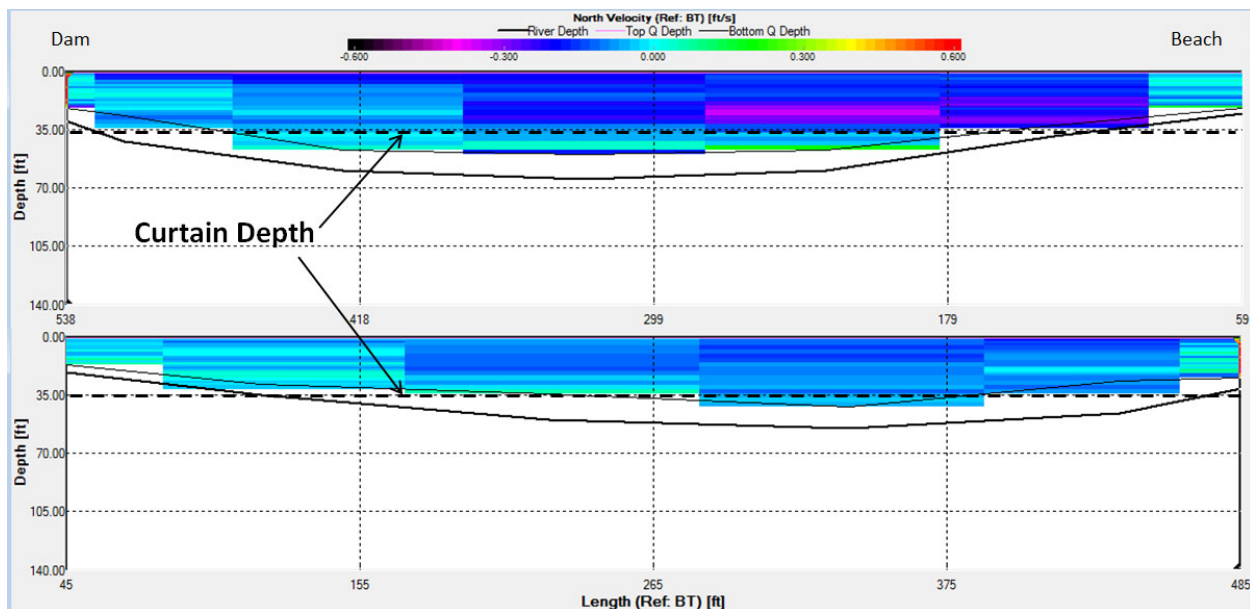

Figure 53. Representative Contour Maps of the Magnitude of Current Velocities in the North-South Direction at Transect Location 4 (top) and 5 (bottom).

Negative values are movement toward the intake; positive values are movement away from the intake.

## 3.6 PHYSICAL PARAMETER PROFILING DOWNSTREAM OF CURTAIN

To reduce the potential for BGA growth to occur downstream of the curtain, it is desirable that the relatively small reservoir volume downstream of the curtain be as completely-mixed as possible. To assess this condition, data were collected to examine the area downstream of the curtain for potential dead zones (areas of little water movement) that may accumulate and support growth of BGA. This task was completed through an extensive spatial set of vertical profiles.

### 3.6.1 Methodology

Water temperature, dissolved oxygen, and pH were measured using a YSI 6600 V2-4 multiparameter sonde at 15 locations downstream of the curtain. The sonde was also equipped with a YSI 6025 chlorophyll sensor reporting in  $\mu\text{g/L}$  (YSI 2016). This study was conducted on August 31, 2015, between approximately 2:30 pm and 4:15 pm. Readings were taken at 2-m intervals from the surface to 10 m or the 2-m interval closest to the bottom in areas shallower than 10 m.

### 3.6.2 Results

#### 3.6.2.1 Water Temperature

Water temperature data suggest that there was little temperature stratification within the area downstream of the curtain (Figure 54). The difference between the temperatures at the surface and at 10-m depths did not exceed 2.6°C. The location with the highest surface water temperature was close to shore where there was abundant macrophyte growth (Station 13, in Figure 54). The presence of macrophytes and the shallow depth may have impeded the amount of mixing in this area. The minor vertical variability in the temperature profiles, particularly in deeper portions of the surveyed area, was influenced by the presence of the curtain, which directs deeper waters from upstream of the curtain into this notably smaller area before it reaches the intake tower. The ADCP results indicated higher velocities in the deeper portions of this region behind the curtain, with lower velocities in shallow, near-shore areas (Figure 53).

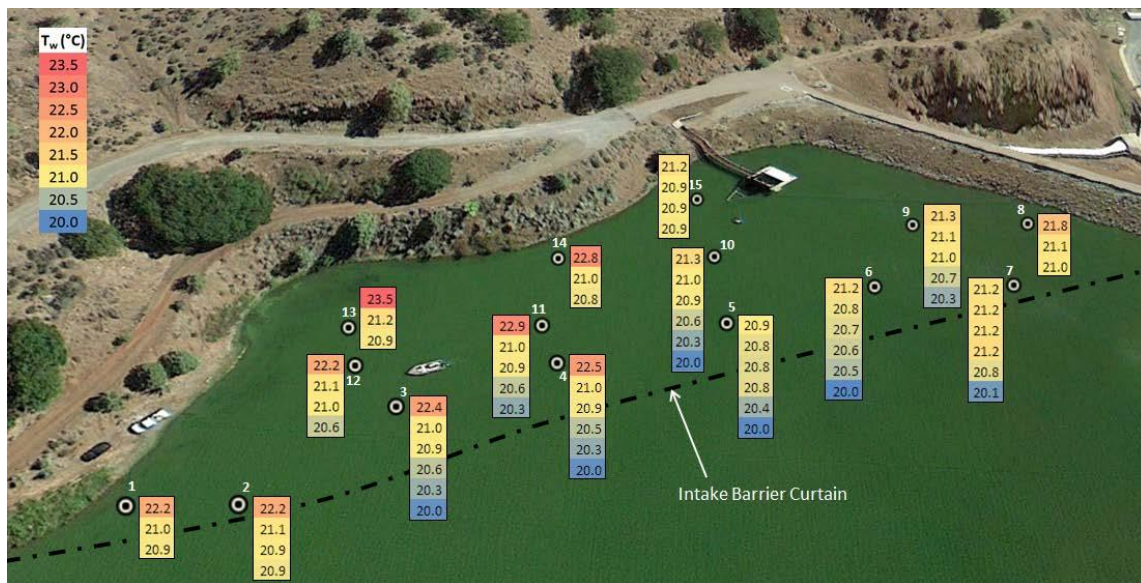

Figure 54. Vertical Profiles of Water Temperature at 15 Locations Downstream of the Barrier Curtain on 8/31/2015. Temperature (°C) readings were taken at the surface and every 2 m thereafter.

#### 3.6.2.2 Dissolved Oxygen

The differences in DO levels from surface readings to those at depth ranged from 0.6 to 5.2 mg/L (Figure 55). In general, smaller differences in DO were observed between the surface and depth at locations closer to the center of the curtain and in the direct flow path towards the intake tower (e.g., Stations 5, 6, 10, and 15). The greatest differences in DO levels were observed at stations where there was extensive macrophyte growth (e.g., Stations 1, 2, 12, and 13) and lower flow velocities. This greater difference in surface to depth DO at stations near the shore with lower flow velocities was likely in response to primary production that was occurring during the day of the monitoring.

#### 3.6.2.3 pH

pH values throughout the region downstream of the curtain were consistent with the observations of temperature and DO (Figure 56). Higher pH values occurred in near-surface waters versus those at depth, and those pH values in areas of extensive macrophyte growth were also elevated in response to primary production.

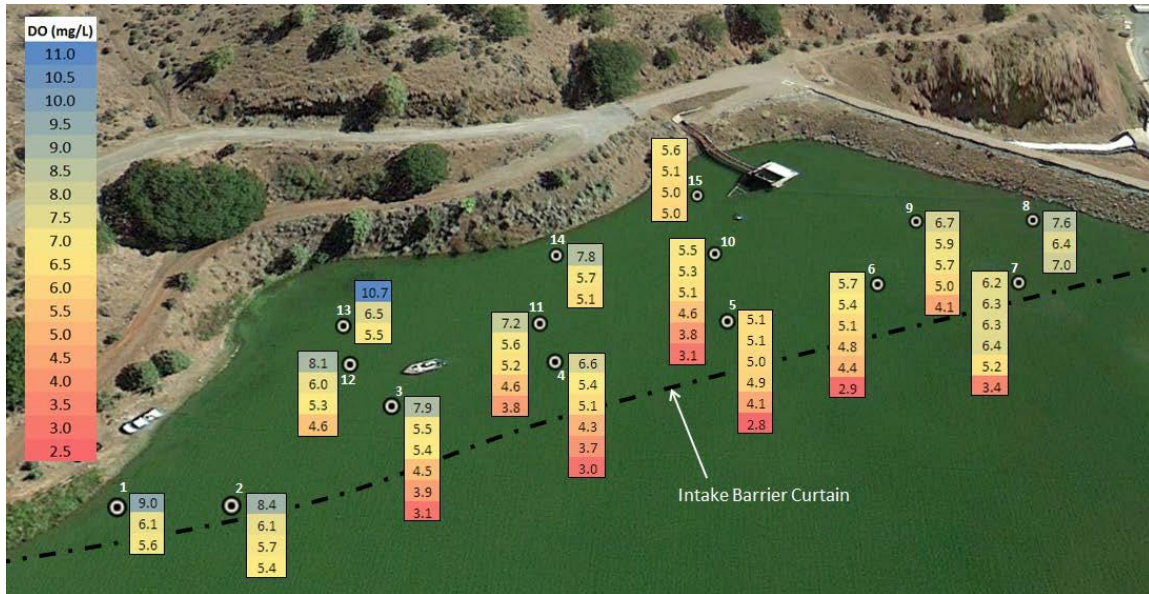

Figure 55. Vertical Profiles of Dissolved Oxygen at 15 Locations Downstream of the Barrier Curtain on 8/31/2015. Dissolved oxygen readings (mg/L) were taken at the surface and every 2 m thereafter.

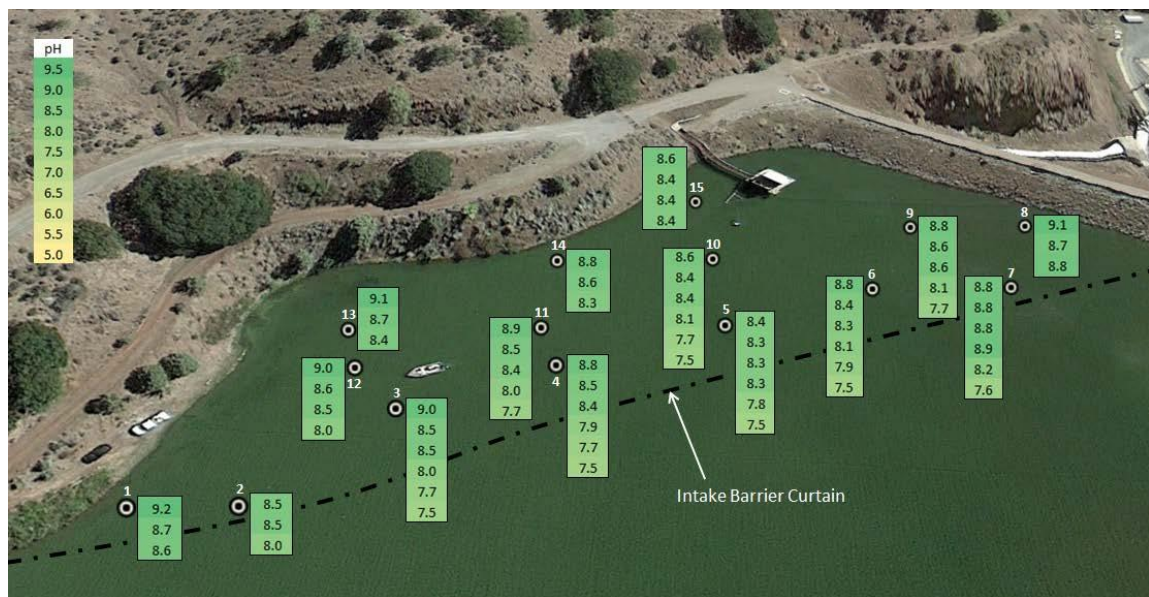

Figure 56. Vertical Profiles of pH at 15 Locations Downstream of the Barrier Curtain on 8/31/2015. Note: pH readings were taken at the surface and every 2 m thereafter.

### 3.6.2.4 Chlorophyll-a

Low levels of chlorophyll-a were observed throughout the various depths across the region (Figure 57). The highest values for chlorophyll-a were observed at station 1 where there was presumably little mixing of water and high levels of primary production. Overall, the chlorophyll-a data illustrated the

effectiveness of the curtain in reducing the conveyance of cyanobacteria from upstream of the curtain to downstream of the curtain.

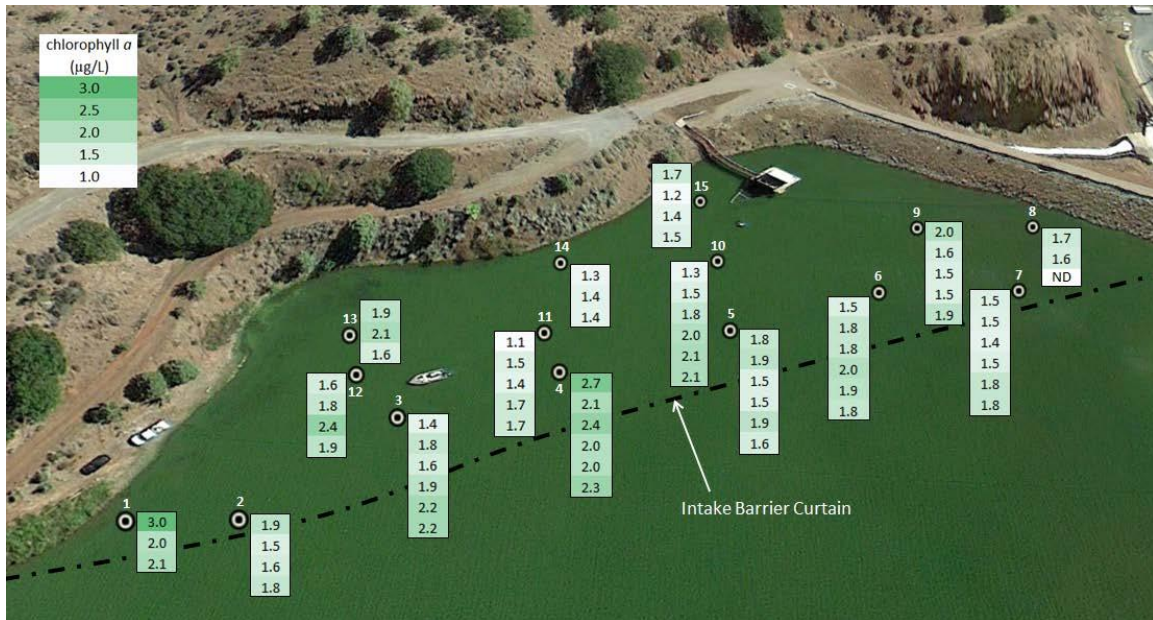

Figure 57. Vertical Profiles of Chlorophyll-a at 15 Locations Downstream of the Barrier Curtain on 8/31/2015. Chlorophyll-a (µg/L) readings were taken at the surface and every 2 m thereafter.

These vertical profiles provide a snapshot of the conditions downstream of the curtain, yet still provide insight into potential dead zone locations. Stations 1, 2, 12, and 13 all had elevated temperature, DO, and pH, in surface waters suggesting slightly longer residence times. This indicates a potential for primary production to increase downstream of the curtain in these areas. Interestingly, chlorophyll-a readings did not follow this trend, only indicating an elevated value at station 1. This is probably because chlorophyll-a measurements were based on water column phytoplankton and stations 1, 2, 12, and 13 were areas extensively colonized by macrophytes. Overall, the areas of limited mixing do not appear to be a large concern because they are small in relation to the overall area downstream of the curtain.

### 3.6.3 Summary

Vertical profiles collected downstream of the curtain provided additional data on conditions and insight into potential locations of dead zones (i.e., localized less-mixed areas) in the downstream area between the curtain and the dam. Data from a localized area in the eastern corner of the downstream area showed elevated water temperature, DO, and pH compared to the rest of the downstream area. As a result, this localized less-mixed area was suggestive of a longer hydraulic residence time in this area. Chlorophyll-a readings did not follow this trend, probably because chlorophyll-a measurements were based on water column phytoplankton. Overall, the localized less-mixed areas do not appear to be large enough to generate substantial amounts of BGA production in this small area downstream of the curtain.

## 4 POTENTIAL WIND EFFECTS

Reservoirs can be mixed by wind events that produce surface and internal waves. Surface waves are easily identifiable, but internal waves that occur within the reservoir (e.g., at the thermocline) are not so obvious. Internal waves, technically termed seiches, are most notable at the thermocline and can contribute to mixing (Horne and Goldman 1994). Wind mixing may affect curtain performance by mixing surface waters deeper into the reservoir, as well as creating internal waves; both of these may result in near-surface waters being mixed to depth and drawn under the curtain. Wind events are typically of short duration in the summer and early fall.

Local wind measurement data were reviewed to determine how wind may impact curtain performance. An assessment was completed to explore the potential for wind mixing in Iron Gate reservoir that considered local wind and reservoir conditions and curtain depth. The extent of mixing in Iron Gate reservoir was evaluated and quantified by calculating the Wedderburn number and estimating the extent to which the thermocline is affected by wind stresses (known as thermocline tilt). Methods for both avenues of investigation are outlined in Fischer et al. (1979).

### 4.1 WEDDERBURN NUMBER

The Wedderburn number is a dimensionless number that represents short-term mixing patterns in the epilimnion. Low values (0.01 to 1) indicate unstable conditions that translates to an isothermal or near isothermal state, whereas high values (>1) indicate higher stability in the epilimnion representative of weak or intermittent stratification. The Wedderburn number,  $W$ , is calculated as follows:

$$W = \frac{g'h^2}{u^2L}$$

where

- $g'$  = reduced gravitational acceleration due to the density difference across the epilimnion (meters per second squared [ $m/s^2$ ])
- $h$  = depth of the mixed water layer (m)
- $u$  = characteristic shear velocity (m/s)
- $L$  = fetch represented by the reservoir open water length in the direction of the wind (m)

Note that the characteristic shear velocity,  $u$  (m/s) is calculated as  $U(\rho_A/\rho_w)^{0.5}$  where  $U$  is wind speed (m/s),  $\rho_A$  is density of air (kilograms per cubic meter [ $kg/m^3$ ]), and  $\rho_w$  is density of water ( $kg/m^3$ ) (Fischer et al. 1979).

Reduced gravitational acceleration,  $g'$ , is a function of the density difference between the top and bottom layers of the epilimnion. These differences were derived from thermal profiles in the reservoir. Vertical temperature profile data collected at the Iron Gate reservoir log boom for 2010, 2011, and 2013 indicated that the epilimnion thickness of Iron Gate reservoir from July to September ranged between approximately 7 m to 15 m, and water temperatures typically ranged from 18 to 25°C (Figure 58).

#### 4 Potential Wind Effects

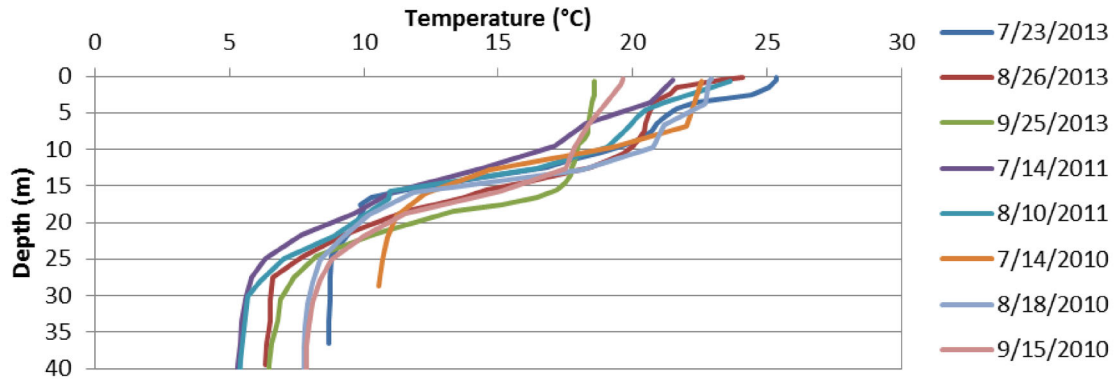

Figure 58. Vertical Temperature Profile Data at Iron Gate Reservoir Log Boom in 2010, 2011, and 2013.

The fetch for Iron Gate reservoir was assumed to be approximately 2,200 m, extending from near the dam upstream along the main body of the reservoir. Wind speed data from 2015 indicated that average wind speed during curtain deployment was 1.9 m/s, with a maximum of 8.5 m/s (Figure 59). Given these data, the Wedderburn number values for average and maximum wind speed during the 2015 field period at Iron Gate reservoir were calculated (Table 5).

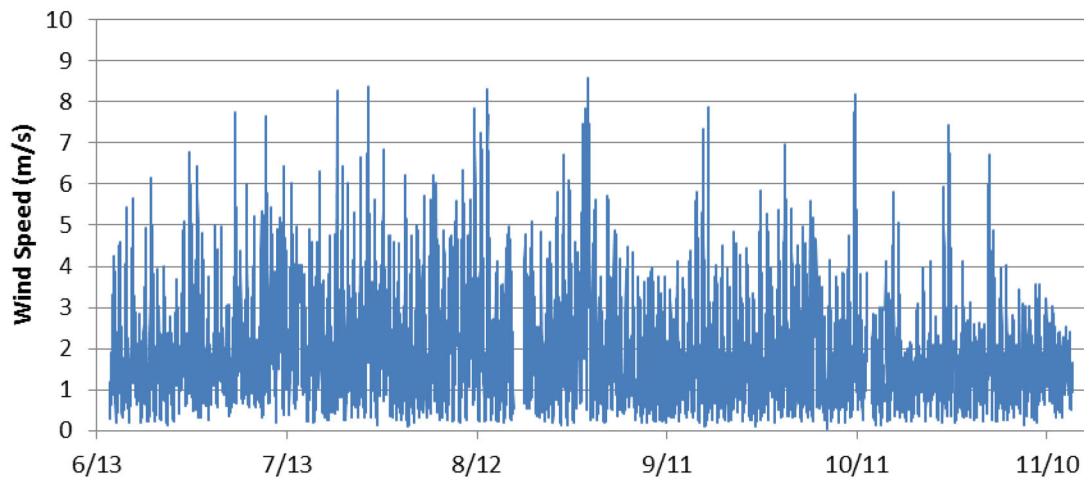

Figure 59. Wind Speed Data Collected from 6/15/2015 to 11/13/2015.

Table 5. Summary of Possible Range of Wedderburn Numbers for Iron Gate Reservoir Between July and September of 2015.

	Wind Speed		Epilimnion Depth*	Wedderburn Number
	m/s	mph	m	-
Average	1.9	4.2	7	6.9
			10	36.3
			15	70.0
Maximum	8.5	19.2	7	0.3
			10	1.5
			15	2.9

\* 7-m-deep epilimnion calculations were based on data from 7/14/2010, 10-m-deep epilimnion calculations were based on data from 8/26/2013, 15-m-deep epilimnion calculations were based on data from 9/25/2013 (see Figure 58).

The range of calculated Wedderburn numbers for the average wind speed for the three identified epilimnion depths is greater than 1.0 in all cases (Table 5). These findings suggest that in the summer months when the lake is stratified, weak or intermittent stratification within the epilimnion is the predominant condition. Weak or intermittent stratification may or may not persist throughout a 24-hour period, but is expected to occur frequently. This stratification would resist mixing from wind stresses on the surface of the reservoir generated by average wind speeds of 1.9 m/s. The maximum wind speed of 8.5 m/s that was recorded was an instantaneous peak wind event (not a continuous wind speed) and it is presented in this evaluation as a continuous wind speed to create a worst-case scenario. When winds of this velocity are applied to the surface of the reservoir, the Wedderburn numbers indicate that unstable conditions are created in the epilimnion only to the 7-m depth (Table 5). Once winds abate, the Wedderburn number would increase to above 1.0 and the reservoir epilimnion would stabilize and re-establish weak or intermittent stratification.

These calculations can also be used to assess the extent of vertical mixing in the epilimnion. Several calculations were completed for different epilimnion depths to determine the depth of mixing associated with a persistent 8.5-m/s wind. Based on these calculations, when epilimnion depth is 10 m or more, a persistent 8.5-m/s maximum wind would not mix to the full epilimnion depth. For the 7-m epilimnion depth, a persistent 8.5-m/s wind could mix to full depth of the epilimnion. Because the barrier curtain is approximately 10 m deep, wind mixing of the epilimnion is predicted to not result in epilimnion waters being entrained under the curtain.

#### 4.2 THERMOCLINE TILT

In addition to the calculation of Wedderburn numbers, the amount of tilt that the thermocline will undergo under internal seiching was also calculated. If the thermocline is offset sufficiently, water from the epilimnion could pass under the curtain, which could be detrimental to water quality downstream of the curtain. Thermocline tilt ( $\Delta h$ ) was calculated using the following equation:

$$\Delta h = \frac{L}{2R^*}$$

Where  $R^*$  is the Richardson number,

$$R^* = \frac{g''k^2}{u^2}$$

$g''$  = reduced gravitational acceleration due to the density difference across the base of the thermocline which is a function of water density difference between the epilimnion and the hypolimnion. (m/s<sup>2</sup>)

$k$  = depth of thermocline (m)

$u$  = characteristic shear velocity, based on wind speed (m/s)

$L$  = fetch (basin length in the direction of the wind) (m)

Gravitational acceleration,  $g''$ , used for calculating the Richardson number is not the same as the gravitational acceleration value,  $g'$ , used for calculating the Wedderburn number. The estimated thermocline tilt was calculated for the same three days (7/14/2010, 8/25/2013, and 9/25/2013) as the Wedderburn number because these profiles bracket the possible ranges of summer stratification (Table 6). The relevant parameter for calculating the Richardson number is the depth of the thermocline (Table 6).

Table 6. Summary of Possible Range of Richardson Number and Thermocline Tilt for Iron Gate Reservoir Between July and September.

	Wind Speed		Thermocline Depth *	Richardson Number	Thermocline Tilt
	m/s	mph	m	-	m
Average	1.9	4.2	10	48,516	0.02
			17	83,686	0.01
			18	64,402	0.02
Maximum	8.5	19.2	10	2,063	0.53
			17	3,559	0.31
			18	2,738	0.40

\* 10-m thermocline depth calculations were based on data from 7/14/2010, 17-m thermocline depth calculations were based on data from 8/26/2013, 18-m thermocline depth calculations were based on data from 9/25/2013.

The estimated thermocline tilt on a typical day (1.9 m/s wind speeds) did not exceed 0.02 m (Table 6). The worst-case scenario was 0.53 m, represented by a wind speed of 8.5 m/s and thermocline depth of 10 m. Even the worst-case condition was insufficient to offset the thermocline more than 1 m.

Overall, given typical meteorological conditions at Iron Gate reservoir, typical summer stratification conditions, local meteorological conditions, and a fully deployed curtain (10.7 m/35 ft), it is unlikely that wind events will generate enough thermocline tilt to allow water from the epilimnion to pass under the curtain. At shallower curtain depths (e.g., 3 m [10 ft]) and shallower thermoclines, wind-generated thermocline tilt could play a more predominant role in curtain performance.



## 5 CONCLUSIONS

An intake barrier curtain was installed in Iron Gate reservoir in 2015. The curtain was intended to segregate surface waters from the body of the reservoir and prevent those waters from being entrained into the powerhouse intake and released to the Klamath River downstream of Iron Gate dam. Detailed investigations in the summer of 2015 evaluated the water quality effects of the curtain. Investigation conclusions are summarized as follows:

- BGA, water temperature, and dissolved oxygen data indicated that the curtain resulted in deeper waters being withdrawn from Iron Gate reservoir. BGA (expressed as RFU) were reduced downstream of the curtain and in the Klamath River downstream of the dam. Water temperatures downstream of the curtain and downstream of Iron Gate dam were similar to temperatures of deeper waters upstream of the curtain. Dissolved oxygen downstream of the curtain was lower and reflected dissolved oxygen levels from deeper-water upstream of the curtain. Dissolved oxygen conditions downstream of Iron Gate dam were maintained at suitable levels as a result of turbine venting operations at the Iron Gate powerhouse and natural reaeration.
- Microcystin, algae species, and chlorophyll-*a* data indicated that the curtain resulted in deeper waters being withdrawn from Iron Gate reservoir. Consistent reductions in all of these constituents were observed below Iron Gate dam when compared to data from surface samples collected upstream of the curtain. Average reductions for microcystin, *Microcystis*, *Aphanizomenon*, and chlorophyll-*a* from surface samples (0.5 m) were 70, 82, 97, and 61 percent, respectively.
- Water velocities upstream of the curtain were at or near zero in the shallow near-surface waters and substantially higher at a depth representative of the bottom of the curtain. These velocities indicate the curtain was successful at reducing entrainment from shallow areas and that water passing under the curtain is drawn from a narrow envelop that extends slightly above and beneath the curtain bottom. Downstream of the curtain, velocities were more uniformly distributed at different depths in response to waters flowing under the curtain into a relatively small-volume area where the reservoir cross-section becomes progressively narrower and shallower as it nears the intake tower.
- Vertical profiles collected downstream of the curtain provided additional data on conditions and insight into potential locations of dead zones. Data from an area in the eastern corner downstream of the curtain that showed elevated temperature, DO, and pH were suggestive of longer residence times in this area. Chlorophyll-*a* readings did not follow this trend, probably because chlorophyll-*a* measurements were based on water column phytoplankton. Overall, the dead zones do not appear to be large enough to generate substantial amounts of BGA production in this small area downstream of the curtain.
- Given the typical meteorological conditions at Iron Gate reservoir and summer stratification conditions, wind events will not adversely impact curtain performance. Winds at Iron Gate reservoir are unlikely to mix the epilimnion or create internal thermocline tilt such that epilimnion waters would be drawn under the curtain.

Overall, the curtain was effective at isolating near-surface waters upstream of the curtain. Water quality samples, physical measurements, velocity profiles, and field observations of conditions consistently identified that waters of the photic zone, where the majority of BGA occur, were largely isolated to the upstream side of the curtain. Using temperature as a surrogate, the curtain isolated near-surface waters upstream of the curtain in the body of Iron Gate reservoir, thereby capturing the majority of the water column where BGA occur (Figure 60). Waters that ultimately pass under the curtain are drawn from

## 5 Conclusions

deeper regions of Iron Gate reservoir upstream of the curtain with lower concentrations of algae and associated algal toxins.

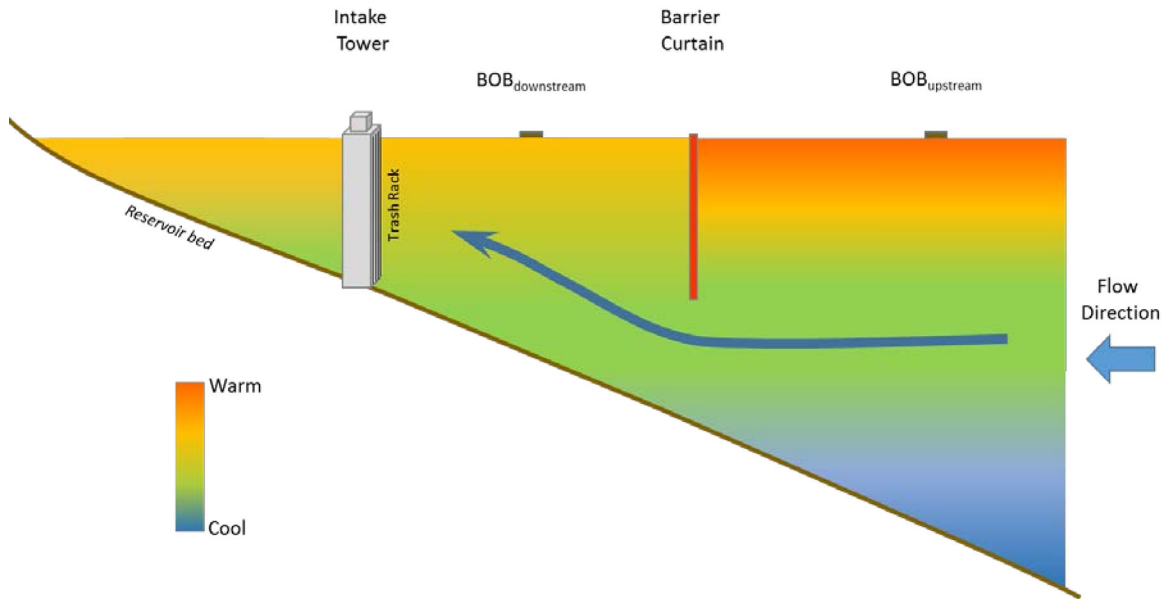

Figure 60. Conceptual Profile View of Thermal Conditions in Iron Gate Reservoir Showing the Location of the BOBs, Curtain, and Intake Tower.

## 6 REFERENCES

- Albertson, S. 2009. Standard Operating Procedures for Calibration, Preparation, and Deployment of Teledyne RD Instruments Acoustic Doppler Current Profilers (ADCPs) © (RDI). Version 1.0. Washington State Department of Ecology Environmental Assessment Program.  
[http://www.ecy.wa.gov/programs/eap/qa/docs/ECY\\_EAP\\_SOP\\_ADCP\\_v1\\_0EAP050.pdf](http://www.ecy.wa.gov/programs/eap/qa/docs/ECY_EAP_SOP_ADCP_v1_0EAP050.pdf)
- Fischer, H.B., E.J. List, R.C.Y. Koh, J. Imberger, and N.H. Brooks. 1979. Mixing in Inland and Coastal Waters. Academic Press, New York, NY.
- Horne, A. J. and C.R. Goldman. 1994. Limnology. McGraw Hill, New York. 576 pp.
- Moisander, P. 2008. Presentation to the Klamath Blue-Green Algae Work Group (Sacramento) - Diversity and nutrient limitation of *Microcystis* in Klamath River reservoirs. University of California Santa Cruz, Ocean Sciences Department.
- State Water Resources Control Board. 2010. Cyanobacteria in California Recreational Water Bodies: Providing Voluntary Guidance about Harmful Algal Blooms, Their Monitoring, and Public Notification. Blue Green Algae Work Group of the State Water Resources Control Board (SWRCB), the California Department of Public Health (CDPH), and Office of Environmental Health and Hazard Assessment (OEHHA). Sacramento, CA. June.
- YSI. 2016. YSI Chlorophyll Sensor—Measure Chlorophyll Fluorescence with a Self-cleaning Sensor. Accessed May 2016.  
<https://www.ysi.com/File%20Library/Documents/Specification%20Sheets/E39-6025-Chlorophyll-Sensor.pdf>