

State of California
The Resources Agency
DEPARTMENT OF WATER RESOURCES
Office of SWP Planning

Modeling Flow-Salinity Relationships in the Sacramento-San Joaquin Delta Using Artificial Neural Networks

February 1999

Program Manager
Francis Chung

Staff
Nicky Sandhu
Don Wilson
Ralph Finch

Technical Information Record OSP-99-1

This TIR is primarily a working paper and is subject to revision or replacement.

Table of Contents

Introduction	1
Chapter 1 - Modeling Flow-Salinity Relationships in the Sacramento-San Joaquin Delta Using Artificial Neural Networks	3
Background	3
Development of ANN Model	6
SAC Flow Estimation Methodology	8
Discussion of Results	9
Marginal Export Cost Calculations	13
Future Directions	14
References	15
Chapter 2 - Historic Correlations and ANN Development	17
Chapter 3 - Marginal Export Cost (MEC) Estimates Using ANNs	19
Figures	23

i Introduction

This report documents the methodology of developing Artificial Neural Networks to estimate salinity in the Sacramento-San Joaquin Delta. Once trained, these Artificial Neural Networks are capable of quickly estimating salinity for selected locations within the Delta.

Chapter 1 comprehensively describes the process of developing and using Artificial Neural Networks (ANNs) to model Delta salinity. This chapter also describes a concept known as Marginal Export Cost (MEC) and goes on to describe how ANNs can be used to estimate MEC.

Chapter 2 describes how ANN performance can be hindered by correlations between inputs. This second chapter then proposes a solution designed to reduce the adverse effects of historic correlations and then implements this solution.

Chapter 3 presents two case studies where Marginal Export Cost is estimated using Artificial Neural Networks. The first case estimates the MEC attributable to a constant, long-term 500 cfs reduction in pumping, while the second case estimates the MEC attributable to pumping required for the 1991 Drought Water Bank.

1 Modeling Flow-Salinity Relationships in the Sacramento-San Joaquin Delta Using Artificial Neural Networks

BACKGROUND

Description of the Delta

The Sacramento-San Joaquin Delta is a unique and valuable resource and an integral part of California's water supply network. Figure 1-1 displays a map of the Delta. Runoff from 40 percent of the State's land drains into the Delta from the Sacramento, San Joaquin, and other rivers. Water projects divert water from the Delta to meet the needs of about two-thirds of the State's population. Export facilities include California's State Water Project, the U.S. Bureau of Reclamation's Central Valley Project, Contra Costa Canal, and the North Bay Aqueduct. In addition to these exports, there are about 1,800 local irrigation diversions located within the Delta. Most of the remaining water, which is the Net Delta Outflow (NDO), flows into the San Francisco Bay. Saline water from Suisun Marsh and San Francisco Bay is normally kept from intruding into the Delta by these freshwater outflows. There is a complex relationship between freshwater inflows, exports, barrier configurations and the salinity distribution within the Delta.

Description of the Problem

Salinity in the Delta is a function of many factors such as river inflows, exports through pumping, and barrier (gate) operations. Other factors influencing salinity are tides, agricultural activities, wind, and barometric pressure.

To simplify the model, salinity is initially considered to be a function of only flows (inflows, exports, and channel depletions). The problem is then to estimate salinity, given the flow conditions, with speed and accuracy. Such a model could then be used to estimate inflows required to keep the level of salinity below a certain predefined regulatory level by controlling flow, one of the factors influencing salinity in the Delta.

The Department of Water Resources currently uses a numerical simulation model DSM2 to simulate salinity as a function of various pumping scenarios, upstream flows, and barrier configurations.

Definition of Marginal Export Cost (MEC)

Marginal Export Cost (MEC) is defined as the extra water needed to carry a unit of water across the Delta to the pumping plants for exports while maintaining a constant salinity at a given location. Or more practically, when the exports are increased by one unit, the Sacramento River flow has to be increased by one unit plus marginal export cost to maintain a constant salinity at a given location in the Delta.

MEC can further be defined to be calculated for two different situations. Transient Impulse MEC (TIMEC) can be defined as the MEC for a sudden perturbation in pumping of the order of one

month. Continuous Impulse MEC (CIMEC) is the MEC for increased pumping levels over longer periods of time of the order of three months or more. These two types of requirements are different in magnitude with TIMEC being greater than CIMEC. For practical purposes the actual MEC probably lies between TIMEC and CIMEC and closer to CIMEC.

Goal of Modeling

There is a need for a fast and accurate method of modeling the relationship between flows and salinity in the Delta. Also, a model is required to simulate salinity under different flows for optimization of reservoir releases, real-time control of operation of pumping plants, and so on.

Such a model would then be able to accurately estimate Sacramento River flow given other hydrologic conditions and salinity standards. MEC estimates could also be made from such a model.

The California Department of Water Resources Planning and Simulation Model (DWRSIM, California 1994) is a monthly time step, reservoir system simulation model of California's Central Valley. The Sacramento River flow required to keep the salinity below specifications is a constraint on DWRSIM. A sub-model, called MDO (Minimum Delta Outflow), is used for purposes of predicting outflows sufficient for meeting the environmental constraints imposed by the maximum allowable salinity levels. One of the goals of this current modelling effort would be to replace MDO with an improved model.

Previous Work

Past attempts at estimating MEC have had limitations. An attempt was made to estimate MEC directly using historical data identifying a period of time when Net Delta Outflow (NDO) was fairly constant, but Sacramento River flow and exports were increasing. If MEC existed, salinity at interior Delta stations should have increased.

While there are a few periods when this seems to be true, the salinity increase can also be explained by antecedent conditions. That is, previous to the period of constant NDO, NDO was much higher and the salinity increase could be simply due to the Delta gradually reaching a new equilibrium. Thus it became apparent that only a model of the Delta could give more insight into MEC.

MDO is one such model that estimates the minimum required Delta outflow given the salinity requirement. MDO was found to be lacking in correctly estimating the required Delta outflow in individual months and years.

Contra Costa Water District's Dr. Richard Denton proposed the G-model (Denton 1993) which would use 'G' flow as an indicator of the antecedent NDO flows. This 'G' flow is then used to calculate the salinity in the Delta at a location. However an NDO-only model cannot say anything about MEC as it is defined here, nor can it handle rim flow combinations and gate operation effects. Thus a model is needed that can handle multiple input variables and nonlinear relationships.

The California Department of Water Resources Delta Simulation Model (DWRDSM, California 1994) has been used to investigate MEC and related issues. The DWRDSM is an unsteady one-dimensional hydrodynamic and salt transport model. Like most numerical models, it is extremely slow for the needs of DWRSIM and therefore not a serious candidate for MDO routine

replacement. Even with a reduced model grid, DWRDSM run times would be far greater (on the order of thousands of times) than the current MDO routine.

Statistically based models of flow and salinity relationships have been tried and found lacking (Winkler 1985); classical time-series analysis (Shumway and Azari 1993) is often linear or requires transformation to a stationary time-series, which renders the resulting model unsuitable as an MDO routine replacement.

Recently, the California Department of Water Resources, Delta Modeling Section, has investigated a new mathematical technology called Artificial Neural Networks (ANNs) as an alternative to conventional techniques.

Why Use ANNs

Artificial Neural Networks (ANNs) are widely used, and for this particular application they can be thought of as a multiple non-linear regression technique. ANNs are universal approximators. That is, they are capable of modeling any function with a finite number of discontinuities to any desired degree of accuracy, given a sufficient number of hidden neurons. Thus, no prior assumptions, such as the determination of a transfer function, need to be made about the nature of the relationship between the input variables and output. Minimal preprocessing is required and different types of input variables can be used in the same network. Once calibrated, ANNs are fast and reasonably accurate and robust.

Neural Networks and Statistical Methods

Neural networks and statistical methods have been compared (Sarle 1994, Weigend and Gershenfeld 1992). One advantage that ANNs have over other curve-fitting methods such as polynomials or cubic splines is that the number of parameters does not increase exponentially with an increase in the number of inputs. For the polynomial case, the number of possible terms grows rapidly with the input dimension, making it sometimes impossible to use even all of the second-order terms. Thus, the necessary selection of terms to include implies a decision to permit only specific pair-wise or perhaps three-way interactions between components of the input vector. ANNs, rather than limiting the order of interactions, limit only the total number of interactions and learn to select an appropriate combination of input variables.

Drawbacks of ANN Technology

One of the significant disadvantages of ANNs is that they require more data to calibrate than conventional methods. In the case of the Delta, there is sufficient data (about 25 years of daily data) to calibrate and validate ANNs. Another drawback is that the only methods to optimize the weights are gradient-descent methods, which being iterative consume significant amounts of computing time. However, once trained, simulation only involves matrix multiplication and is quite fast. Finally, ANNs are black-box models and require extensive sensitivity analysis.

Introduction to ANNs

ANNs are composed of many simple elements called neurons connected through links (Masters 1993). A neuron with a single input and single output is shown in Figure 1-2. The input i is multiplied by a weight w . A bias term b can be added to the weighted input. The transfer function T takes this sum s and produces output or activation a . w and b are adjustable scalar parameters

of the neuron. The transfer function is defined by a function such as log-sigmoid as shown in Figure 1-6.

The inputs themselves may be referred to as input neurons and the outputs may be referred to as output neurons. All neurons other than inputs and outputs are referred to as hidden neurons.

An extension of the single input-single output neuron is the multiple input-single output neuron as shown in Figure 1-3. Two or more such neurons may be combined in parallel to form a layer of neurons as shown in Figure 1-4. Two or more such layers in series as shown in Figure 1-5 constitute an artificial neural network. Figure 1-5 shows a Feed-forward architecture for ANNs. If the outputs are fed back as inputs the ANNs are of a Recurrent type architecture.

DEVELOPMENT OF ANN MODEL

Software Used

SNNS v4.0 (Stuttgart Neural Network Simulator, version 4.0) was the package chosen in developing and training the ANNs. This package is public domain software which runs on X Windows on Unix systems. It has a wide variety of ANN architectures available and undergoes improvements every so often.

Architectures

Some of the types of ANN architectures tried were Feed-forward, Radial basis, Elman, Jordan, Cascade Correlation, Time Delay and fully Recurrent. The architectures with the best generalization characteristics (having minimum mean squared error [MSE] on calibration and also on validation sets) were Feed-forward, Time Delay and Recurrent; with Recurrent architecture doing a little better than Feed-forward architecture. At present, Feed-forward ANNs have been used due to their simpler architecture and faster training times. Also, until recently stand-alone code was available only for the Feed-forward ANNs.

Performance Indicators

The cost function used to train the ANNs was the sum-squared error. The mean sum-squared error (MSE) criteria was used in evaluating the fit in calibration and validation data sets. The mean square error is found by squaring the difference between the attained and target activations for each output neuron, and averaging across them all.

Training

Training is the name of the process of decreasing the MSE on the calibration set. The training process starts by initializing all weights to small non-zero values. The MSE is calculated, and the weights are updated in a such a way that the error is reduced. The MSE is calculated using the updated weights, and the process is repeated as needed. One such iteration is called a training cycle or epoch.

The process of propagating the error backward through adjusting the weights and biases is called backpropagation. This is the most common procedure used to train Feed-forward neural networks. "Standard Backpropagation" was found to be slow and more prone to getting stuck in

local minima, and therefore a more efficient "Scaled Conjugate Gradient" method was used in the training procedure.

Overfitting, Generalization, and the Importance of Validation

As neural networks are universal approximators, and can fit any function given a sufficient number of neurons, it is necessary to devise a principle of parsimony. This implies that if similar performance is given by two models, the model with the simpler structure (less number of weights) will be preferable to the more complex structure. In accordance with this principle, the network with the least number of hidden neurons which had smallest MSE on the validation set was used.

Neural networks are data-based models in that the weights and biases are calibrated from the data. Also it is theoretically possible to fit a particular data set very well yet lose the general characteristics. This is due to the fact that ANNs have a large number of weights and can start fitting the idiosyncrasies of the particular data set. This usually happens after the ANNs have fitted the simpler signal in the data set and then start fitting the more complex noise signal. The MSE of the calibration set decreases during training. However, the MSE of the validation set starts to increase. This phenomenon is called overtraining or overfitting.

Train
Validate

To avoid overtraining, the performance of the ANN on a validation set, which is not the same as the calibration set, is monitored. Training is stopped when the validation set MSE reaches a minimum. This technique gives a trained ANN which would follow the general trend in the data set and avoid fitting the noise. This technique has been used for all the ANNs mentioned in this report.

Data Description

Historical daily salinity data from 1981 to 1991, in the form of electrical conductivity or chloride concentration, was used from Pittsburg (PITTSBURGEC), Collinsville (COLLINSEC), Jersey Point (JPEC), Emmaton (EMMATONEC), Contra Costa Canal Pumping Plant #1 (CCCEC and CCCCL), and Clifton Court Forebay (CLFCTEC) to calibrate the ANNs. Another ten years (1971 through 1981) were used to validate the ANNs. Flow values were given in cubic feet per second (cfs), electrical conductivity values in micro mhos per centimeter (mmhos/cm), and chloride concentration in milligrams per liter (mg/l).

Net Delta Outflow (NDO) is composed of many component flows. The major ones are: Sacramento River flow (SAC), San Joaquin River flow (SJR), Eastside Stream flows (EAST), Central Valley Project pumping (CVP), State Water Project pumping (SWP), Channel Depletions (CD), and Yolo Bypass flow (YOLO). These component flows along with the Delta Cross-Channel Gate (DXC) position were initially given as multiple input variables to ANNs in a time lagged fashion. All flows were in units of cubic feet per second (cfs). The Delta Cross-Channel Gate closed position was indicated as 0.1 and open position as 1.1.

check
in
log
12

Another set of ANNs were trained on DWRDSM simulated salinity data using historical hydrologies. DWRDSM was run from years 1970-1990 using historical hydrologies. Salinity values were available at every fourth day. These values were linearly interpolated to create a set of daily salinity values. All salinity values from DWRDSM were in units of Total Dissolved Solids (TDS). These values were then used as target salinities to train a set of ANNs at channels 437 (Pittsburg), 049 (Jersey Point), 434 (Emmaton), 247 (Contra Costa Pumping Plant #1), and 083 (Clifton Court Forebay).

Preparation of input and some criteria used for ANN architecture selection

Any missing values in the data were filled with linearly interpolated data from the two nearest available data values. Inputs and outputs were scaled to the range [0.2,0.8], to ensure that the output would lie in the output region of the nonlinear log-sigmoid transfer function in the output layer. Also, doing so removes bias due to the magnitude of the input variables. Preprocessing of input variables was attempted by taking logarithms and inverses of input, which did not result in improved MSE in the validation set. Therefore, no logarithmic or inverse transformation of data was done.

Initially, a weekly time step was used in investigating the data. However, as the standards were written in terms of daily requirements, a daily time step was used for the purpose of this analysis. Monthly time steps were also investigated. However, it was found that a loss of information takes place in going to such a coarse time step.

Antecedent flows have always been found to be an important factor in the prediction of salinity in the Delta (Winkler 1985). Modeling of memory of input variables in the ANNs was done by including previous flows as inputs (Figure 1-7). Various memory lengths were experimented with to give the best generalization. The importance of memory can be seen by comparing Figure 1-11 with Figure 1-14.

All flow components were input in a time-lagged manner to represent information on the memory of the flows. For example, for the Sacramento River flow (SAC) input, the present and the previous 7 days' flow and previous to that 10 weeks' flow data were used as input variables to the ANNs. Figure 1-7 shows the structure of the inputs to the ANNs. The same input structure was used for all other inputs.

There are no good guidelines for selection of the number of hidden neurons or the number of hidden layers. Experimentation was done to determine a network with enough flexibility to do well on the calibration set and yet generalize well enough to perform well on the validation set. Two layers with four neurons in the first layer and two in the second layer were used for most locations (Figure 1-8).

SAC FLOW ESTIMATION METHODOLOGY

Goal of Modelling

The goal is to estimate SAC, given other flow conditions, such that a certain target salinity level is achieved. ANNs serve as a function relating the input flows to the target salinity at that location.

The hydrology was assumed to be in steady state over the next two months. That is, the flows are assumed to be constant over the next two months. In any particular month, the ANN model predicted the daily salinity for the next two months, given the flows. The cost function is defined as the difference between the ANN simulated salinity and the target salinity averaged over the present and next month.

The problem then became a root-finding problem with SAC as the variable to be solved for such that the cost function is zero with a certain tolerance level. A simple bisection search method was used to solve for SAC.

This SAC Flow Estimator is represented by a conceptual diagram as shown in Figure 1-9.

The reason for choosing such a cost function is that present conditions have very little effect on the present salinity in the Delta. The response of salinity to flow conditions is typically spread over a period of two to three months due to the memory of the system.

DISCUSSION OF RESULTS

The development of the ANN model was a process of trying out different ideas and looking at the results, then making changes in the model and going through the whole process again. Some of the main ideas tried are mentioned in the paragraphs below.

Memory

In initial model studies, a weekly time-step was assumed and two locations, COLLINSEC and CCCCL, were the focus of study (Figures 1-10 to 1-15). COLLINSEC is representative of the salinities at the boundary of the Delta with the San Francisco Bay. CCCCL is representative of the salinities in the interior Delta. CCCCL is influenced by both land salts (due to leaching of fields by farmers) and ocean salts, while COLLINSEC is affected mainly by ocean salt.

From experiments with these locations it was found that memory played an important role in the prediction of salinity, as can be seen by comparing Figure 1-11 with Figure 1-14. COLLINSEC is representative of the salinities at the boundary of the Delta with San Francisco Bay. This is the reason that the NDO-only as an indicator of salinity does fairly well versus multiple inputs at COLLINSEC. However, there is still some improvement from using multiple inputs even at this location, as seen by comparing Figure 1-10 with Figure 1-11. For CCCCL there is a marked improvement in going from using multiple inputs instead of NDO only (Figure 1-12 versus Figure 1-13). This is due to the complexity of land salts influencing interior Delta salinities. Also, due to the physical proximity of pumping stations to CCCCL, it is preferable to introduce component flows as input.

Multiple- vs. Single-Input ANN

The decision to use individual components of NDO instead of an NDO-only input led to improved prediction of salinity at all salinity locations and especially at the interior Delta locations. This would imply that the Delta is not a fully mixed estuary. Also, conceptually a multiple input model can simulate the effect of barriers and combinations of rim flows, which would not be possible if only a single lumped parameter were used in determining the salinity.

Sensitivity analysis was done using a simulator which was developed for this purpose. The simulator has sliders for each input flow and a toggle button for DXC. A time period of approximately 100 days of calculated salinity was plotted for any condition determined by the state of the sliders.

Using sensitivity analysis it was observed that SAC (Sacramento River flow) was the most important input. The exports (CVP and SWP) and DXC gate position were the next most influential inputs. CD influenced the interior stations more than it did for locations on the boundary of the Delta with the San Francisco Bay. EAST and YOLO have virtually no effect on salinity at any of the locations examined.

Pruned ANNs

Pruned ANNs are neural networks in which some of the connections between the neurons have been removed. The pruning algorithm looks for the connection that has the least impact on the value of the objective function (the SSE between the target and the output) and removes it from the ANN structure. This process is repeated until further pruning affects the SSE objective adversely, at which point the pruning procedure is stopped. Figures 1-10 and 1-15 show the difference between the two techniques. Because training time increases significantly to prune ANNs for a small improvement in error, it was decided not to prune ANNs.

DXC Gate Operation

Extensive testing of the ANNs using this simulator showed excessive reaction of PITTSBURGEC to change in DXC. It is speculated that this is because the DXC is highly correlated with SAC. That is, DXC is closed during high SAC flow and open during low SAC flows in the historic data used. This kind of bias in the data could explain how DXC could be responsible for lower PITTSBURGEC when closed and higher PITTSBURGEC when open.

It is proposed to train ANNs on DWRDSM where each individual flow input and gate position can be varied independently of each other. This may solve the above problem. However, no good method is known to solve the above problem for historical data. Therefore, in the current model DXC was dropped as an input. This limits the ANN model use to flow inputs with historical DXC operations only.

In attempting to solve for the above problem for historical data, it was proposed to use RIO and XGEO flows instead of SAC and DXC. However, a similar and somewhat stronger correlation exists between XGEO flows and salinities.

Choosing Flow Inputs

YOLO was dropped, as it had not much influence on salinity in the Delta, probably because it has flows during wet season when salinity is at its lowest. EAST was found to be correlated to SAC and SJR and was dropped as an input. Precipitation (PREC) was tried as an input but discarded due to its being relatively insensitive with respect to the output, as shown by the simulator experiments.

As a final cut, the following were used as inputs to the model: SAC, SJR, CD, CVP, and SWP. The results for historical-data-trained ANNs and DSM-output-trained ANNs are shown in Figures 1-16 to 1-25 and Figures 1-26 to 1-35, respectively.

Sensitivity Analysis

One of the problems with the sensitivity analysis is that it implies a steady-state problem. That is, given all other input variables to be constant, only one of them is varied to get a change in salinity. There is an implicit assumption of stretch invariance of the flow/salinity relationship in the Delta (Wan 1995). That is, if the flows were to vary much slower than they do in historical data, would salinity still follow the same trend as it does with a stretched time scale? The ANNs have never been trained on a truly steady-state Delta, as such a period has never existed. The above problems are not just limited to the ANNs but would be true of any statistical model or model whose parameters are based on historical data calibration. If the above problems and the limitations

thereof are understood, the ANNs can provide an indication to the actual sensitivity of the inputs to salinity.

WWW Simulator

For further sensitivity analysis a simulator was built to use historical flows as inputs. This simulator is written in java. Java is programming language which enables browsers to download programs and run them inside of a java compatible browser. Java enables the same byte-code to run on an operating system in which a Java Virtual Machine has been implemented. Currently that includes platforms such as Windows 95/NT, Solaris, and Macintosh operating systems. Support for other operating systems such as OS/2 is also being worked on.

This simulator uses historical hydrology as input for simulating salinities at various locations. The historical flows can then be modified by adding, subtracting, multiplying or dividing them by any value. The modified flows are then inputs to the ANN model, which gives the salinity values at various locations for these modified inputs. The simulator then plots the salinity due to the changed inputs, the simulated salinity for historical hydrology, and the historical salinity.

The java based simulator is currently available from the Delta Modeling Section's Home Page at:

<http://www.delmod.water.ca.gov/docs/neural/AnnMIapp.html>.

Seasonality

Seasonality is the change in response to the same input at different times. One example of this is the increase in salinity with increase in SAC as shown in Figure 1-36. Usually salinity in the Delta decreases as SAC increases. However, from the historical data there is an indication of the opposite being true at times. It is hypothesized that leaching of the fields by the farmers and runoff on previously dry land causes the introduction of salinity in the Delta.

To be able to model this phenomenon, various approaches were tried. Ocean salt and land salt were the two major sources of salinity in the Delta. From speculation about agricultural practices and data, it was assumed that rainfall would be an indicator of leaching of fields. One of the approaches entailed separating the data into summer and winter months. However this did not lead to an improvement in modeling the historical data. 'G' flow from G-model was used as a filter to identify periods of salt in the Delta. However, this too proved to be of little help.

From careful observation of the data, it was observed that there were periods when CCCEC would rise and fall and there would be no similar trend in PITTSBURGEC. As PITTSBURGEC is at the boundary of the Delta with the ocean, it could be safely concluded that the increase in salinity at CCCEC was not due to ocean salt intrusion. Data filtered to those periods, when CCCEC would rise and fall while PITTSBURGEC would not show a similar trend, always showed increase in salinity with increase in SAC flow.

After much experimentation, PREC and CD were shown to be indicators of salinity during these periods. However, as the aim was to use the ANN model in the planning stage, it was proposed to exclude this part of the model in estimating salinities. Also, due to the probabilistic and man-made nature of the phenomenon, the scatter in the estimates was much greater than that for ocean salt predictions.

Validation of SAC Flow Estimation Model

Historical hydrology from years 1970-1990 was used as input to the model. The target salinity was the historical measured salinity. SAC flow was the only flow assumed to be unknown. The SAC flow was solved for every month and stored in memory for use as antecedent conditions for future months. The results are shown in Figures 1-37 to 1-46.

The second set of ANNs which were trained on DSM-simulated salinity were also used in estimating SAC, given the DSM simulated salinity as the target salinity. The results are shown in Figures 1-47 to 1-56.

To estimate the error associated with the inverse process (computing SAC from salinity), ANN-simulated salinities were used as the target salinities. If the inverse estimator were perfect, the predicted SAC should be identical to the historical SAC. Any error in predictions can be attributed to the SAC flow estimation methodology. The effect of this error on predictions is shown in Figures 1-57, 1-58, 1-59, and 1-60.

This method has a component of error due to the assumption of future flows to predict future salinities. This assumption has to be made at least over the next two months. One approach could be to do an iteration over time by first estimating flows and then using the future flow estimates to come up with better present flow estimates. However, for now a statistical validation is relied upon to show that the average of salinity difference over two months works well.

Plotting of Results

For all stations a cutoff Pittsburg salinity was used for determining the months for plotting the SAC flow and SAC estimates. This cutoff salinity corresponds to a period when the relationship between salinity and flow is no longer clearly defined. For example, at SAC flow of greater than 25,000 cfs, the PITTSBURGEC stabilizes at around 2,000 to 3,000 EC, and changes in SAC flow have very little effect on salinity. Cutoffs for some interior stations were chosen to exclude periods in which ocean salt had little influence on salinity. Most of the cutoffs chosen are below required salinity standards. This makes the cutoff justified both for modeling and meeting the standards.

Salinity standards at various locations and the cutoff adopted for each are displayed in the table below. To ensure uniformity, all units were converted to EC (electrical conductivity in micro mhos/cm). As can be observed, the cutoffs are at a salinity level below that required for meeting the lowest salinity standards at any location.

These cutoffs are only used as a filter in the final stage of displaying relevant data and do not play any part in calculating the SAC flow required to meet the salinity standards.

Plots for SAC flow calculations using PITTSBURGEC, CCCEC, CLFCTEC, JPEC, and EMMATONEC are shown in Figures 1-37 to 1-46. The scatter for CCCEC and CLFCTEC is greater, and may be due to the influence of land salts (salts introduced into the channels due to leaching of fields by farmers).

Sacramento river flow (SAC) was solved for by using monthly DWRDSM-simulated salinity values (years 1970-1990) and using DWRDSM-output-trained ANNS along with other historical conditions (Figures 1-47 to 1-56).

Table 1-1: Table of salinity standards vs cutoff

LOCATION	Salinity Standards (EC mmhos/cm)	Equivalent Pittsburg Salinity (EC mmhos/cm)	Historical Data cutoff (EC mmhos/cm)	DWRDSM 20 year run cutoff (EC mmhos/cm)
Pittsburg	> 10,000	10,000	4,000	
Emmaton	630 - 2,780	6,000 - 12,000	4,000	4,000
Jersey Point	740 - 2,200	6,000 - 12,000	4,000	4,000
Contra Costa Pumping Plant #1	720 - 1,080	7,000 - 13,000	6,000	6,000
Clifton Court Forebay	1,130	12,000	6,000	6,000

MARGINAL EXPORT COST CALCULATIONS

To calculate the Marginal Export Cost (MEC), exports are perturbed by a certain amount and SAC flow is recalculated to keep the salinities at their previous levels at that location. These costs are expressed as a percentage of the marginal exports required. A 30 percent MEC would imply a Sacramento River inflow requirement of 1300 cfs for a 1000 cfs increase in exports to maintain the same salinity at the station in question.

Continuous Impulse MEC (CIMEC)

One way to perturb the exports is by changing the exports over an extended period of time and recalculating the SAC flow required for this period. The MEC calculated using this method is termed as Continuous Impulse MEC.

Let the exports over a certain period of time be represented by a time series $E_{ti}, E_{ti+1}, \dots, E_{tf}$ where ti is the initial period to the time series and tf is the final period of the time series. Let the calculated SAC for the same period be $S_{ti}, S_{ti+1}, \dots, S_{tf}$.

Let the exports be increased by IE for all periods of the time series giving a new time series of exports $E_{ti}+IE_{ti}, E_{ti+1}+IE_{ti+1}, E_{tf}+IE_{tf}$, where $IE = IE_{ti} = IE_{ti+1} = IE_{tf}$. If the SAC is recalculated to keep the salinity at their previous levels then we have a new time series of SAC as $S_{ti}+IS_{ti}, S_{ti+1}+IS_{ti+1}, \dots, S_{tf}+IS_{tf}$. Then a time series of CIMEC can be calculated as $IS_{ti}-IE_{ti}, IS_{ti+1}-IE_{ti+1}, \dots, IS_{tf}-IE_{tf}$.

CIMEC has been calculated using historical salinity to be the target for SAC calculations. The results are shown in Figures 1-61 to 1-80 and Figures 1-101 to 1-110. The plot of CIMEC versus salinity at that location is done to see if any relationship exists between salinity and positive CIMEC. The general distribution of CIMEC is shown by the relative frequency plots. All calculations for CIMEC are shown for the appropriate cutoff periods as discussed above.

Transient Impulse MEC (TIMEC)

The perturbation can be done by changing the exports for the month in question and then recalculating the SAC flow required to keep the salinities at their previous levels. After this calculation, the exports and SAC flow are reset to the historical values as the calculation proceeds to the following month. The MEC calculated using this method is termed as Transient Impulse MEC.

Let exports for the present month be E_t and the SAC flow be S_t . Let the exports be increased to $E_t + IE_t$ where IE_t is the increase in exports. SAC flow is recalculated to keep the salinity at the particular location at its previous levels. Let this recalculated SAC be $S_t + IS_t$ where IS_t is the increase in SAC. Then $TIMEC = IS_t - IE_t$.

TIMEC has been calculated using historical salinity to be the target for SAC calculations. The results are shown in Figures 1-81 to 1-100 and Figures 1-111 to 1-120. The plot of TIMEC versus salinity at that location is done to see if any relationship exists between salinity and positive TIMEC. The general distribution of TIMEC is shown by the relative frequency plots. All calculations for TIMEC are shown for the appropriate cutoff periods as discussed above.

General Comments

The plots for TIMEC and CIMEC show that in general TIMEC is higher than CIMEC for most locations. This is due to the fact that the calculation of TIMEC involves a sudden perturbation and the system has only a couple of months to bring the salinity to previous levels by changing SAC flow. The changed SAC flow cannot immediately affect salinity, and thus SAC must be higher in value to compensate for the shorter time period it has to act.

DWRDSM MEC in general is higher than historical trained MEC.

The plots clearly show MEC to be positive in many months. The trend in MEC is an increasingly positive trend as one goes from the western Delta towards the pumps in the southern Delta. This trend is reflected both in the historical data trained ANNs and the DWRDSM output trained ANNs.

FUTURE DIRECTIONS

The relationship of TIMEC or CIMEC with salinity conditions is not well understood at present. Further investigations are needed to have better understanding of MEC and its relationship to conditions in the Delta.

One of the important issues in modeling is the confidence in the output of the model. To get an estimate of the errors involved with the ANNs and an indication of the confidence interval, bootstrapping or some similar technique would be used.

REFERENCES

- Barnes, G. W., and F. I. Chung. (1986). "Operational Planning for California Water System." *Journal of Water Resources Planning and Management*, ASCE, 112(1): 71-86.
- Denton, R. A. (1993). "Accounting for Antecedent Conditions in Seawater Intrusion Modeling: Applications for the San Francisco Bay Delta." Proceedings, 1993 ASCE Hydraulic Engineering Conference, San Francisco, CA, 448-453.
- Masters, Timothy. (1993). *Practical Neural Network Recipes in C++*, Academic Press, Inc.
- Rayej, Mohammad and Francis Chung. (1993). "Mathematical Modeling of the Sacramento-San Joaquin Delta." Proceedings of the 1993 National Conference on Hydraulic Engineering, San Francisco, Vol. 1, 436-441.
- Sarle, Warren. (1994). "Neural Networks and Statistical Models." Proceedings of the Nineteenth Annual SAS Users Group International Conference, Cary, North Carolina. pp. 1538-1550.
- Shumway, Robert H. and Rahman S. Azari. (1993). "Statistical Analysis of Historical Delta Water Quality Data." Report prepared for Delta Modeling Section, Division of Planning, California Department of Water Resources under Contract No. B-59259.
- Wan, Eric. (1995). Personal Communication, Assistant Professor, Oregon Graduate Institute.
- Weigend, Andreas S. and Neil A. Gershenfeld. (1992). "Time Series Prediction: Forecasting the Future and Understanding the Past." Proceedings of the NATO Advanced Research Workshop on Comparative Time Series Analysis, Santa Fe, New Mexico, May 14-17, 1992. pp. 25-29.
- Winkler, Edward D. (1985). "Preliminary Development of a Statistical Approach to Salinity Modeling in the Western Sacramento-San Joaquin Delta and Suisun Bay." California Department of Water Resources, Technical Information Record, Study Code No. 1463-CD-04, April 1985.

2 Historic Correlations and ANN Development

Earlier sections of this report described how early ANNs trained only on historic data could not correctly model the effects of DXC operation. A Pittsburg ANN trained only with historic flow data was used to show how the historic correlation between DXC operation and salinity could inhibit ANN model development. It was suggested that training ANNs using DWRDSM simulated salinity could reduce the errors caused by historic correlation.

This section revisits the historic correlation problem and its effect on ANNs at Pittsburg and Contra Costa Canal (CCC), which were trained using historic rimflows and DXC gate position data, along with DWRDSM generated salinities. A methodology for "decorrelating" the training inputs is proposed, and this method is applied to ANN development at Pittsburg and CCC. The results of this experiment are then shown.

Historic data and DSM2 generated salinity were used to train an ANN to predict EC at Pittsburg. This ANN was then used to predict daily salinities for the period October 1976 to September 1981. Two cases of DXC operation were simulated. The first case simulated EC using historic flows where the DXC gate was kept closed for the entire simulation period. The second case again used historic flows, but the DXC gate was kept open for the simulation period. Figure 2-1 shows the simulated EC values.

Historically, during periods of high salinity the DXC gate has been opened, and during periods of low salinity the DXC gate has been closed. An operational decision has been made to operate the DXC in this manner to control salinity in the interior Delta, and there is no actual cause/effect relationship between DXC gate operation and EC at Pittsburg. However, this apparent relationship is reflected in the training data and this can adversely affect an ANN's ability to accurately learn how flows affect salinity at Pittsburg. ANNs cannot differentiate between relationships caused by operational decisions and relationships dictated by hydrodynamics and salinity transport laws. The relative positions of the DXC gate and Pittsburg indicate that EC at Pittsburg should be relatively insensitive to DXC operation. Since Pittsburg EC should be insensitive to DXC operation, any errors induced by historic correlation should be readily apparent.

The effects of the correlation of DXC operation and historic salinity can be seen in Figure 2-1. Closing the gate often seems to cause lower EC values, and opening the gate seems to result in increased EC values for the simulated period.

Similarly, another EC ANN was prepared for the Contra Costa Canal location using historic flows and DSM2 generated EC data for training. Figure 2-2 shows how EC values vary for two simulated cases. The first case simulates EC using historic rimflows while the DXC was kept closed, whereas the second case simulates EC for the same historic conditions but the DXC gate kept open for the entire period. Daily values were calculated for the period starting October 1976 and ending September 1981.

Since CCC EC is actually affected by DXC gate position, the problem caused by historical correlation is not as readily apparent, but the plot does seem to show that this ANN has not correctly captured the relationship between DXC gate operation and CCC EC. If the rimflows remain constant for both runs, we expect the DXC open run to return the lowest EC estimates and

the DXC closed run to consistently return the highest EC estimates. Figure 2-2 shows that there are several points on the plot where the DXC closed line falls below the DXC open line.

In order to reduce the effects of historic correlation, the historic training set was augmented. The original training set was composed of 16 years of historic flows and gate position data. A second 16 years of data was simulated by using the same historical flows along with inverted DXC gate data. When the gate was opened during the initial 16-year period, the gate was kept closed in the second training period. Whenever the gate was closed during the initial 16-year period, the gate was opened during the second 16-year training period. The historic flows along with the inverted gate position data were fed into DSM2 as inputs and simulated salinities for the second 16-year period were obtained. It was hoped that this second training set could reduce the error caused by historic correlation seen at Pittsburg and CCC. These two training sets were merged into a 32-year training set consisting of rimflows, DXC position data, and simulated EC values. This augmented training set was used to train new ANNs to predict EC at Pittsburg and Contra Costa Canal.

Figure 2-3 shows how an ANN trained on Pittsburg EC using the augmented training set responds to varying DXC operation. This plot compares ANN-estimated EC for the DXC open and the DXC closed cases for the period from October 1976 to September 1981. The Pittsburg ANN trained on the augmented training set now correctly indicates that EC at Pittsburg is relatively insensitive to DXC operation. Both runs give EC values that are almost identical.

Figure 2-4 shows how the ANN trained on CCC EC data using the augmented training set performed for varying DXC operation. Again it is shown that augmenting the training set with the DXC inverted data improves ANN performance. The EC estimate for the DXC closed case is consistently greater than the estimate for the DXC open simulation. Figures 2-3 and 2-4 seem to indicate that augmenting the data set with the inverted DXC data allows us to develop ANNs which are capable of modeling the effects of DXC operation at westward Delta locations like Pittsburg and also at an interior Delta location such as Contra Costa Canal.

As a final check, our new ANNs trained on the augmented training sets were used to predict EC for the time period from October 1976 to September 1986. The DXC gate was allowed to operate normally and was allowed to open and close during the simulation period. The same DXC operation and rimflows were used in the original DSM2 run. The DSM2 simulated EC was compared to the ANN simulated EC for Pittsburg and Contra Costa Canal. The results of these comparisons can be seen in Figure 2-5 and Figure 2-6. These two plots show that in both cases our ANN networks seem to capture the functionality of DSM2 and the effects of DXC operation.

These results show how we can remove the error associated with historic correlation between ANN inputs and salinity by working to make our training sets as unbiased as possible. Typically, ANN development is restricted by the availability of adequate training data. Therefore, our data sets must be of both sufficient size and quality so that the ANN can learn the required flow salinity relationships within a reasonable number of training cycles.

Synthetic training sets using DSM derived salinity can provide us with an almost unlimited source of training data. The difficult part is creating manageable training sets which sufficiently exercise our model without unintentionally biasing our data.

3 Marginal Export Cost (MEC) Estimates Using ANNs

Marginal Export Cost (MEC) has been defined as the extra water needed to carry a unit of water across the Delta to the pumping plants for export while maintaining a constant salinity at a given location. MEC varies widely and is highly dependent on location and antecedent conditions. Incremental export increases may increase salinity in some areas while decreasing salinity in others. Modeling studies using DSM2 and ANNs can be used to study the complex interrelationship of flows and salinity in the Delta.

The Continuous Impulse Marginal Export Cost (CIMEC) method was used to study carriage water under historic conditions. Two separate investigations were performed. The first investigation looked at the effects of decreasing exports by 500 cfs and then recalculating the SAC flow needed to maintain salinity at a constant level. The second experiment attempted to quantify the MEC associated with the pumping required by the 1991 Drought Water Bank.

Both attempts used ANNs which used CVP, DXC position, SAC, SJR, and SWP as inputs and trained with DSM2 salinity output. The time period studied for the first investigation used historic data for the 5-year time span starting January 1989 to November 1994. The second study used 1991 historic data.

Jersey Pt. and Contra Costa Canal were chosen as the two study locations because they represent two interior Delta locations which have salinity standards which often control Delta operations and where the salinity/outflow relationship is relatively complex.

Effects of a 500 cfs reduction in SWP pumping

Jersey Pt. salinity, historic flows, and DXC gate position were used to obtain a baseline case by using the CIMEC SAC flow estimation methodology to calculate SAC flow for January 1989 through December 1994.

The historic SWP pumping data was then modified by reducing the SWP exports by 500 cfs. SAC flow was then recalculated so that salinity at Jersey Pt. remained at historic levels. Figure 3-1 shows how the 500 cfs reduction affected the calculated SAC flow values. Monthly carriage water was calculated using the following equation:

$$\begin{aligned} \text{C.W.} &= (\Delta\text{Exports} - \Delta\text{Calculated SAC flow}) \text{ or} \\ \text{C.W.} &= ((\text{Hist. SWP pumping} - 500\text{cfs}) - (\text{Hist. SWP pumping})) - \\ & \quad ((\text{Calc SAC with exports reduced by 500cfs}) - (\text{Calc SAC for historic conditions})) \end{aligned}$$

Figure 3-2 shows monthly calculated carriage water at Jersey Pt. expressed in cfs and also as a percentage of export reduction. Carriage water percentage can either be zero, negative, or positive. A zero value implies that there is a one to one correspondence between incremental increases in pumping and the incremental increase in SAC flow needed to maintain salinity levels at a given station. A negative percentage implies that $\Delta\text{SAC flow}$ is less than $\Delta\text{Exports}$, while a positive

carriage water percentage implies that Δ SAC flow is greater than Δ Exports when SAC flow is adjusted to keep salinity constant.

The monthly percent carriage water at Jersey Pt. is generally positive but showed some variation which may be attributed to the varying flows and DXC position.

The total average carriage water value for the entire period was defined as $\text{Avg C.W.} = \Sigma (\text{monthly calculated C.W.}) / \Sigma (\Delta\text{exports})$ and was found to be about 9 percent.

This experiment was repeated for the same time period using salinity at Contra Costa Canal (CCC). Figure 3-3 shows how the 500 cfs reduction affects the estimated SAC flow values when SAC flow is calculated using historic salinity at CCC. Monthly carriage water values also were calculated and are shown in Figure 3-4.

When CCC salinity is assumed to be controlling, the monthly carriage water ratio varies from -90 percent to 60 percent. The monthly percent carriage water with CCC controlling is much more volatile than the carriage water value observed when Jersey Pt. salinity is used. The overall average carriage water for the entire period with CCC controlling was 15 percent.

Estimate of carriage water for 1991 Drought Water Bank (DWB) Pumping

The second part of this experiment was to estimate the MEC associated with the 1991 Drought Water Bank (DWB) pumping. MEC was estimated once for Jersey Pt. EC controlling and also for CCC EC controlling.

Jersey Pt. historical salinity, historic rim inflows and exports, and DXC position were used to calculate SAC flow using the CIMEC method described earlier in this report. This calculated SAC flow was used as the baseline case.

The 1991 historic exports for SWP were then modified by subtracting the SWP exports attributed to the 1991 Drought water Bank from the historic SWP export data and SAC flow was recalculated. Monthly carriage water values were calculated and the results are shown in figure 3-5. The plot shows the monthly pumping made for the 1991 Drought Water Bank (DWB), the carriage water attributable to the 1991 DWB pumping, and the ratio of (C.W. for DWB pumping)/(avg DWB pumping).

The overall average carriage water for the 1991 Drought Water Bank Pumping period with Jersey Pt. controlling is estimated to be 8.9 percent.

The above process was repeated using Contra Costa Canal historic salinity. Contra Costa Canal historic salinity, historic rimflows and pumping, and DXC position were used to calculate SAC flow using the CIMEC method. Then as before, the 1991 DWB exports were subtracted from SWP pumping and the new reduced SWP values were used to recalculate SAC flow. Carriage water was calculated on a monthly basis and the results are shown in Figure 3-6. Figure 3-5 and Figure 3-6 show how calculated carriage water estimates can vary depending on controlling location and changing monthly conditions.

The average carriage water for 1991 DWB pumping with CCC controlling was calculated to be 14 percent.

These studies show how existing models can be used to further examine the relationships between salinity at a given location, rimflows, and gate operations. These preliminary results lead us to believe that as we continue to gain an understanding of these complex flow/salinity/gate operation relationships, opportunities to further optimize Delta operations will present themselves.

FIGURES

Figure 1-1. Sacramento-San Joaquin Delta

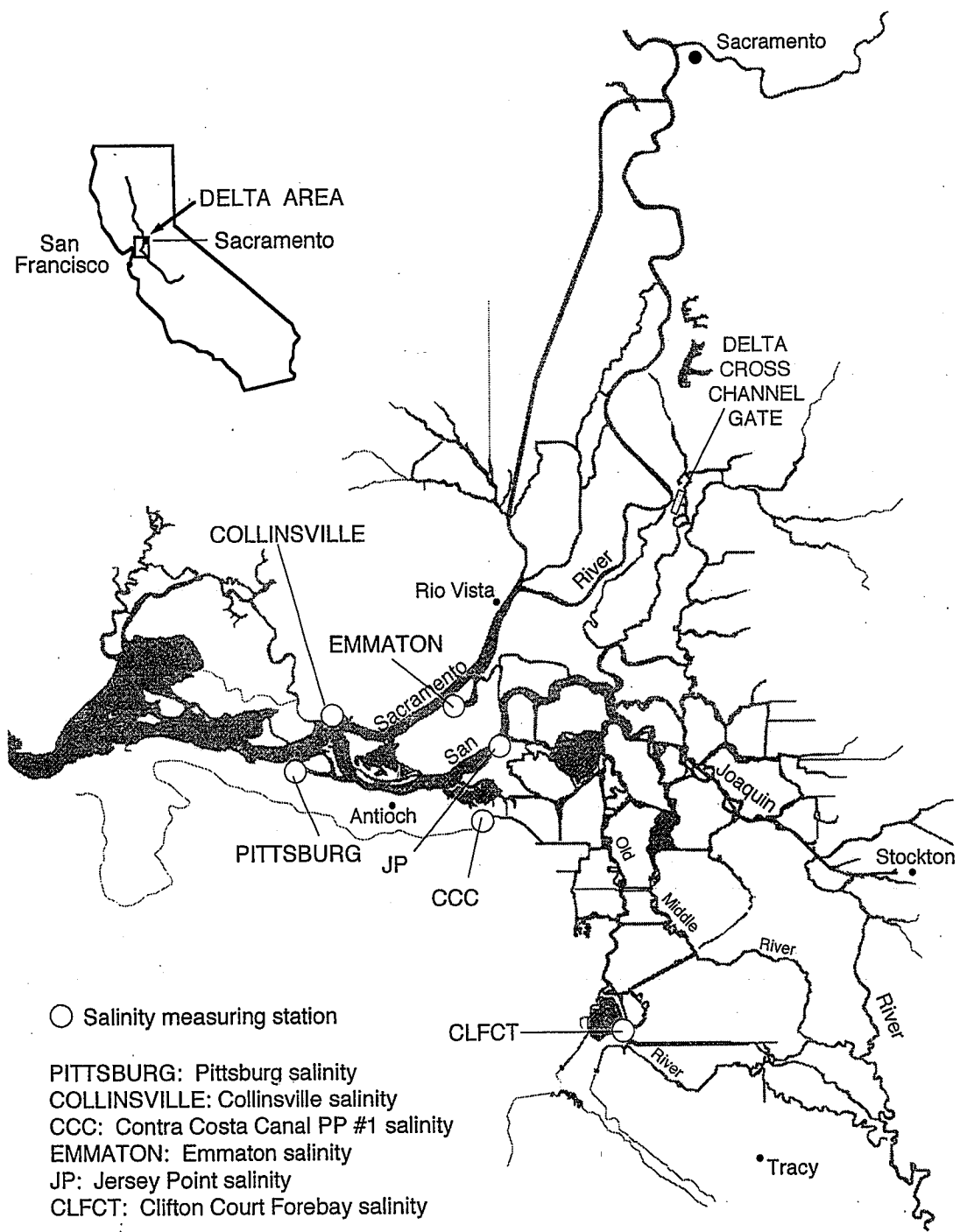

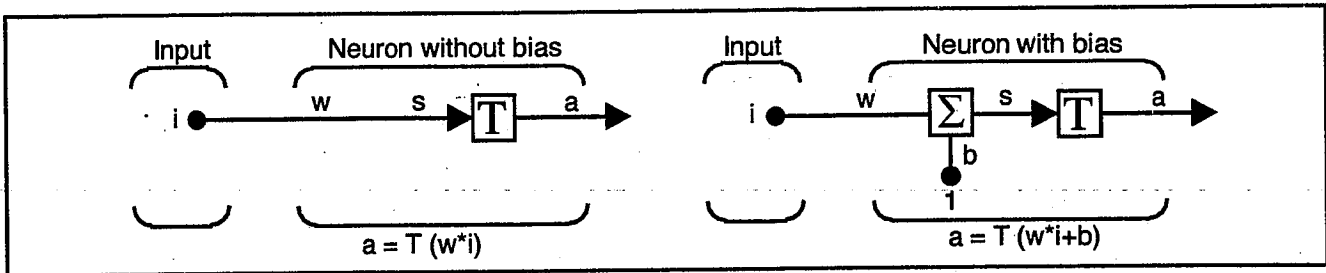

Figure 1-2. Single Input Neuron

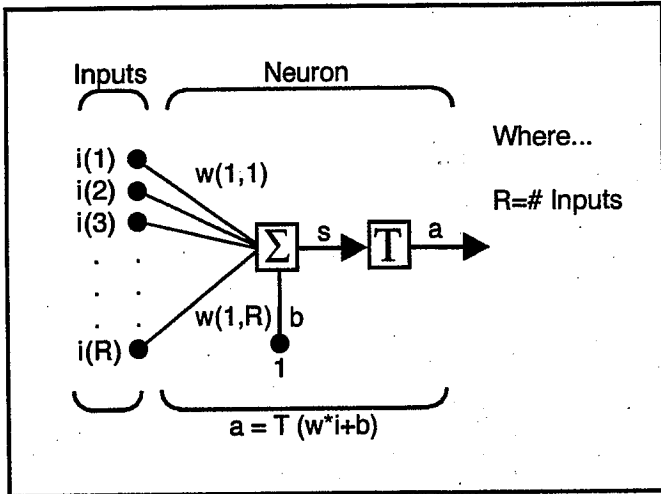

Figure 1-3. Multiple Input Neuron

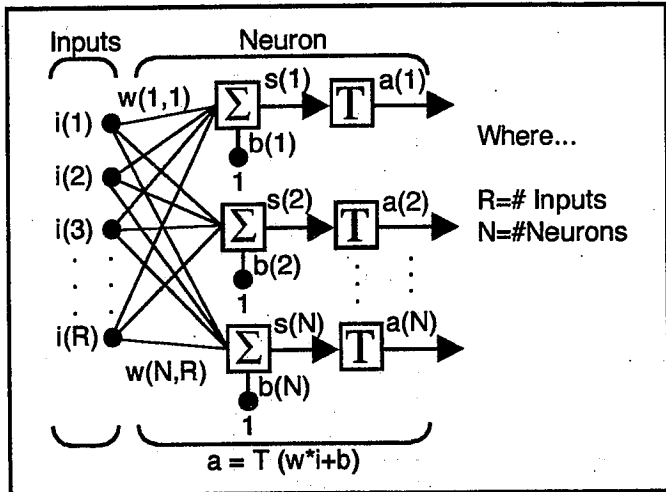

Figure 1-4. Single Layer of Neurons

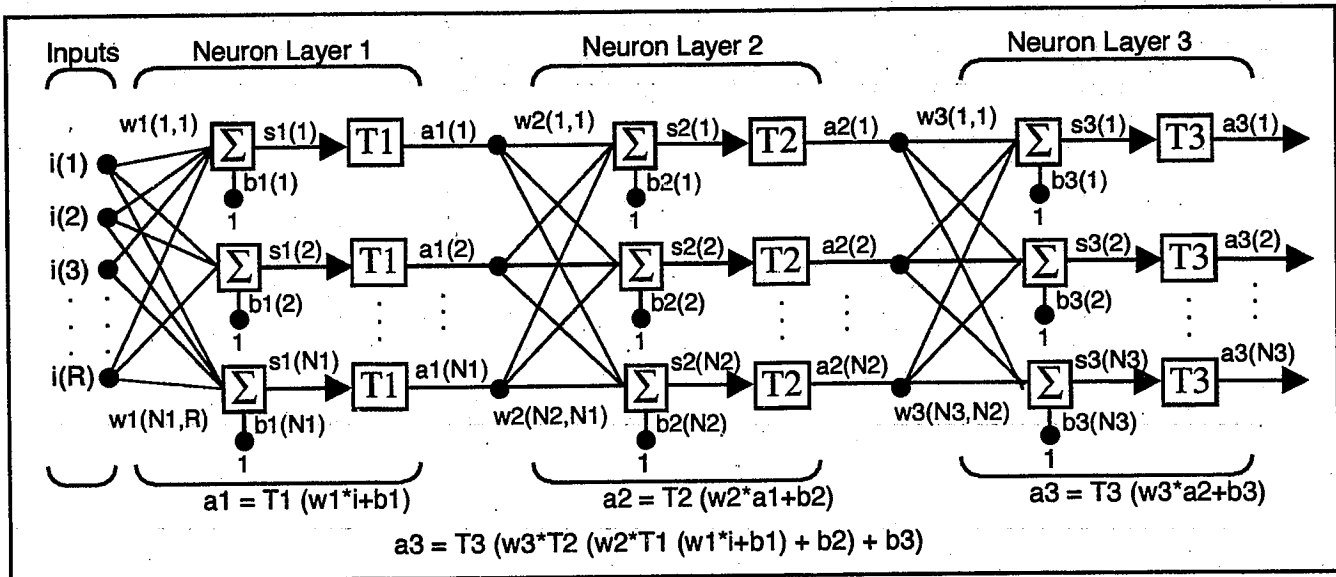

Figure 1-5. Neural Network

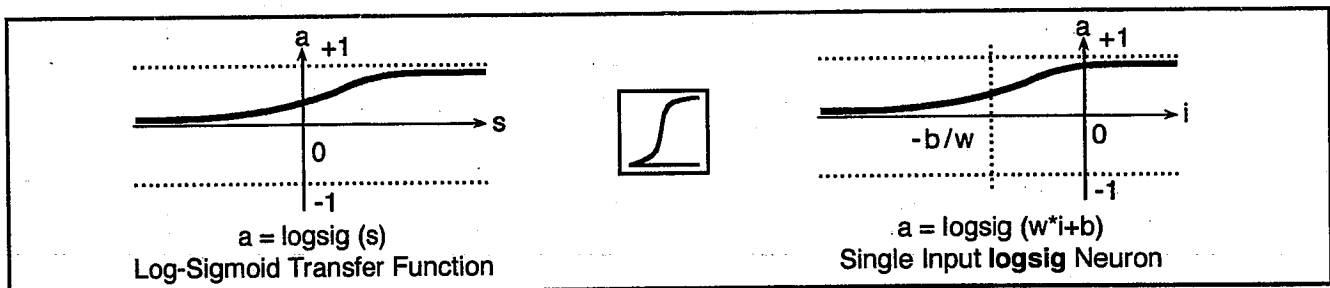
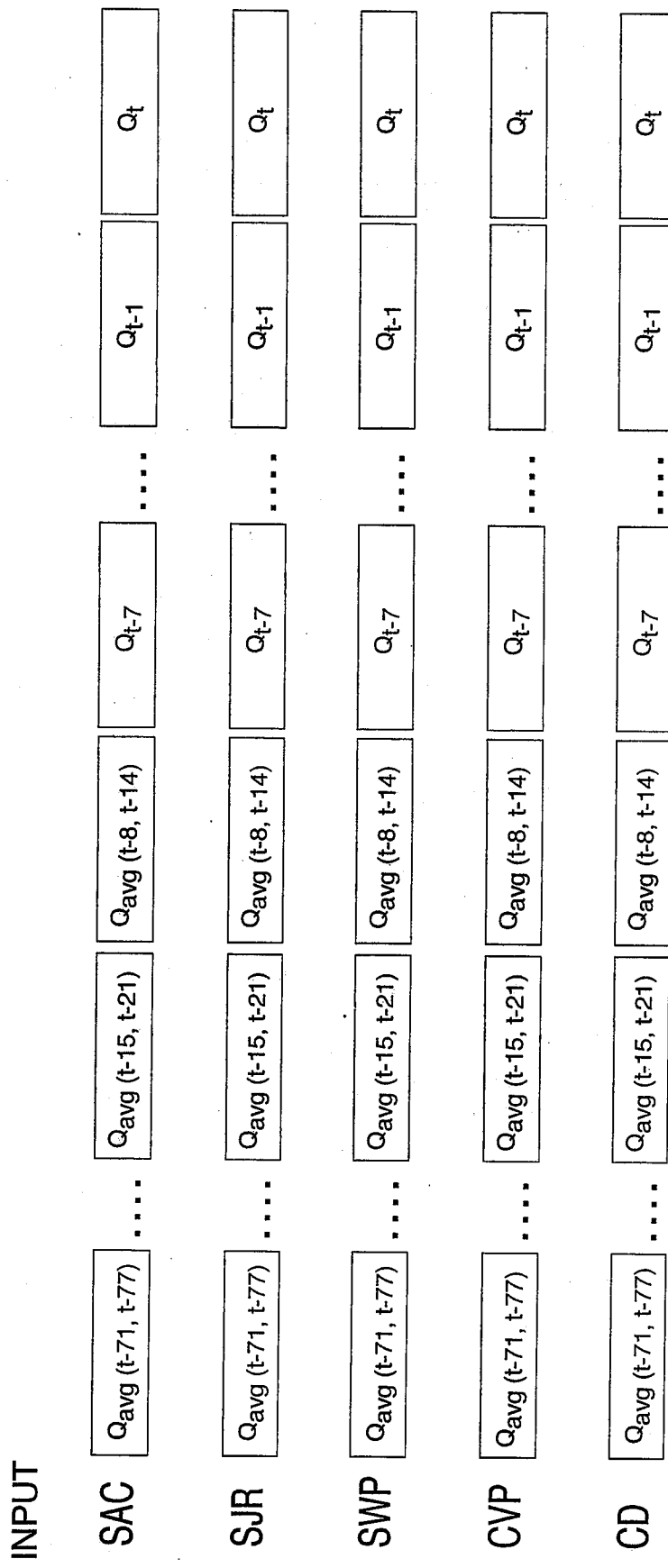

Figure 1-6. Transfer Functions

Figure 1-7. ANN Input Layer



Q_t = Averaged day flow @ time t in days (present time)

Q_{t-j} = Averaged day flow @ time t-j, where j is number of days

$$Q_{avg}(t-j, t-j) = \frac{\sum_{k=i}^j Q_{t-k}}{(j-i+1)}$$

Figure 1-8. Artificial Neural Network

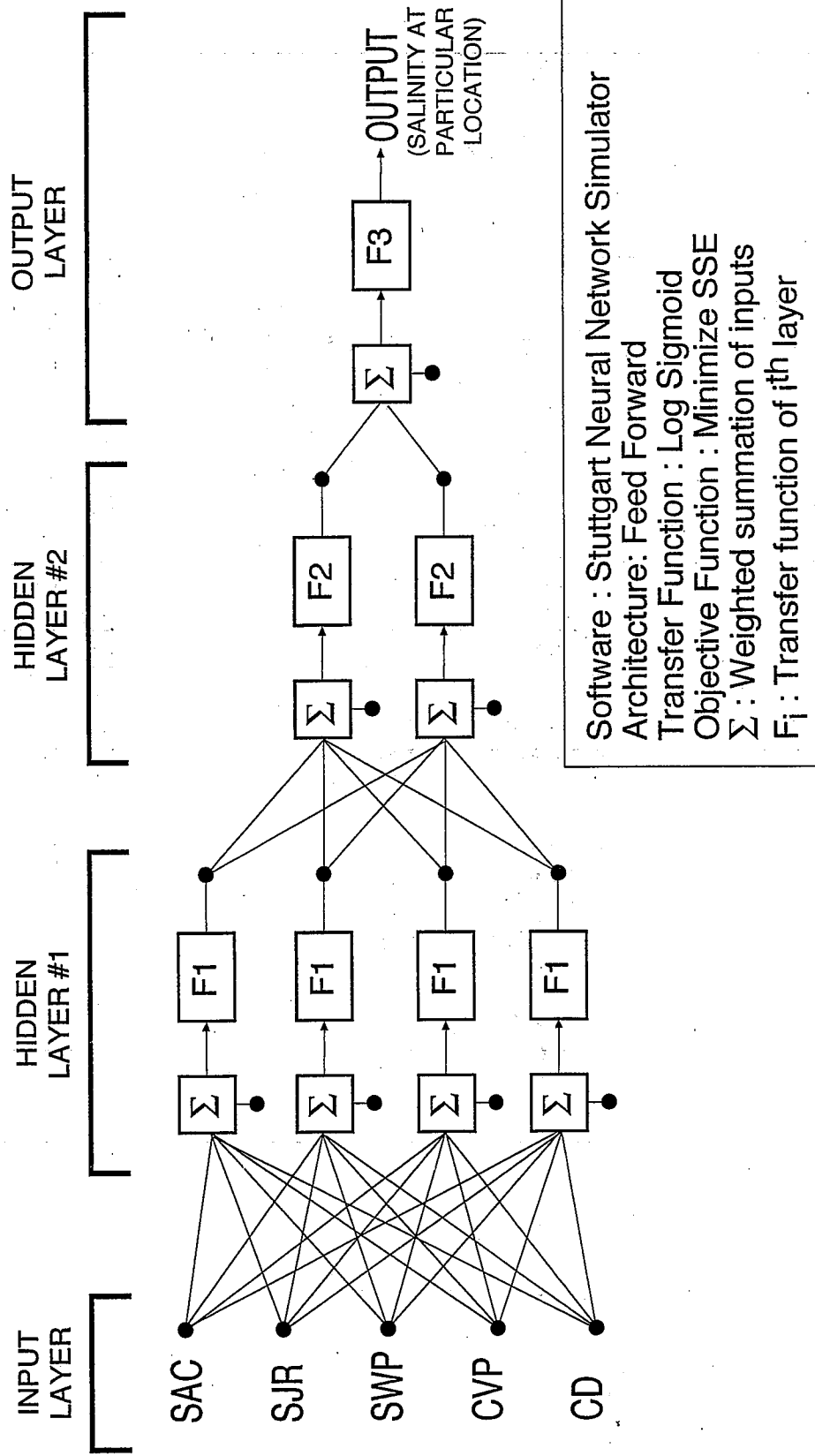
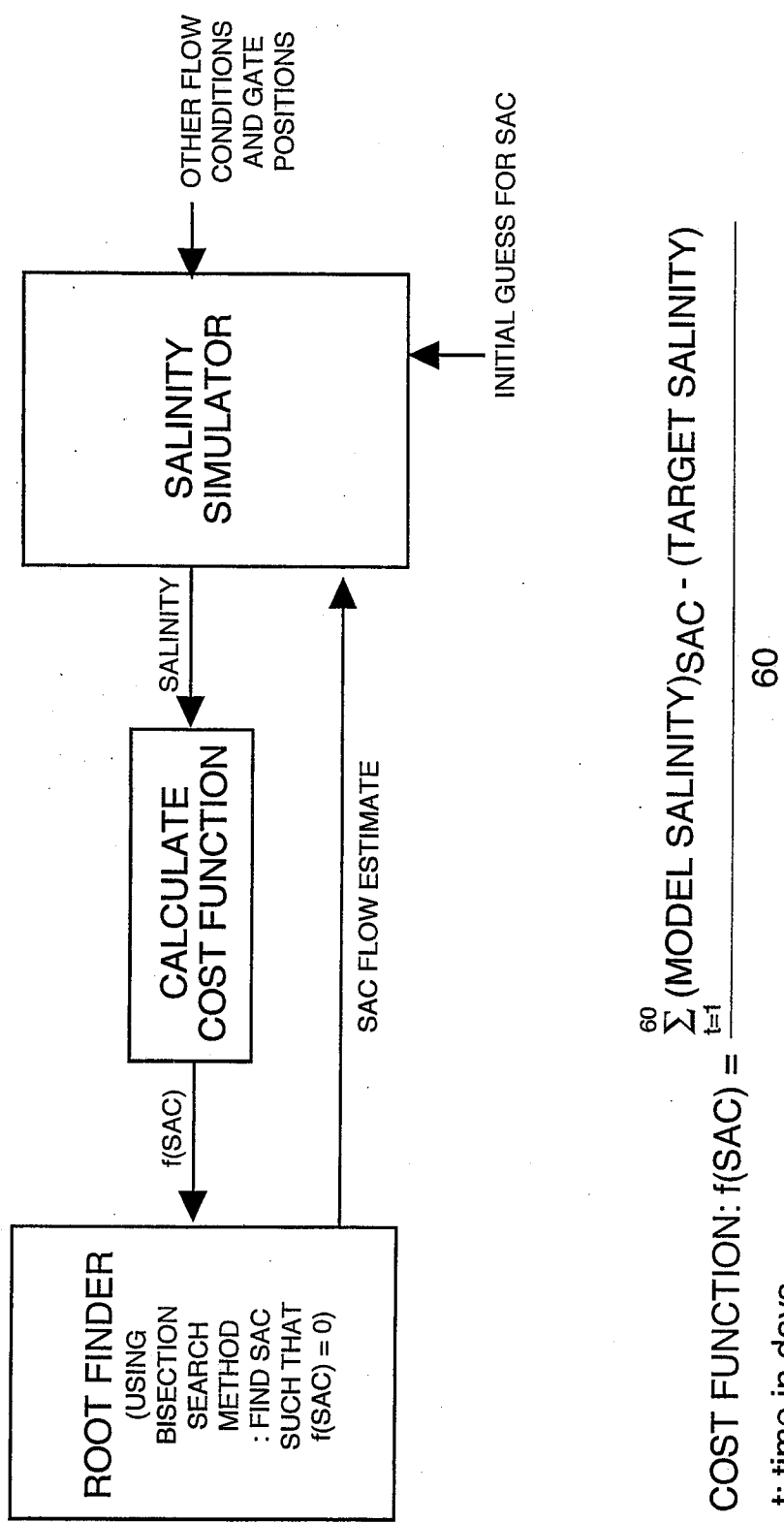

Figure 1-9. Sacramento River Flow Estimator



$$\text{COST FUNCTION: } f(\text{SAC}) = \sum_{t=1}^{60} (\text{MODEL SALINITY})_{\text{SAC}} - (\text{TARGET SALINITY})$$

t: time in days

SAC: Sacramento River Flow

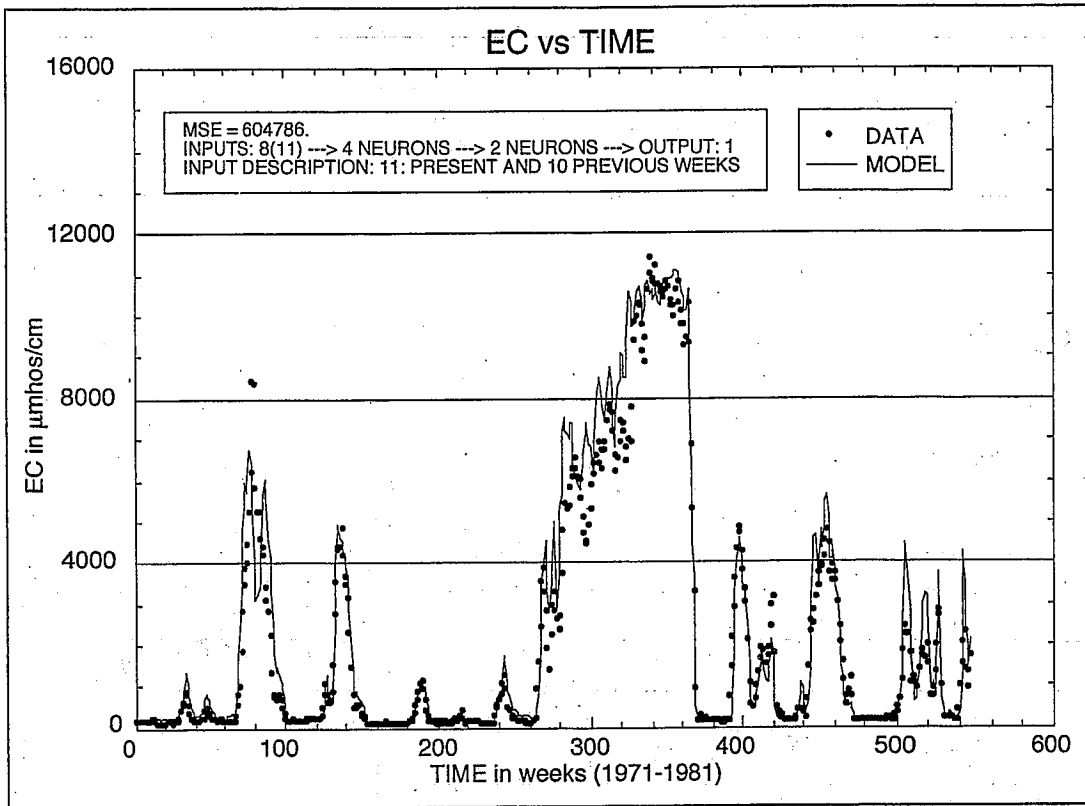

Figure 1-10. Collinsville EC Validation, Multiple Inputs, ANN Pruned

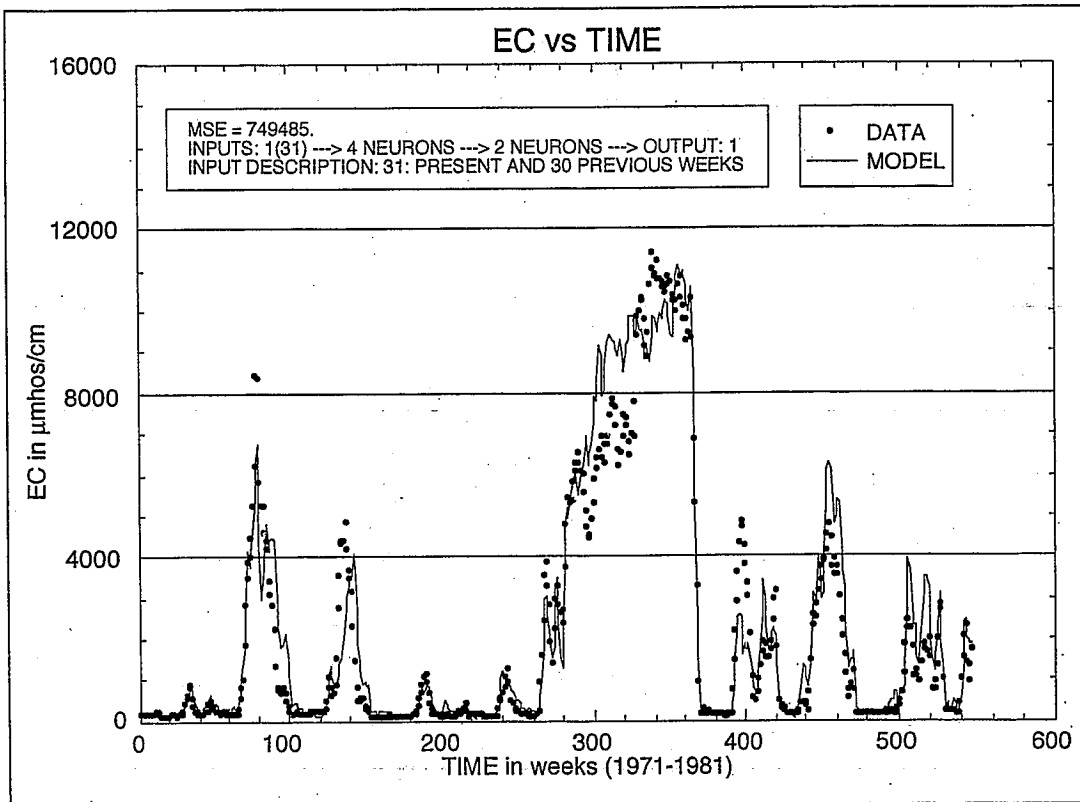

Figure 1-11. Collinsville EC Validation, NDO Only, with Memory, ANN Pruned

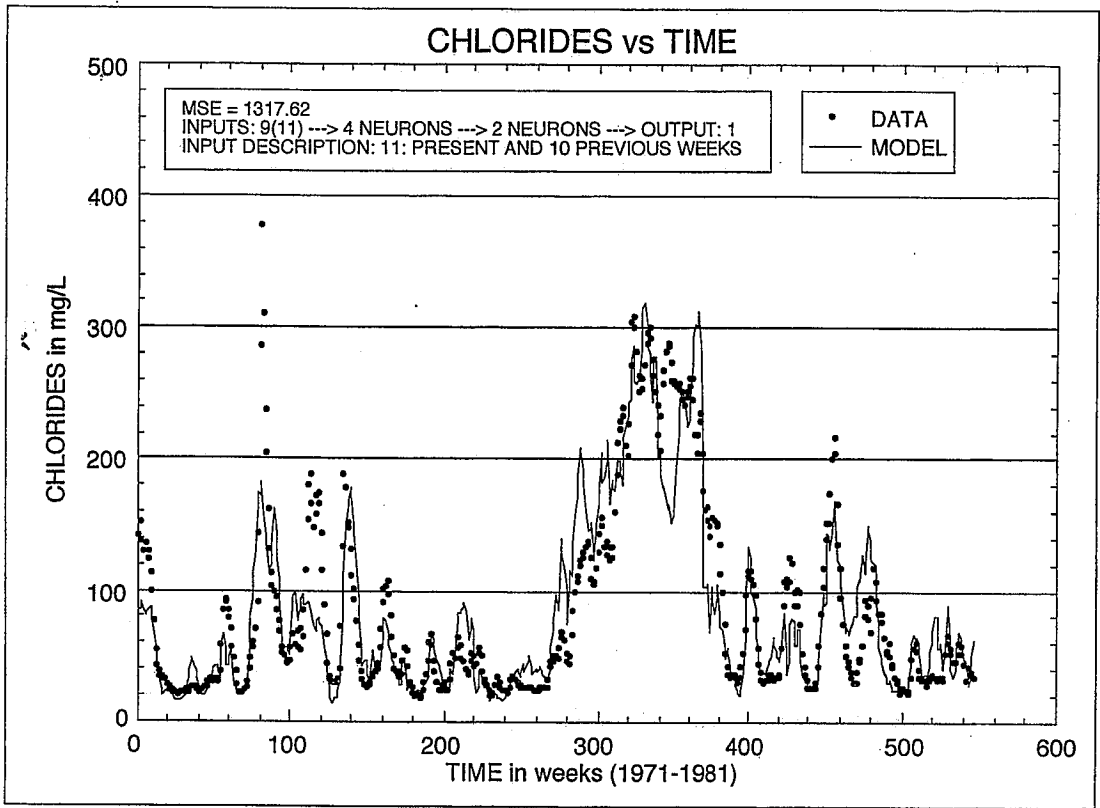

Figure 1-12. Contra Costa Chlorides Validation, Multiple Inputs, ANN Pruned

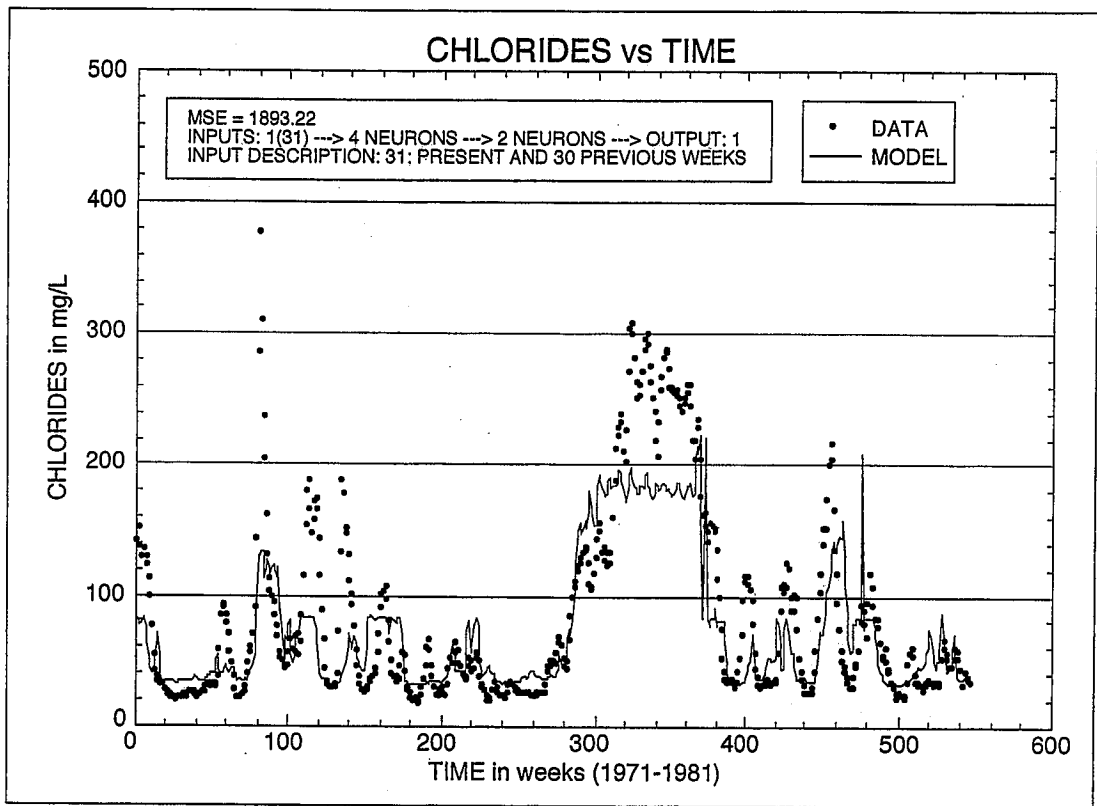

Figure 1-13. Contra Costa Chlorides Validation, NDO Only, with Memory, ANN Pruned

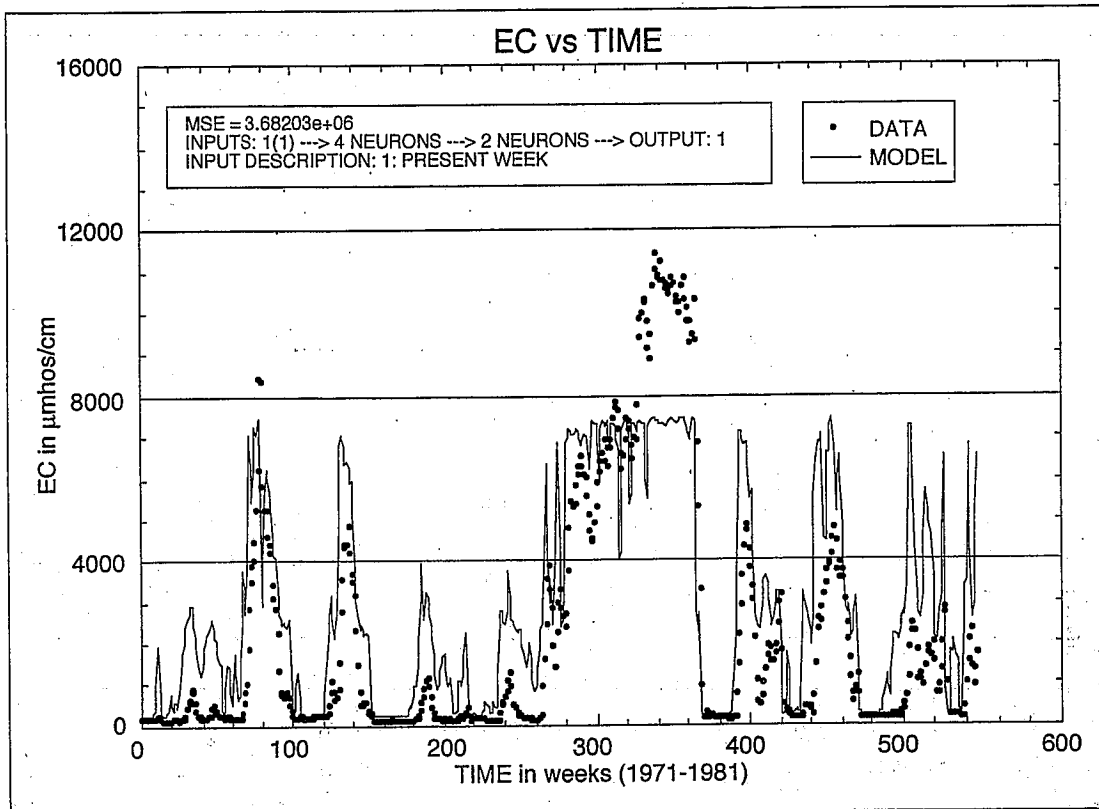

Figure 1-14. Collinsville EC Validation, NDO Only, No Memory, ANN Not Pruned

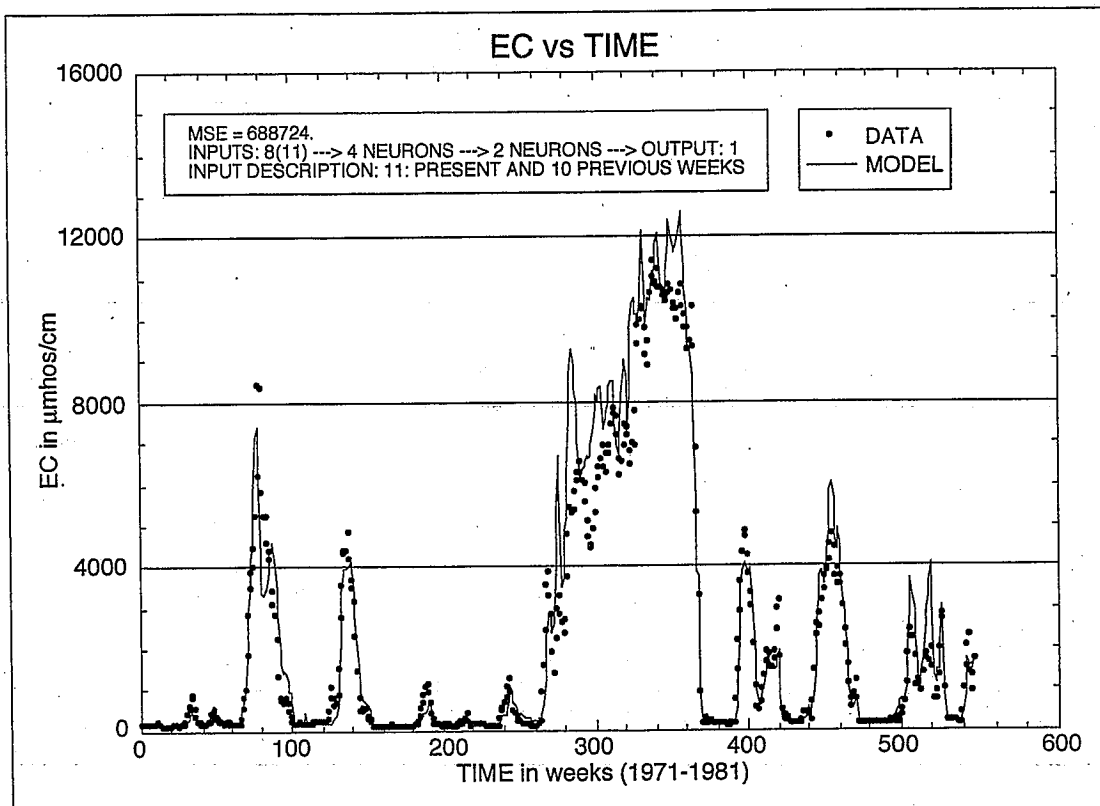

Figure 1-15. Collinsville EC Validation, Multiple Inputs, ANN Not Pruned

PITTSBURG TIME SERIES PLOT HISTORICAL DATA

FIGURE 1-16. ANN MULTIPLE INPUT MODEL

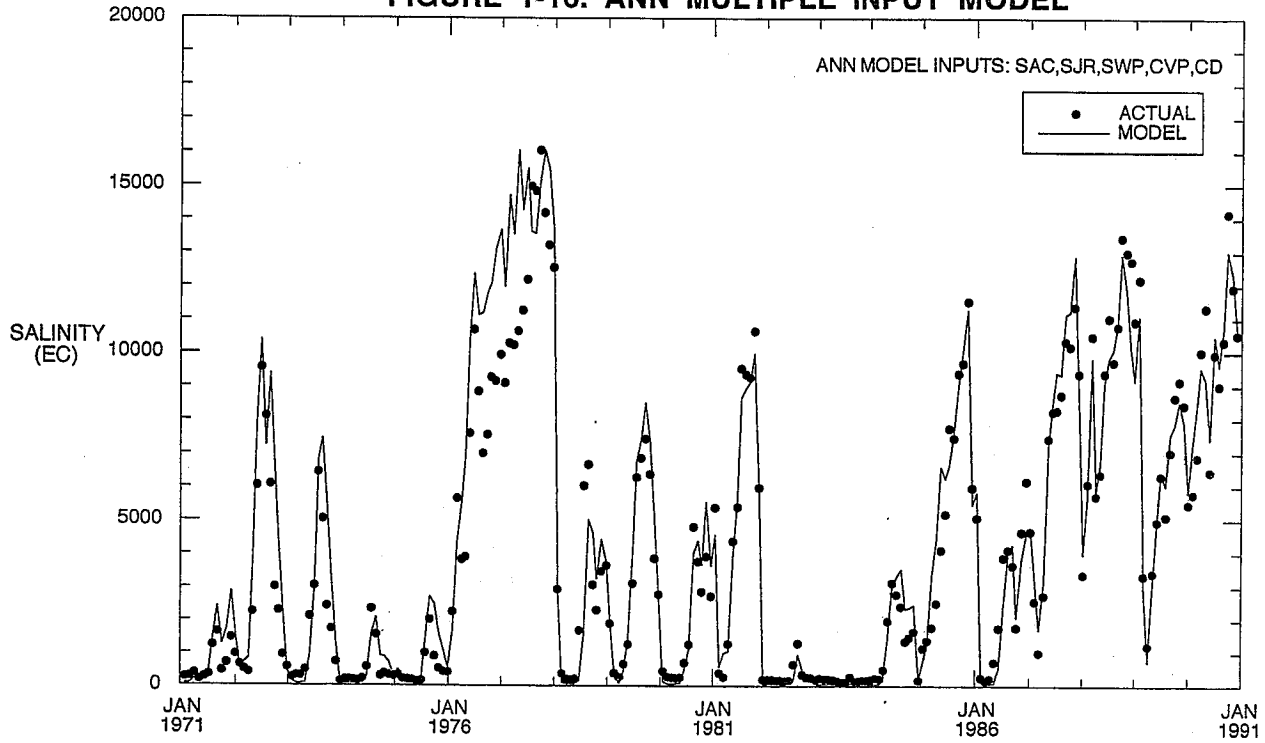
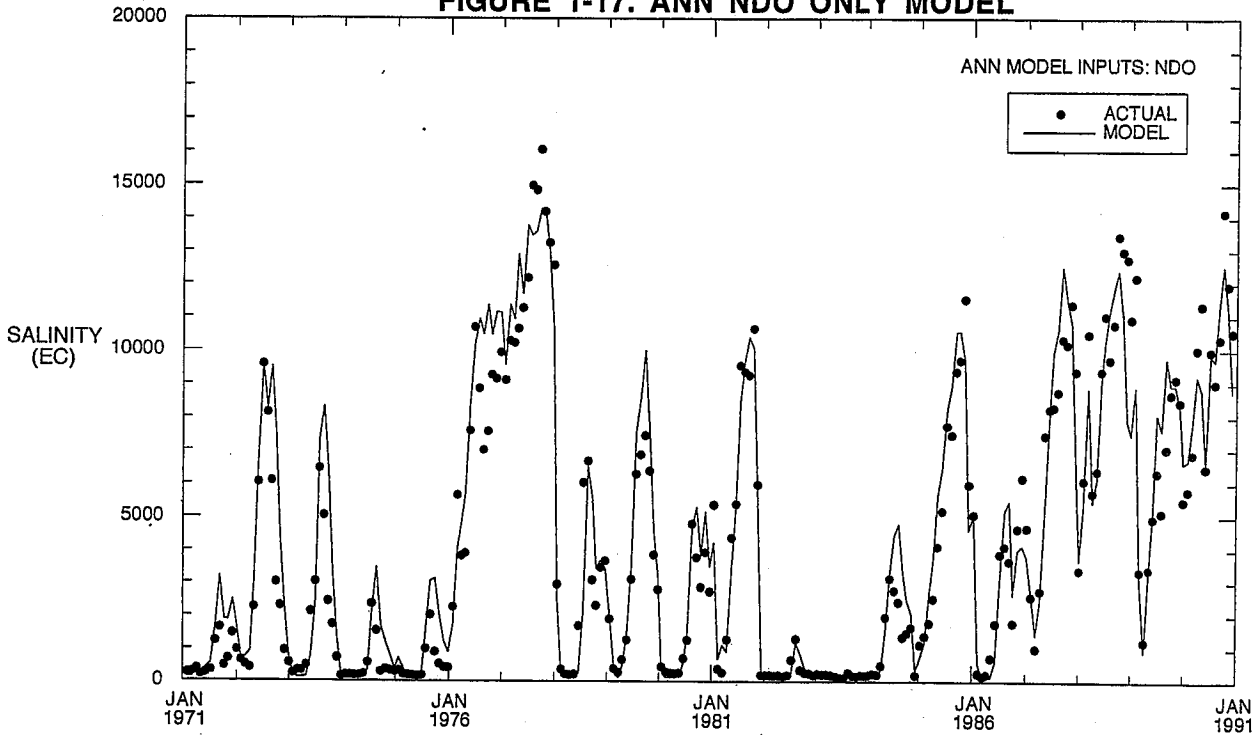

FIGURE 1-17. ANN NDO ONLY MODEL



EMMATON TIME SERIES PLOT HISTORICAL DATA

FIGURE 1-18. ANN MULTIPLE INPUT MODEL

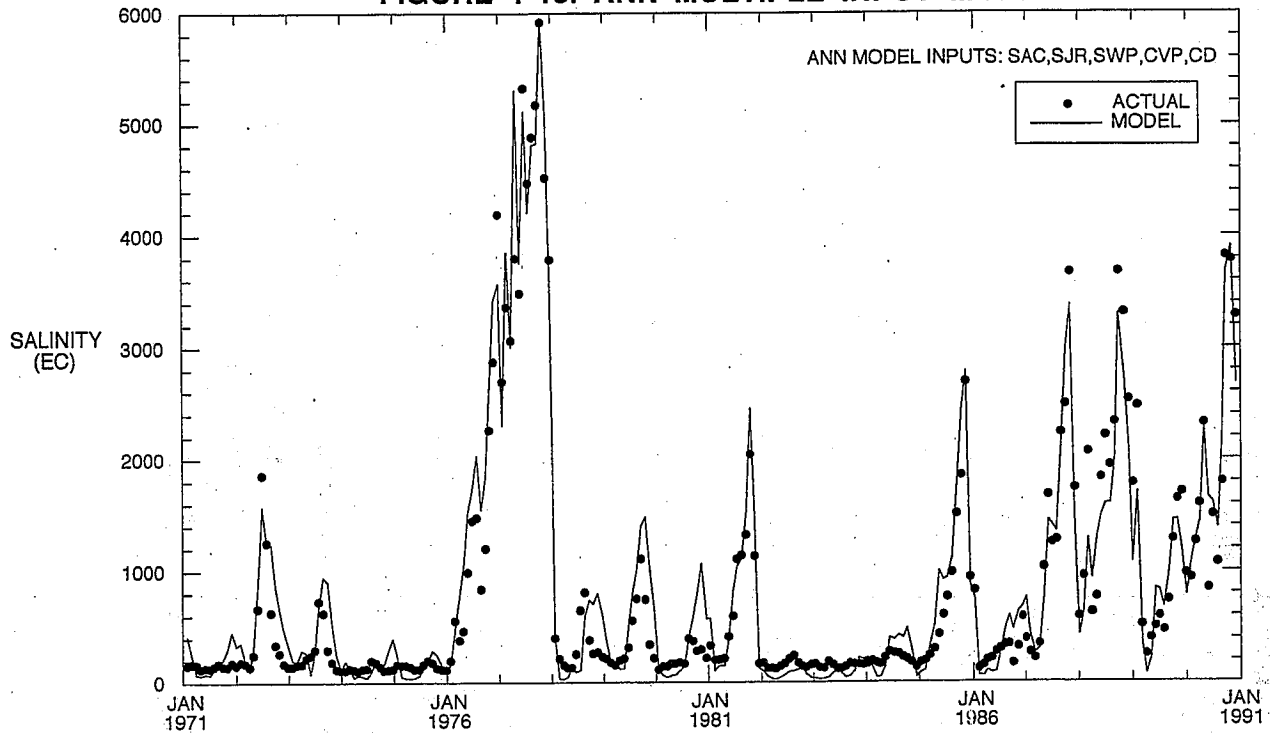
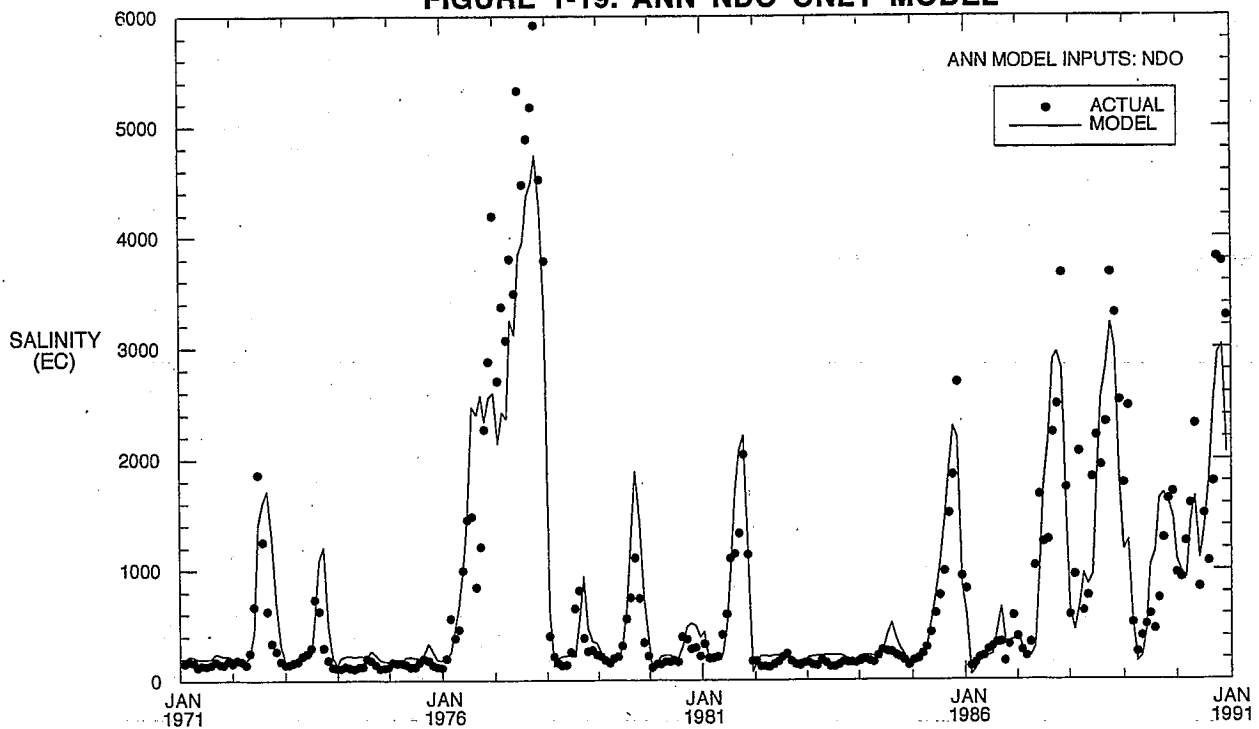

FIGURE 1-19. ANN NDO ONLY MODEL



JERSEY PT TIME SERIES PLOT HISTORICAL DATA

FIGURE 1-20. ANN MULTIPLE INPUT MODEL

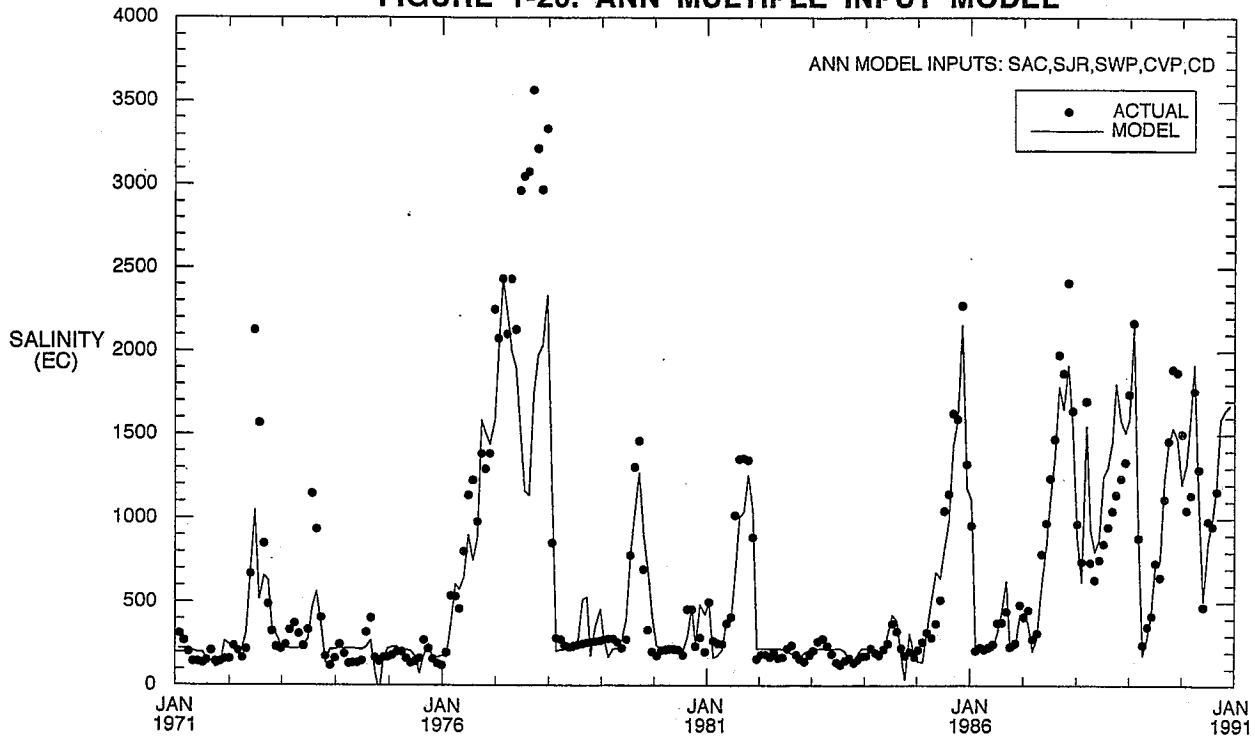
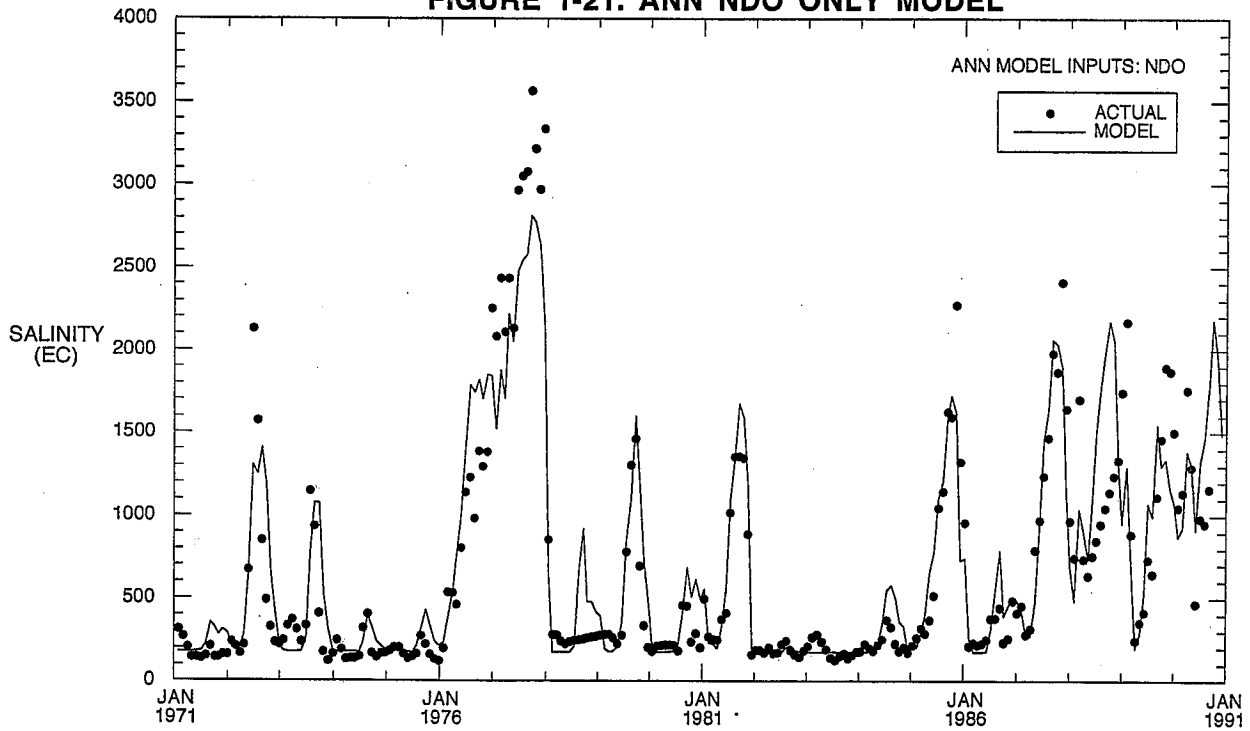

FIGURE 1-21. ANN NDO ONLY MODEL



CONTRA COSTA CANAL TIME SERIES PLOT HISTORICAL DATA

FIGURE 1-22. ANN MULTIPLE INPUT MODEL

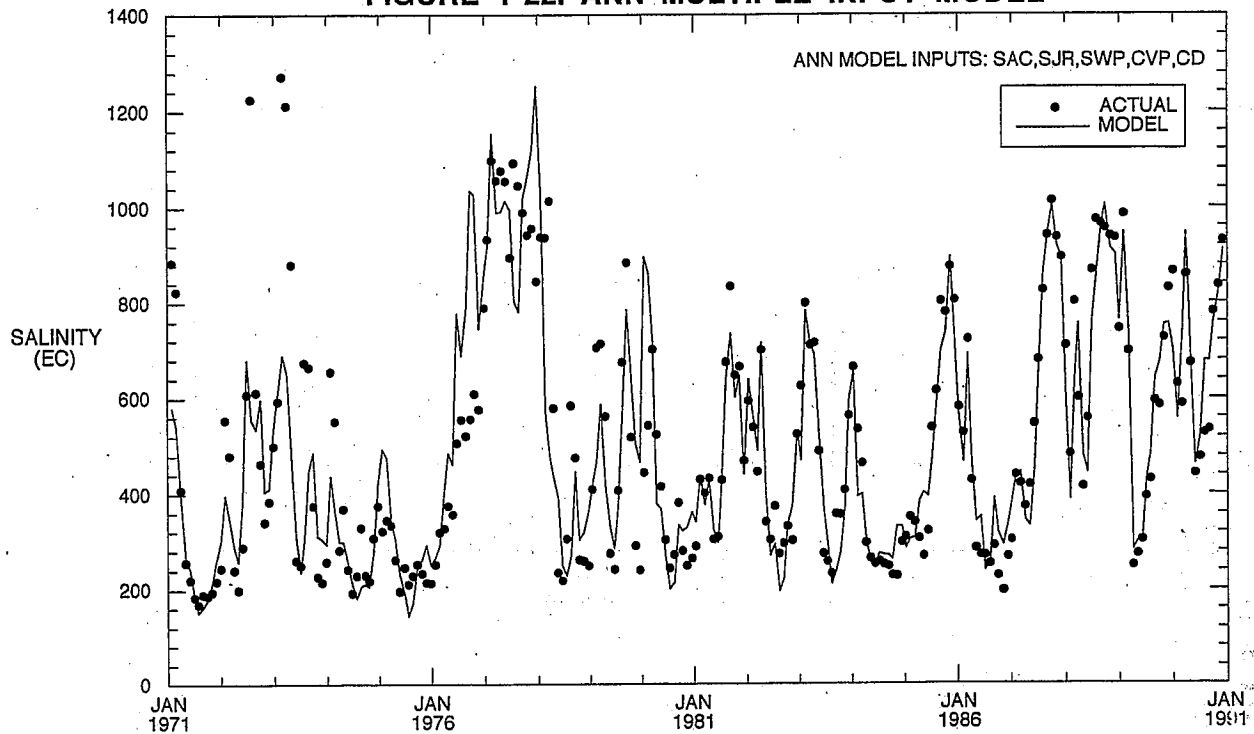
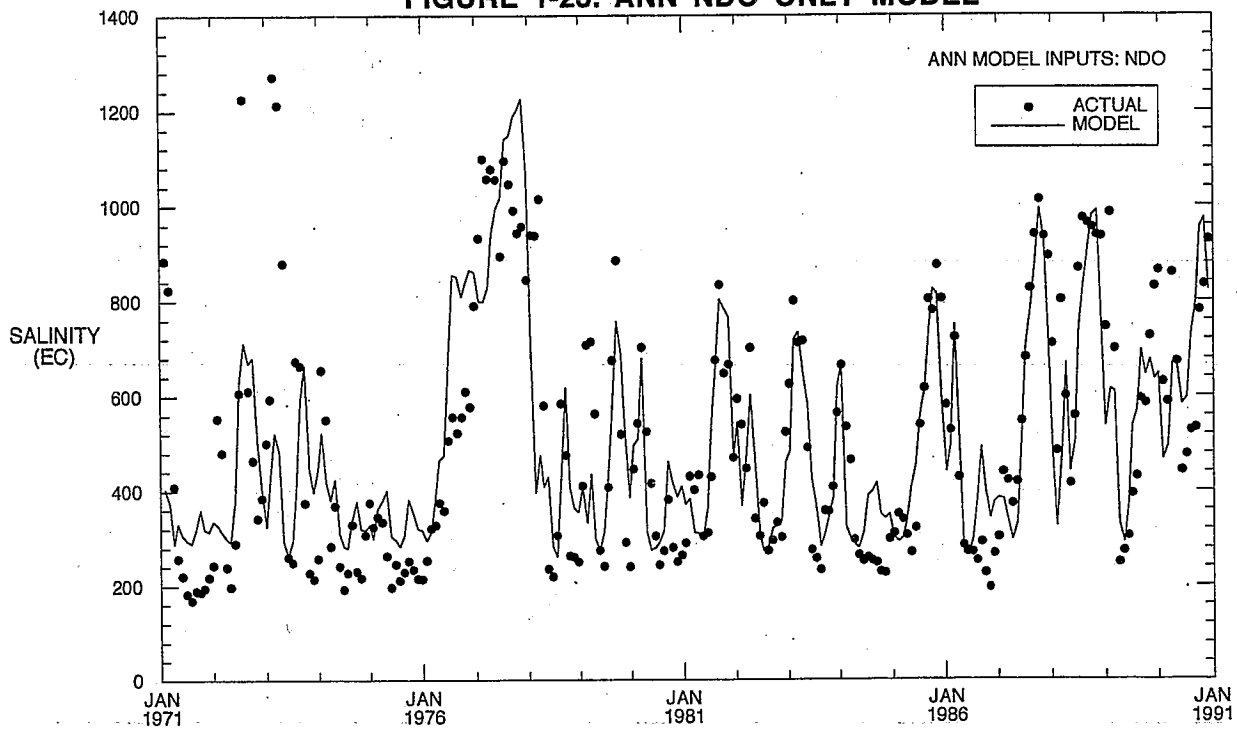

FIGURE 1-23. ANN NDO ONLY MODEL



CLIFTON COURT TIME SERIES PLOT HISTORICAL DATA

FIGURE 1-24. ANN MULTIPLE INPUT MODEL

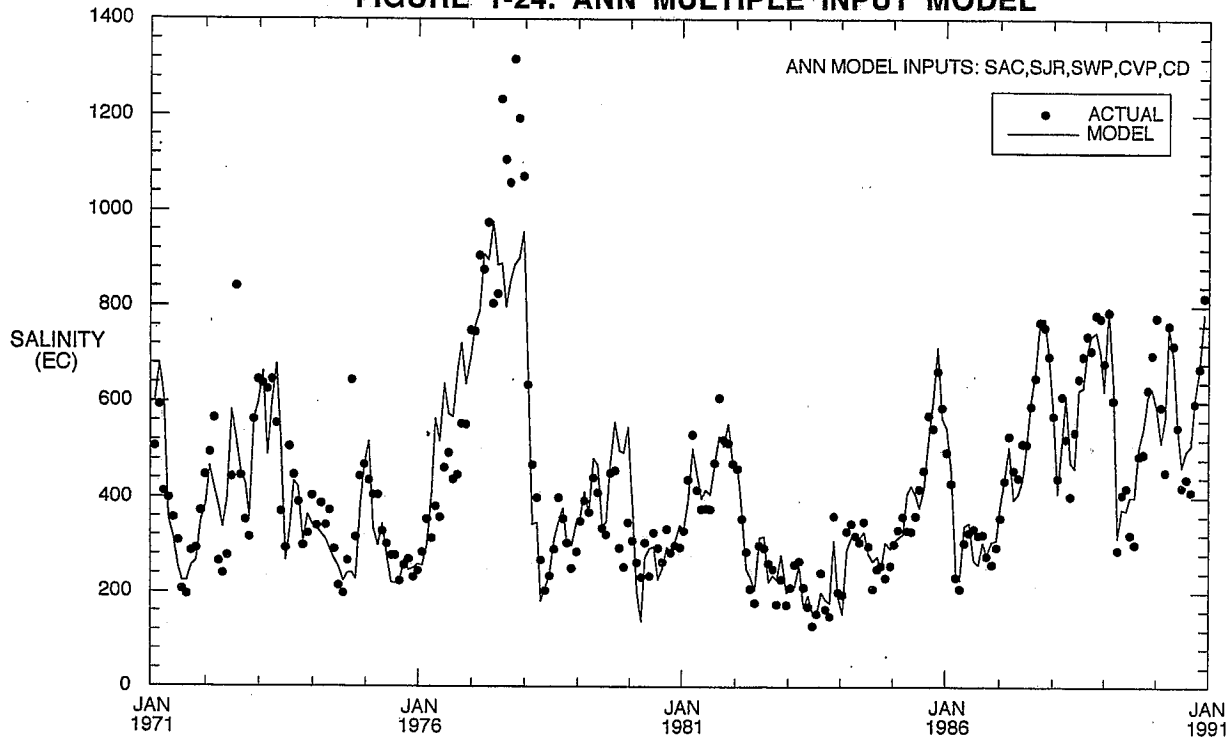
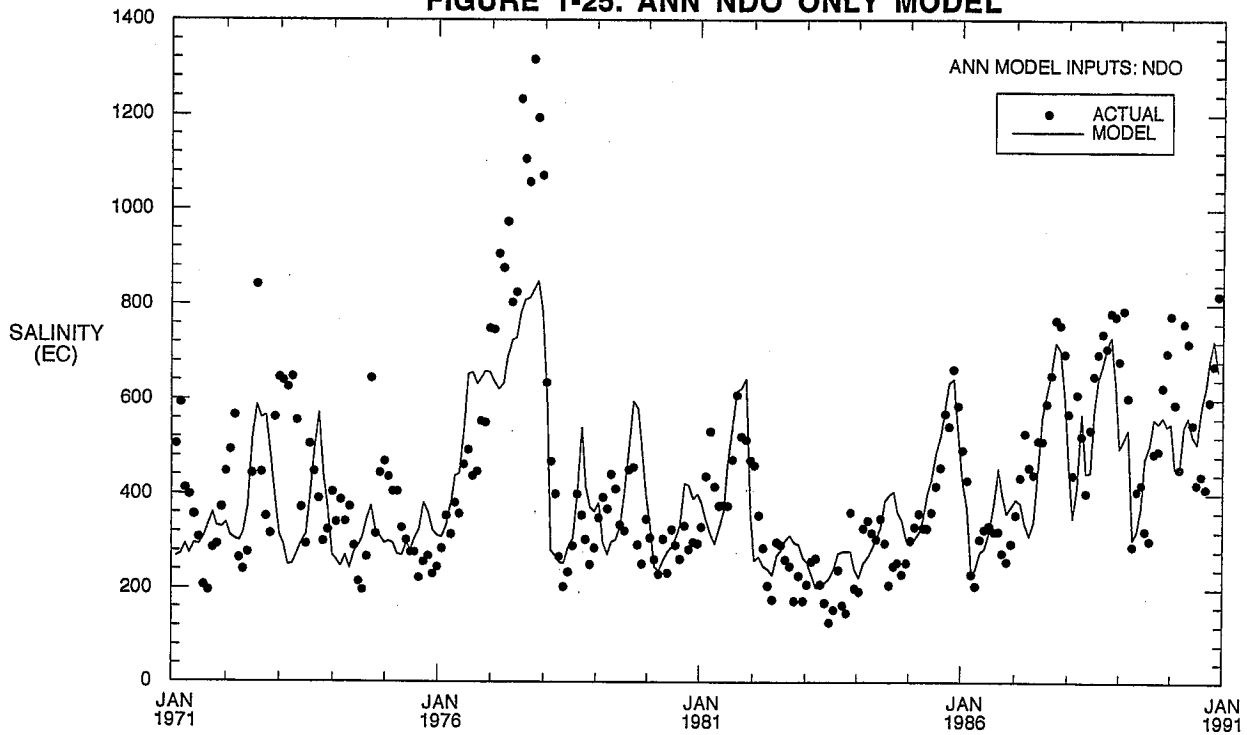

FIGURE 1-25. ANN NDO ONLY MODEL



PITTSBURG TIME SERIES PLOT DSM DATA

FIGURE 1-26. ANN MULTIPLE INPUT MODEL

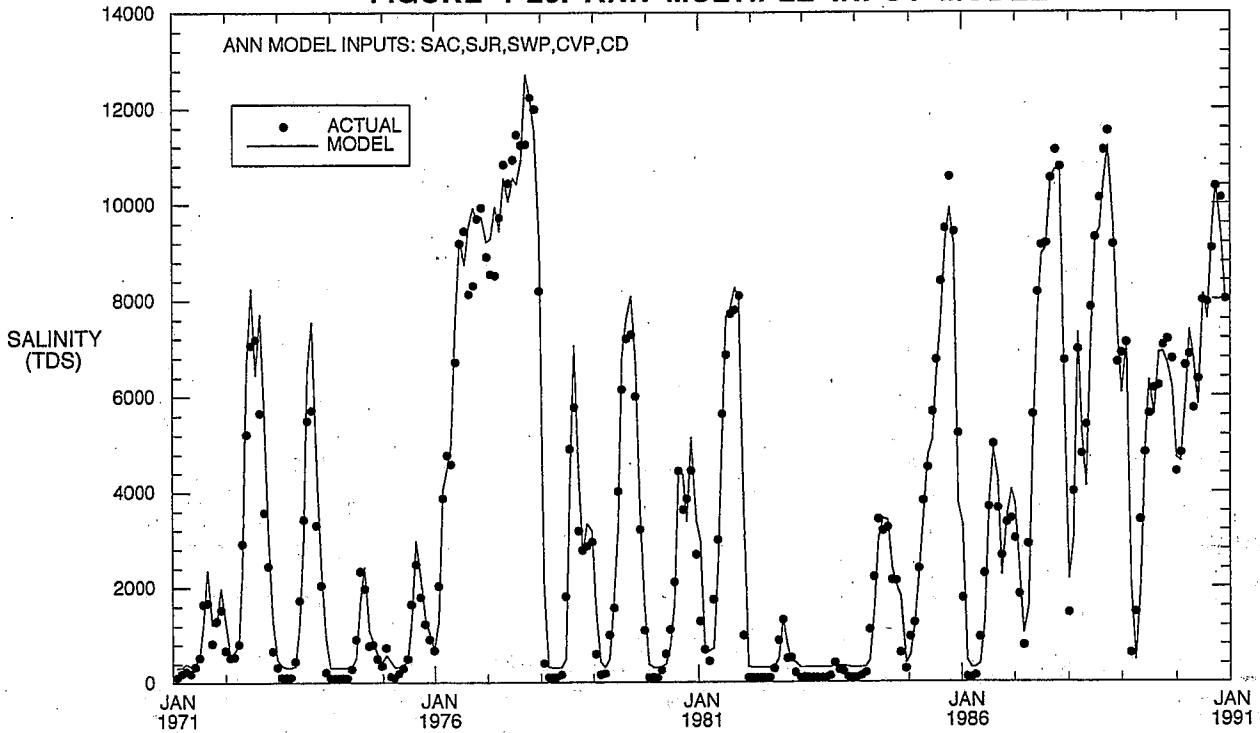
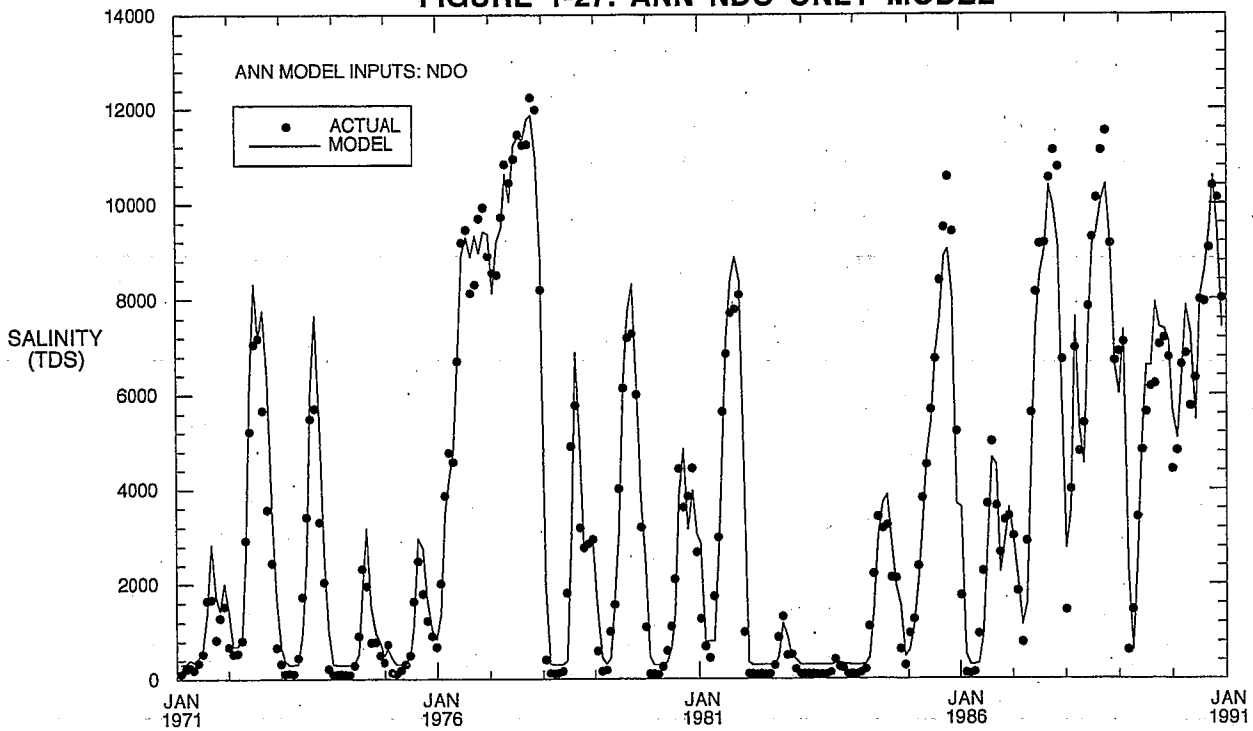

FIGURE 1-27. ANN NDO ONLY MODEL



EMMATON TIME SERIES PLOT DSM DATA

FIGURE 1-28. ANN MULTIPLE INPUT MODEL

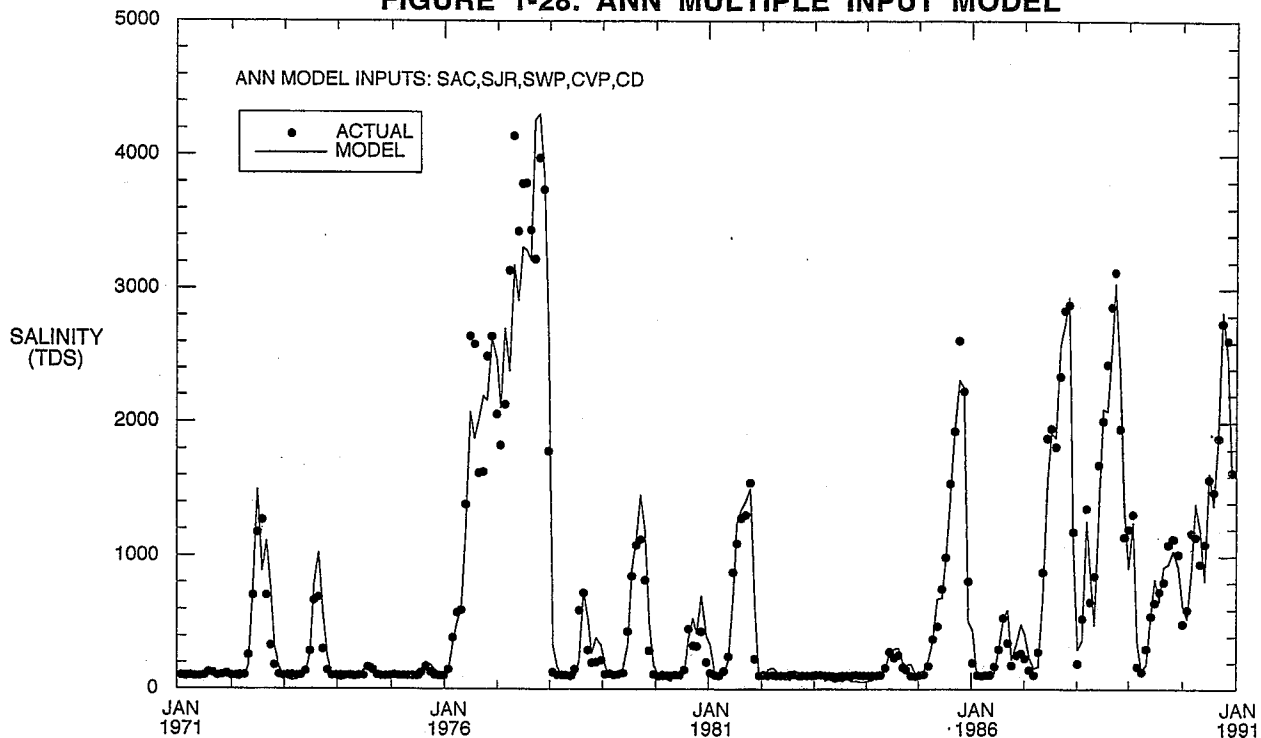
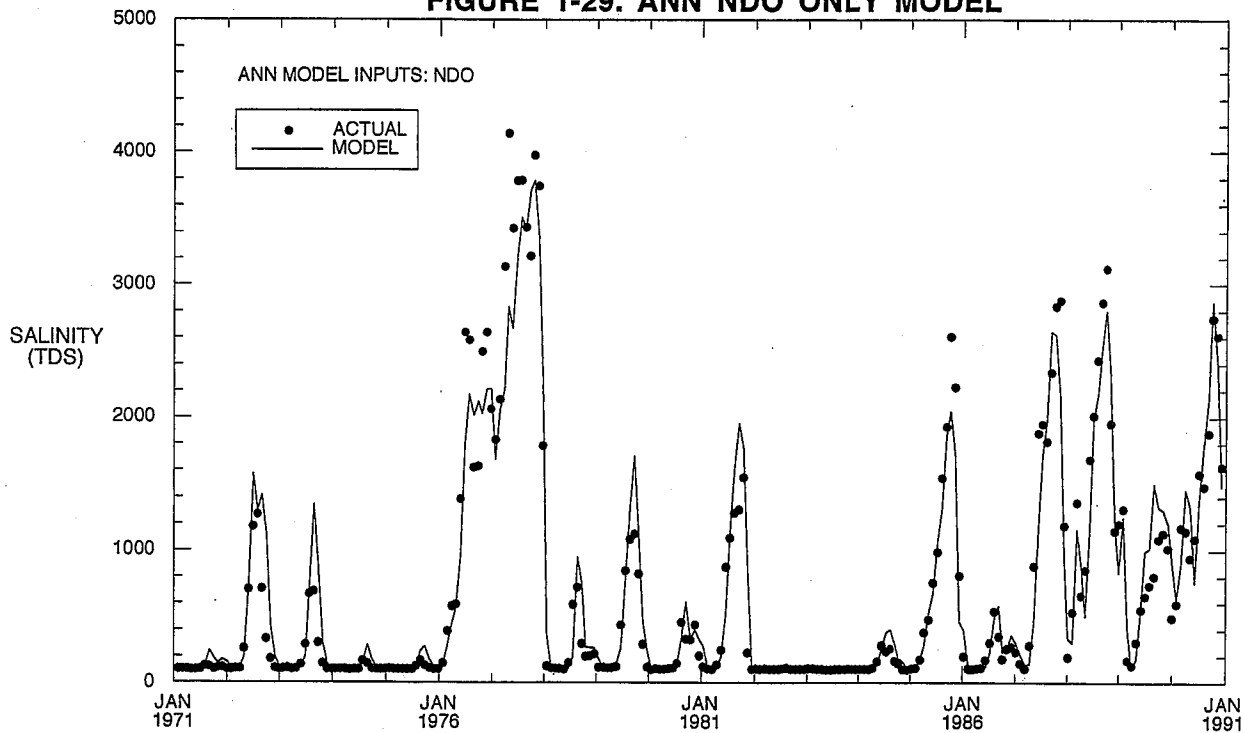

FIGURE 1-29. ANN NDO ONLY MODEL



JERSEY POINT TIME SERIES PLOT DSM DATA

FIGURE 1-30. ANN MULTIPLE INPUT MODEL

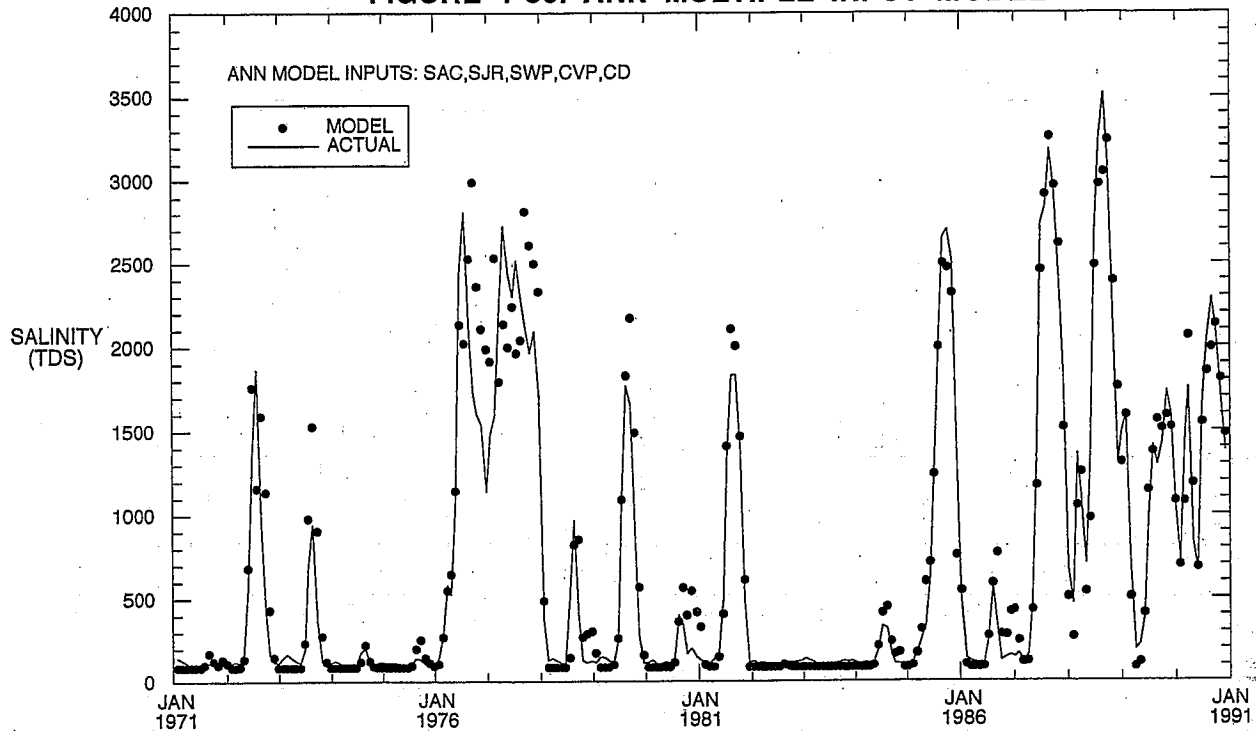
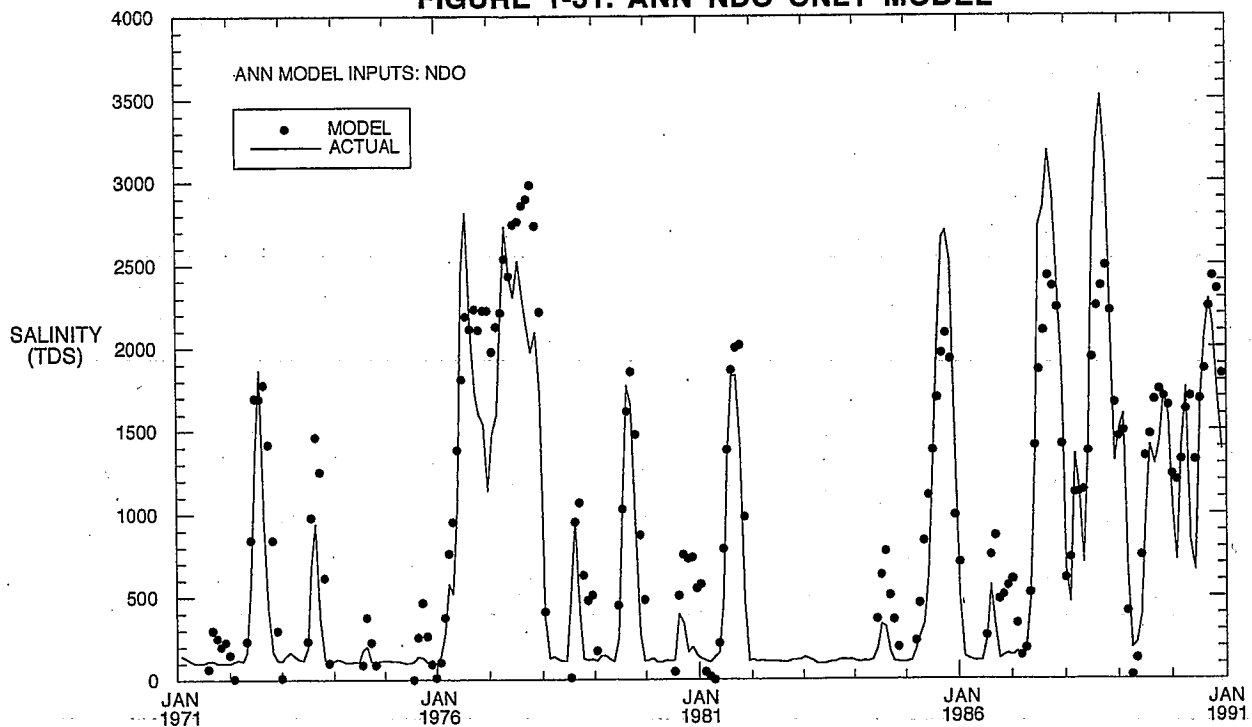

FIGURE 1-31. ANN NDO ONLY MODEL



CONTRA COSTA CANAL TIME SERIES PLOT DSM DATA

FIGURE 1-32. ANN MULTIPLE INPUT MODEL

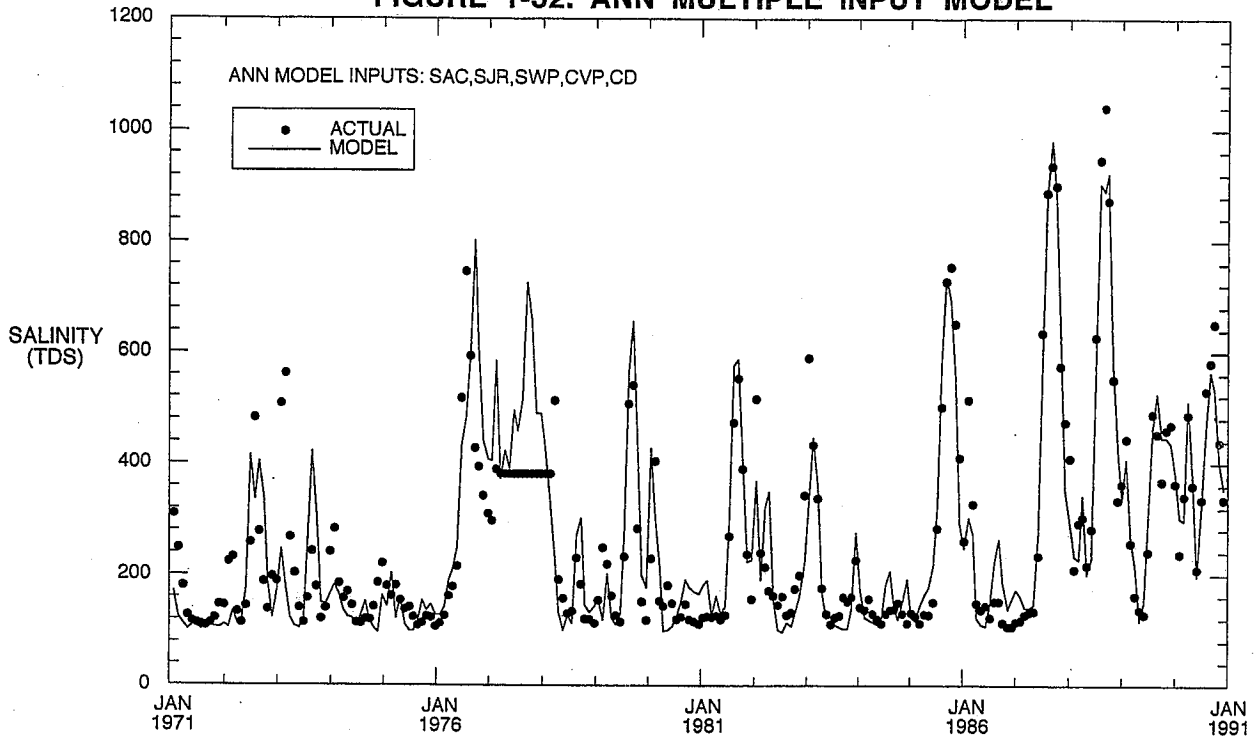
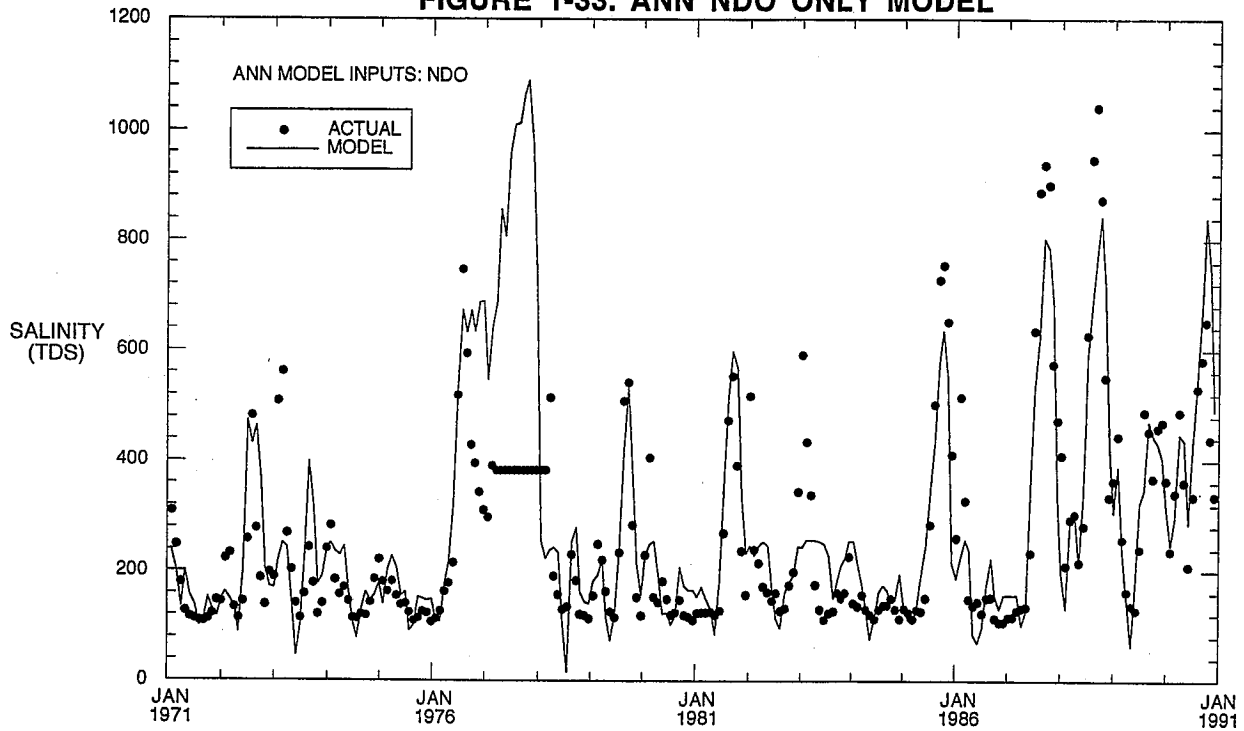

FIGURE 1-33. ANN NDO ONLY MODEL



CLIFTON COURT FOREBAY TIME SERIES PLOT DSM DATA

FIGURE 1-34. ANN MULTIPLE INPUT MODEL

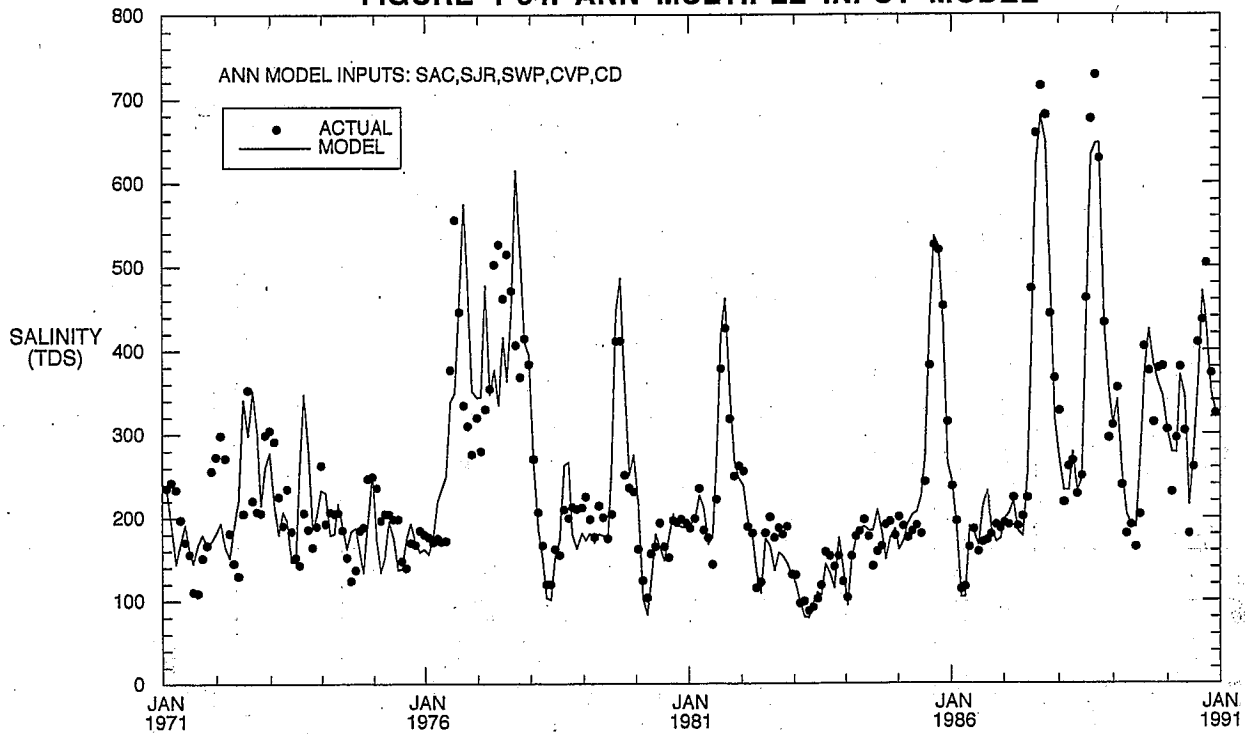

FIGURE 1-35. ANN NDO ONLY MODEL

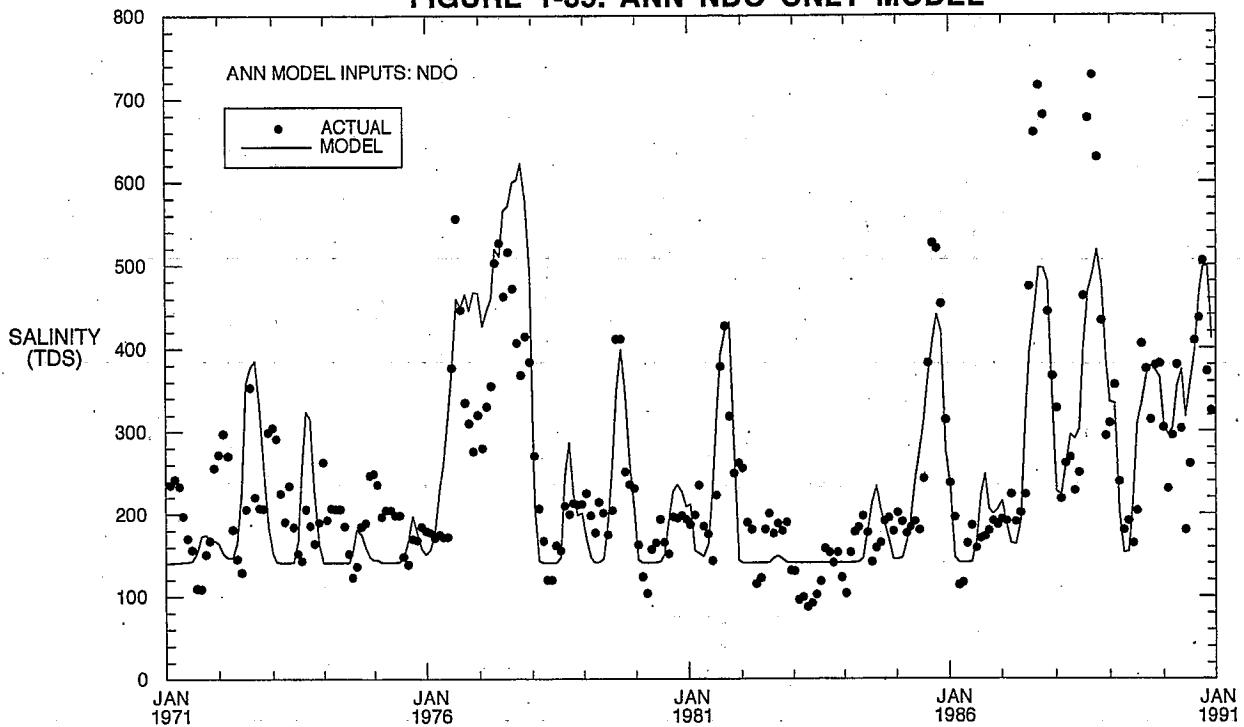
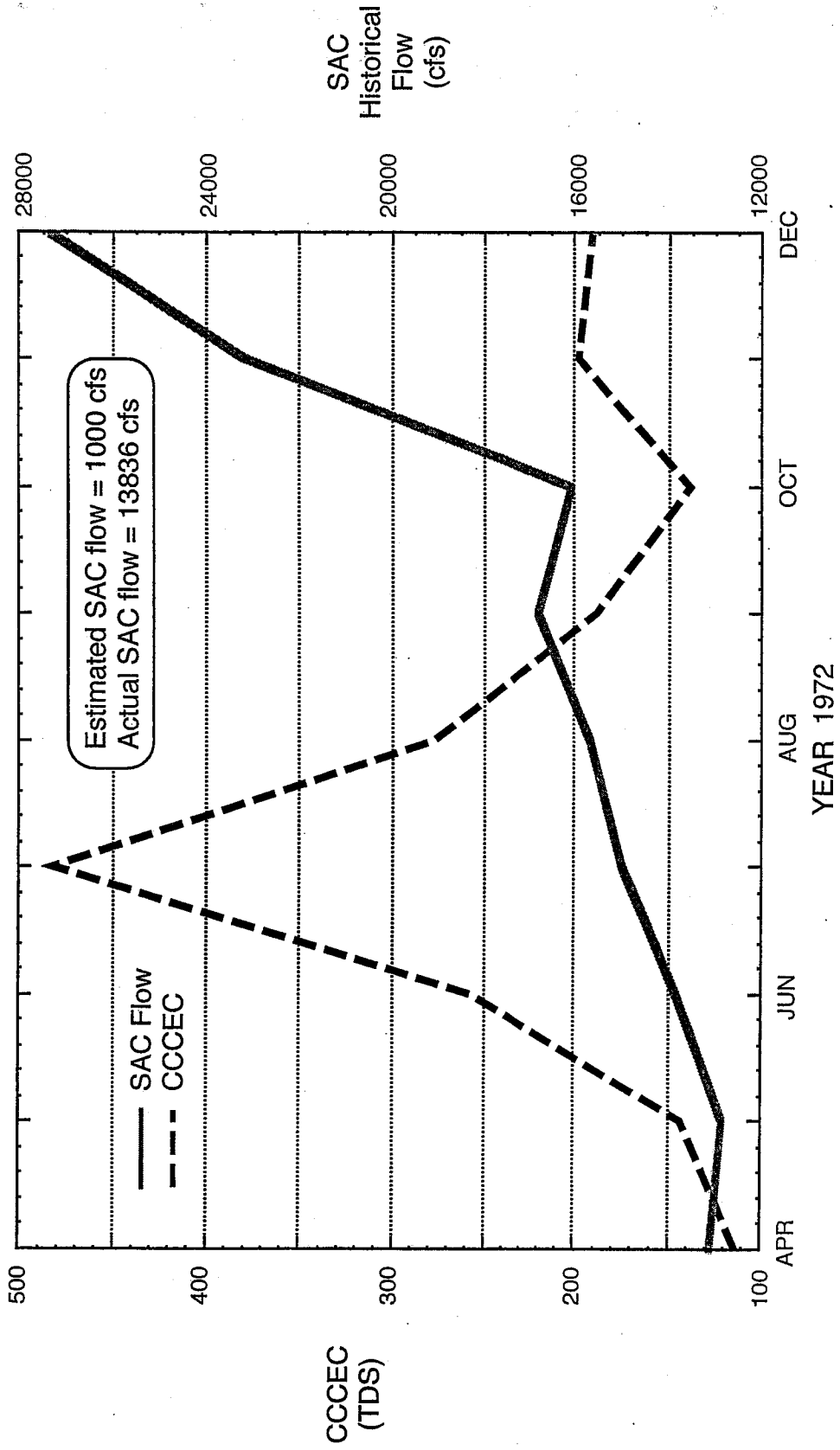

Figure 1-36. Effect of Landsalt on SAC Predictions



SAC PREDICTIONS FROM PITTSBURG SALINITY HISTORICAL DATA

FIGURE 1-37. ANN MULTIPLE INPUT MODEL

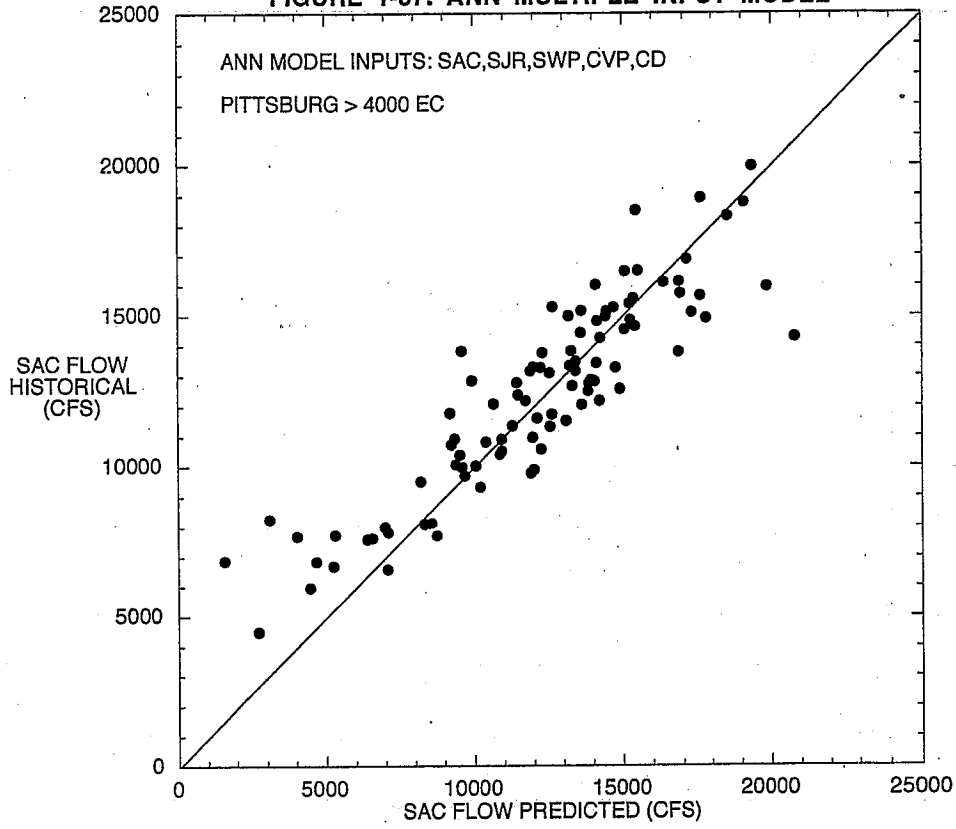
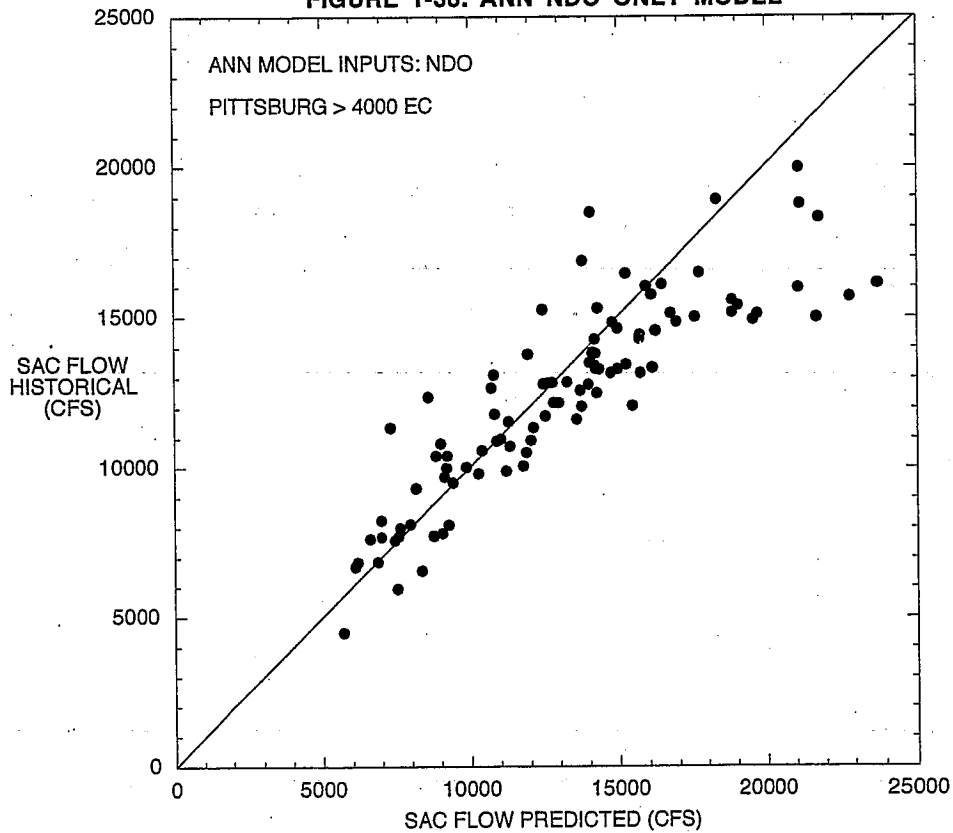

FIGURE 1-38. ANN NDO ONLY MODEL



SAC PREDICTIONS FROM JERSEY POINT SALINITY HISTORICAL DATA

FIGURE 1-39. ANN MULTIPLE INPUT MODEL

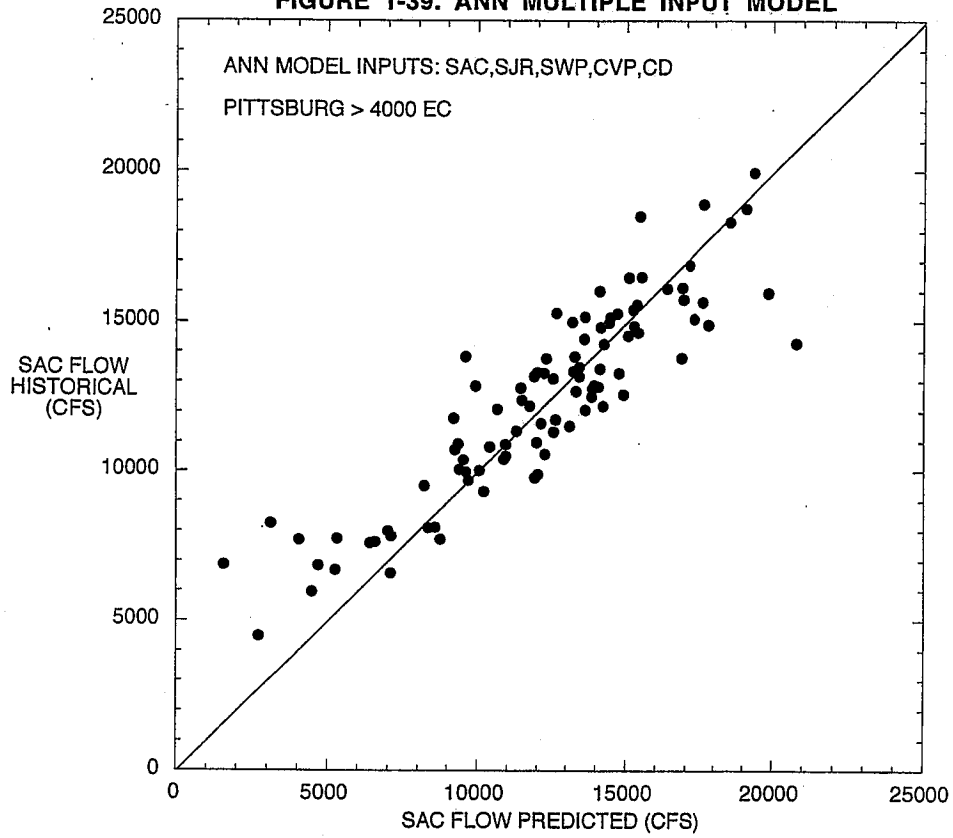
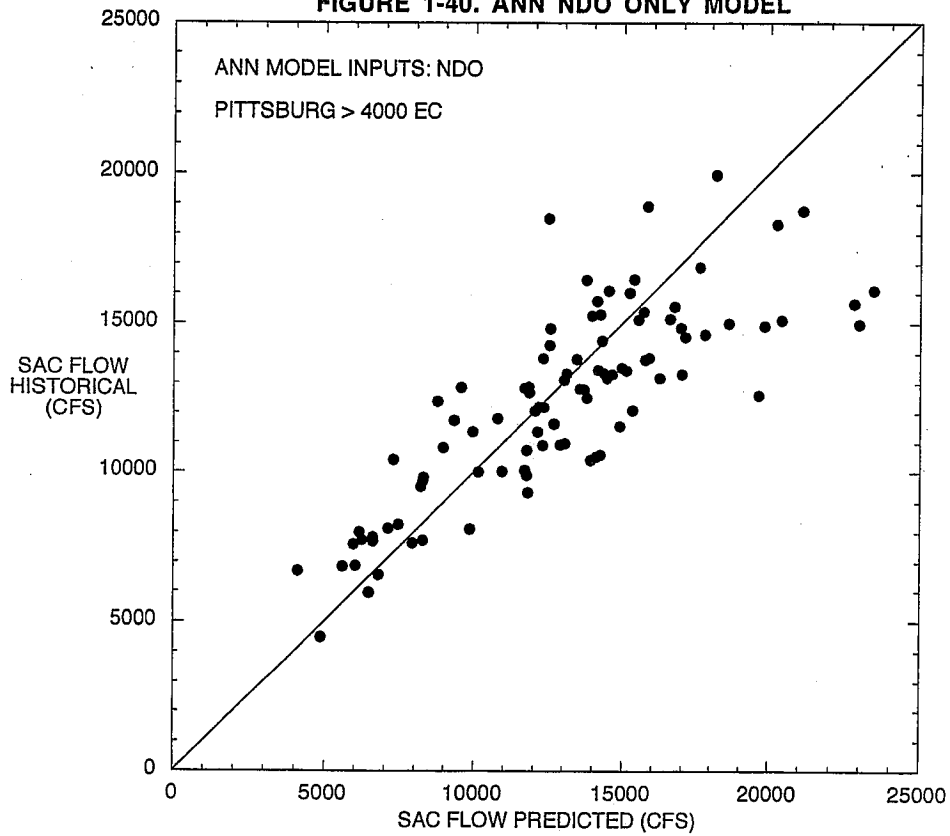

FIGURE 1-40. ANN NDO ONLY MODEL



SAC PREDICTIONS FROM EMMATON SALINITY HISTORICAL DATA

FIGURE 1-41. ANN MULTIPLE INPUT MODEL

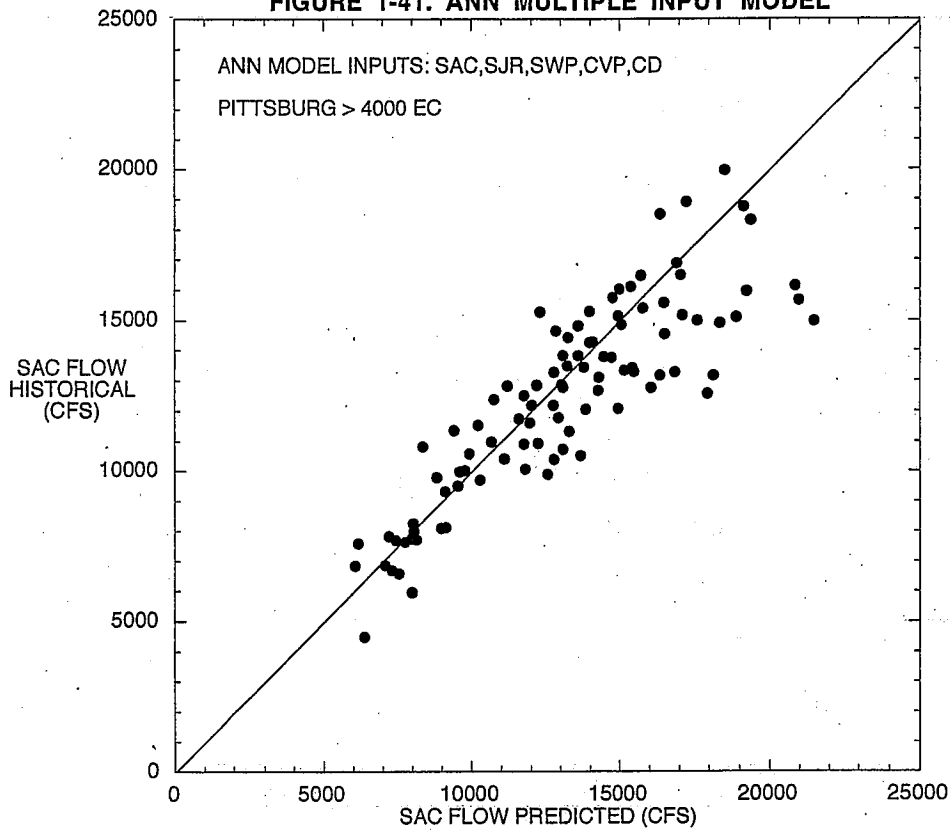
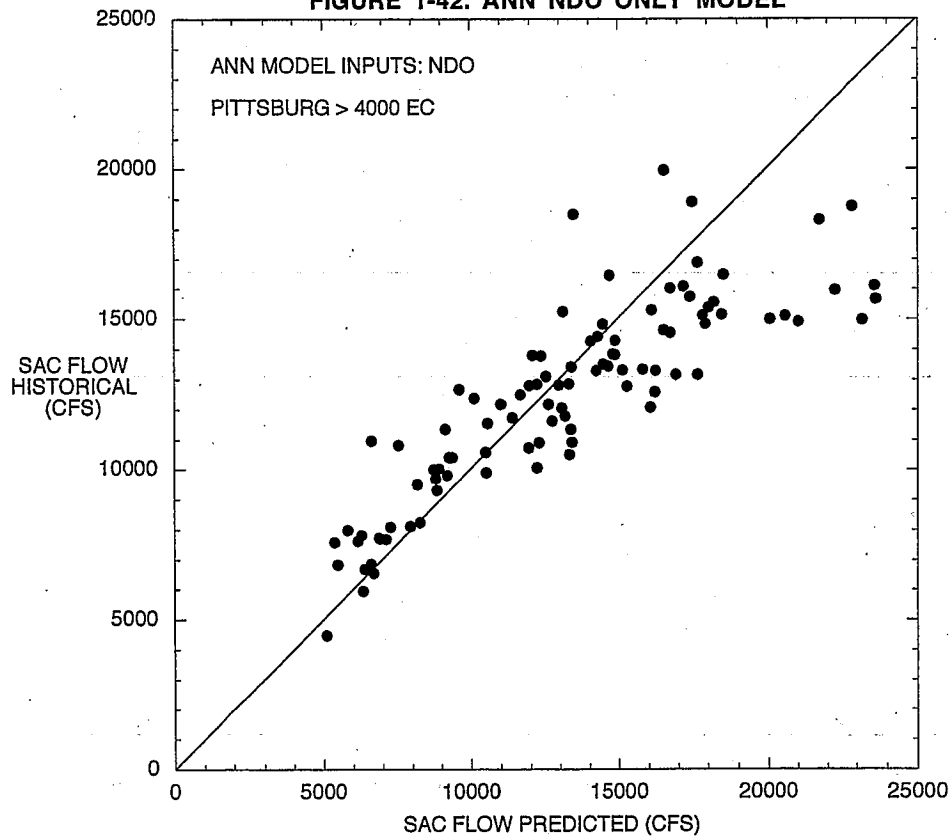

FIGURE 1-42. ANN NDO ONLY MODEL



SAC PREDICTIONS FROM CONTRA COSTA CANAL SALINITY HISTORICAL DATA

FIGURE 1-43. ANN MULTIPLE INPUT MODEL

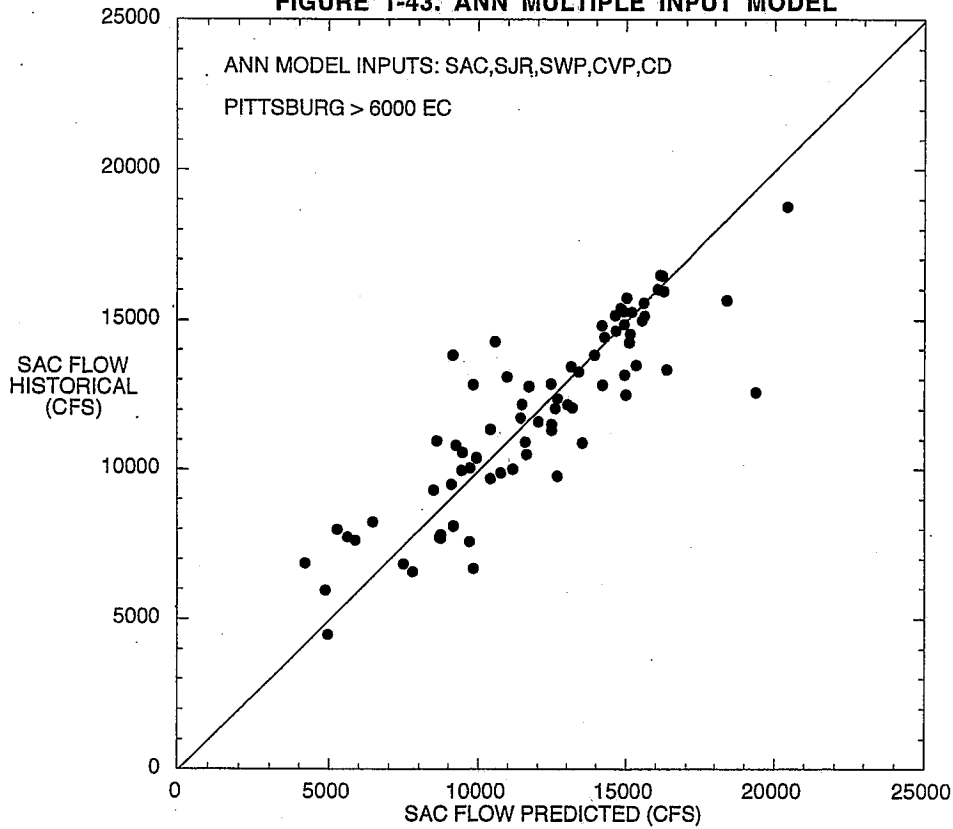
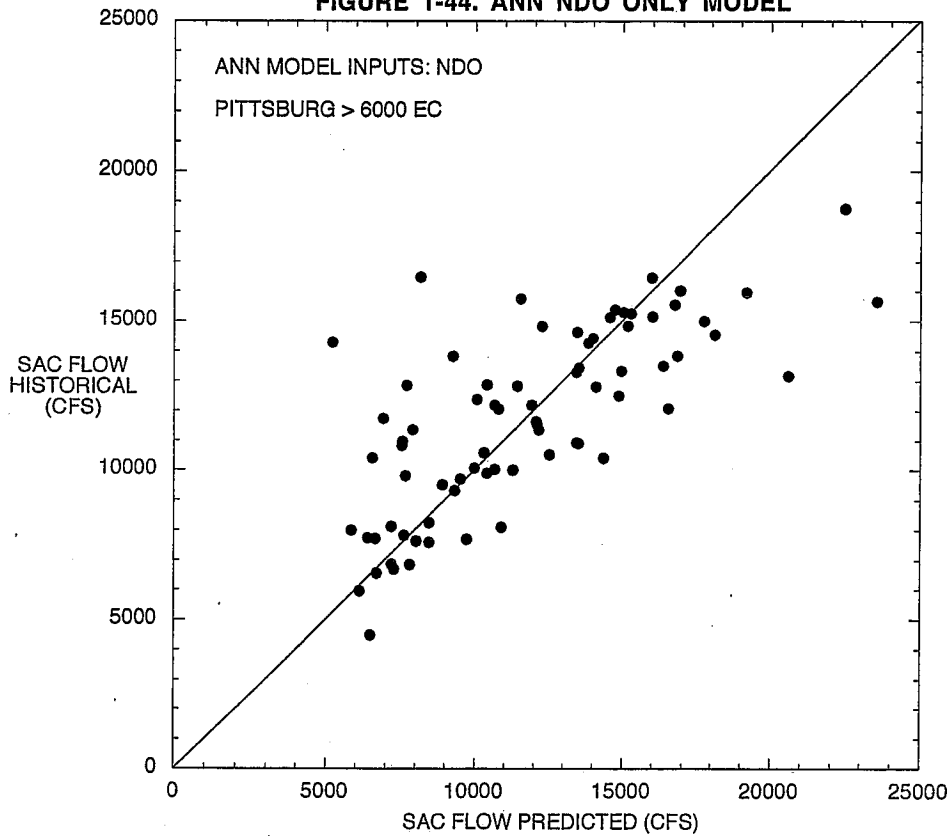

FIGURE 1-44. ANN NDO ONLY MODEL



SAC PREDICTIONS FROM CLIFTON COURT FOREBAY SALINITY HISTORICAL DATA

FIGURE 1-45. ANN MULTIPLE INPUT MODEL

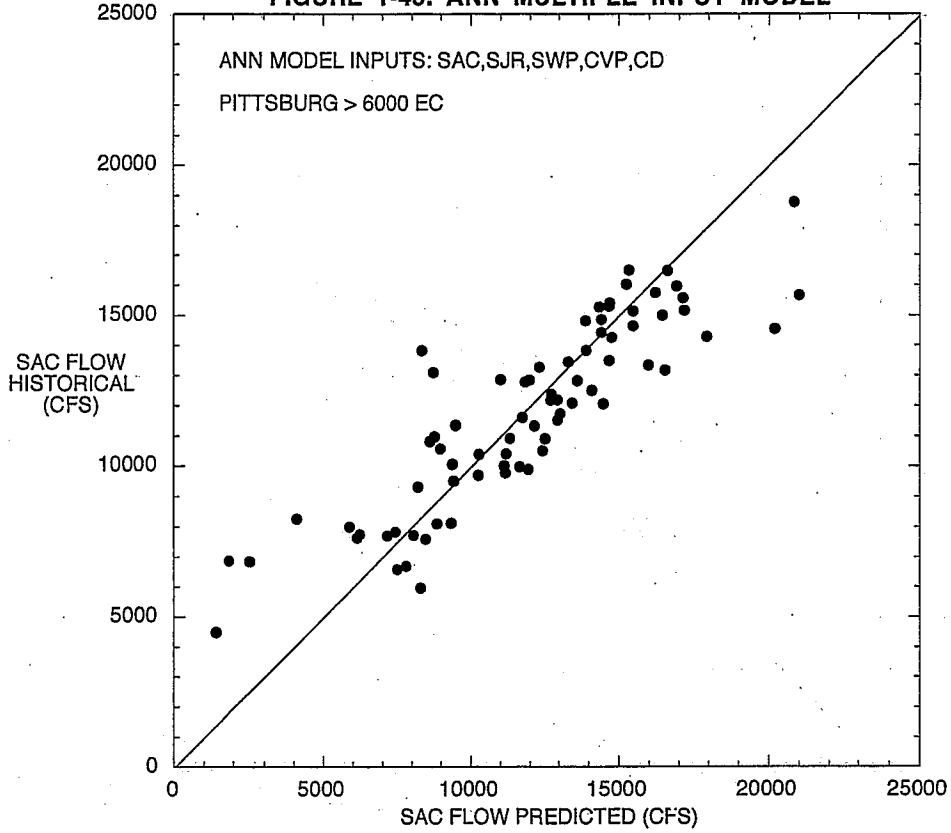
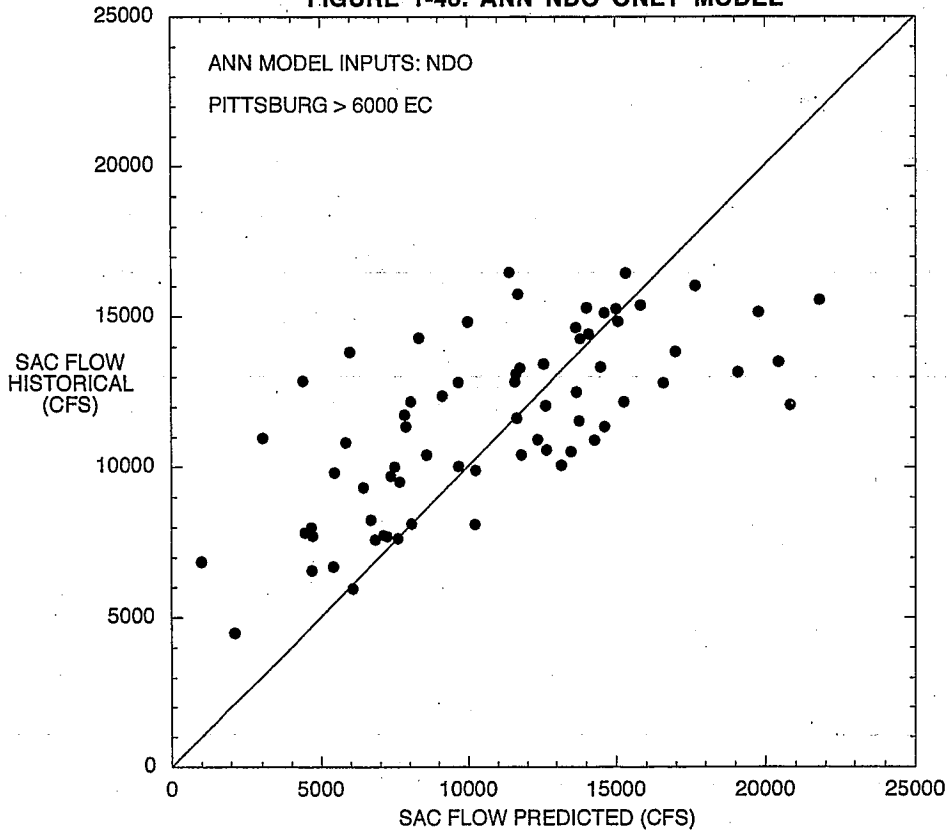

FIGURE 1-46. ANN NDO ONLY MODEL



SAC PREDICTIONS FROM PITTSBURG SALINITY DSM DATA

FIGURE 1-47: ANN MULTIPLE INPUT MODEL

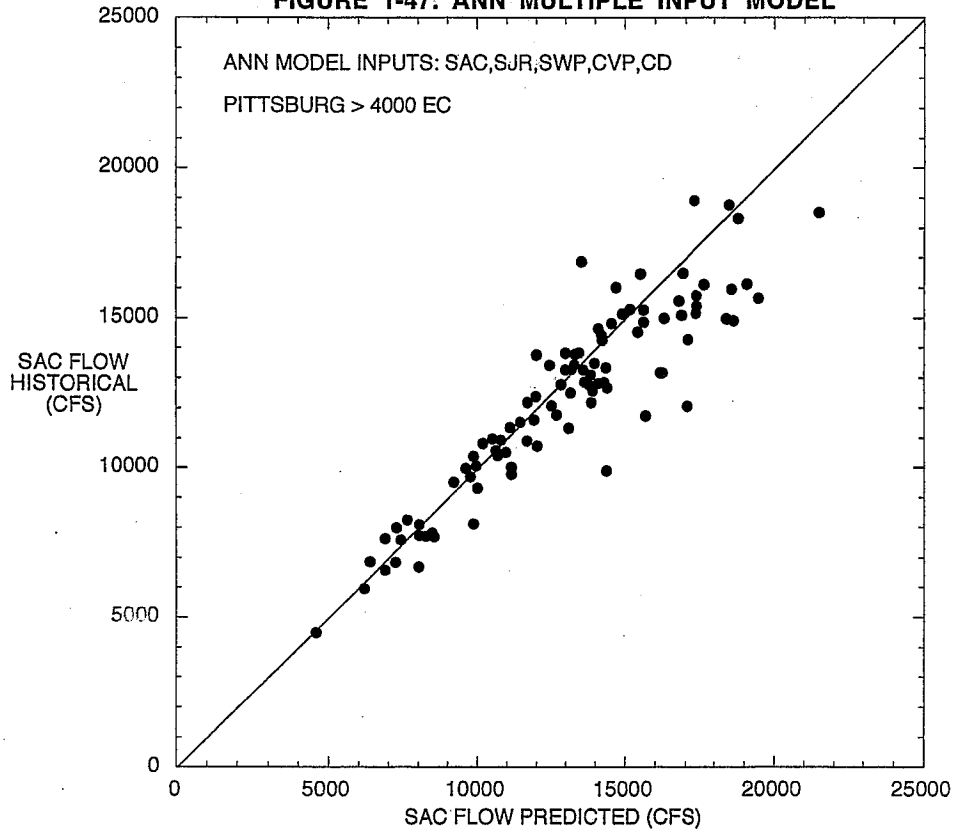
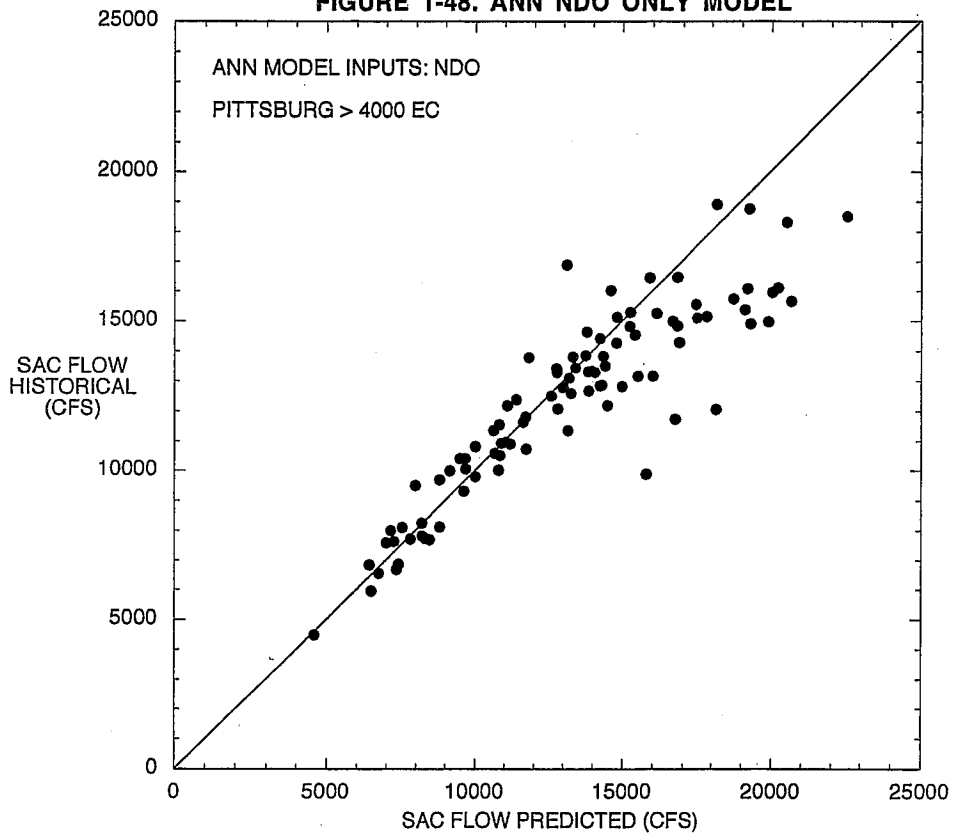

FIGURE 1-48: ANN NDO ONLY MODEL



SAC PREDICTIONS FROM EMMATON SALINITY DSM DATA

FIGURE 1-49. ANN MULTIPLE INPUT MODEL

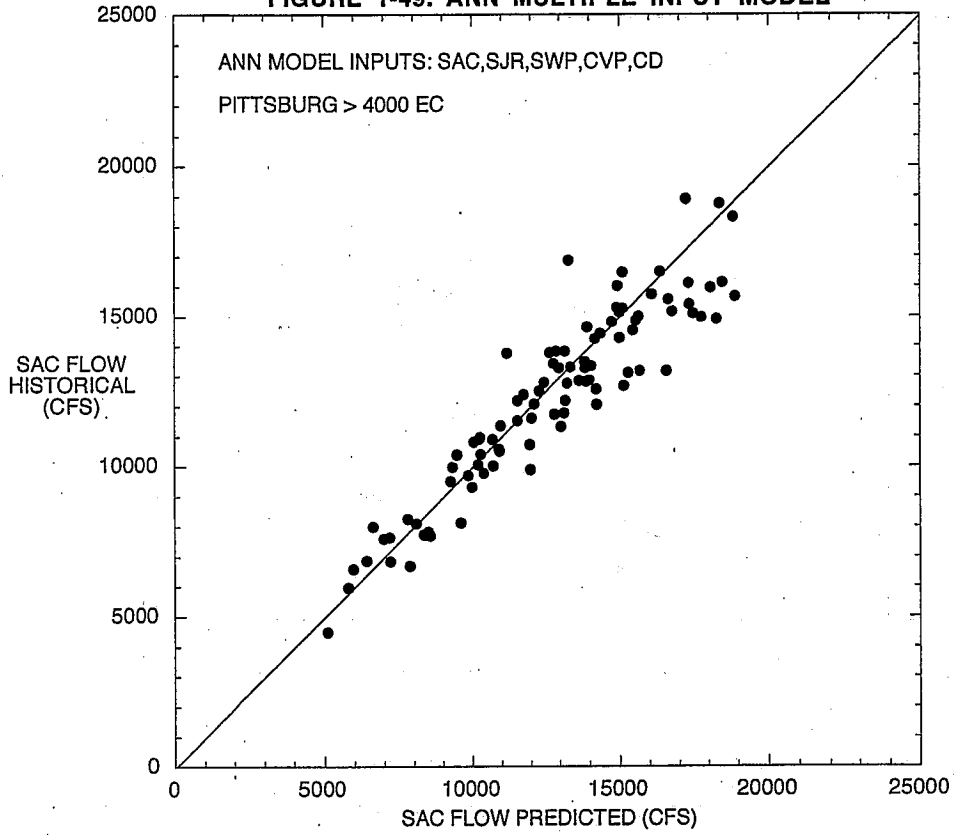
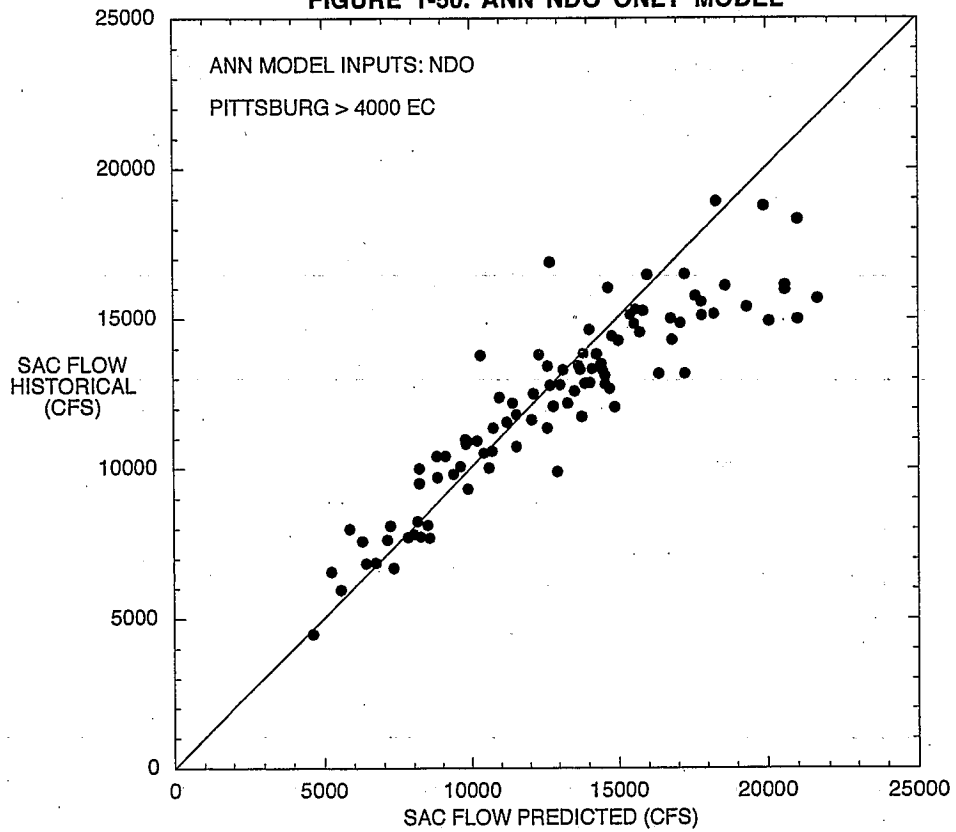

FIGURE 1-50. ANN NDO ONLY MODEL



SAC PREDICTIONS FROM JERSEY POINT SALINITY DSM DATA

FIGURE 1-51. ANN MULTIPLE INPUT MODEL

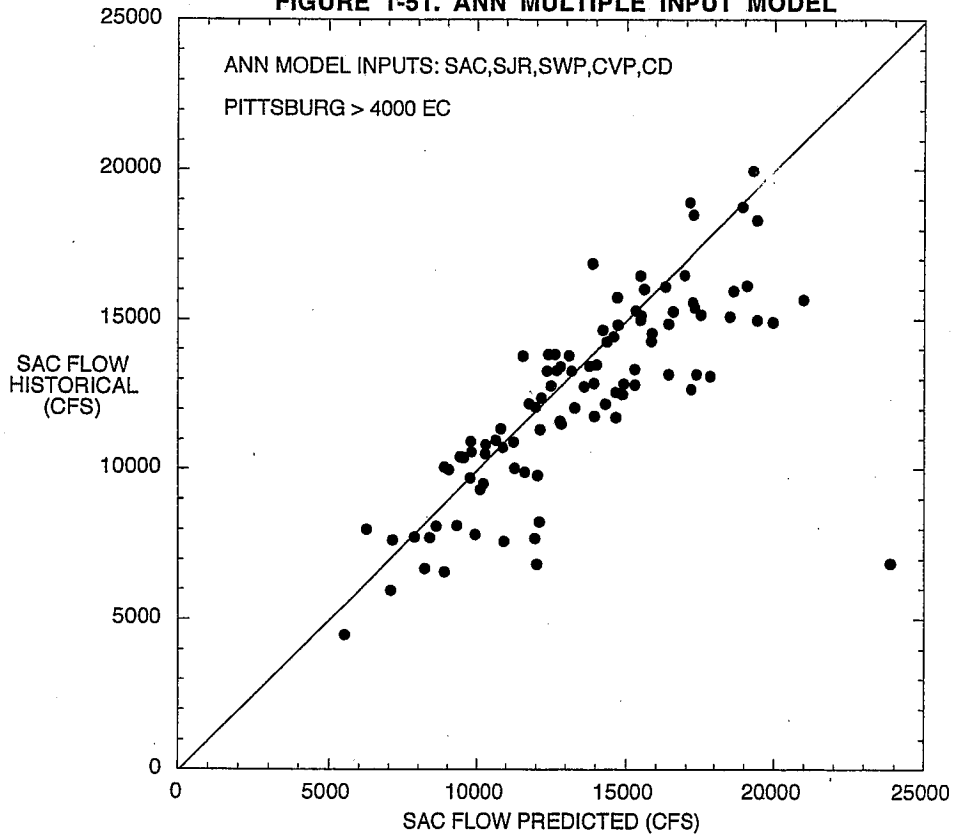
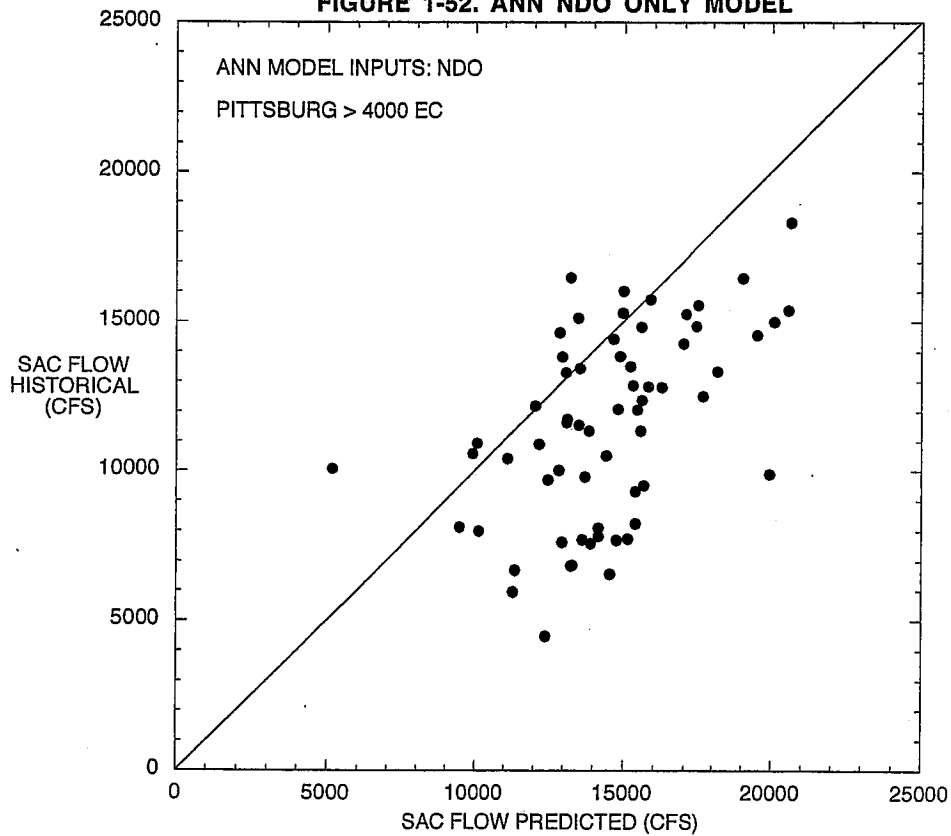

FIGURE 1-52. ANN NDO ONLY MODEL



SAC PREDICTIONS FROM CONTRA COSTA CANAL SALINITY DSM DATA

FIGURE 1-53. ANN MULTIPLE INPUT MODEL

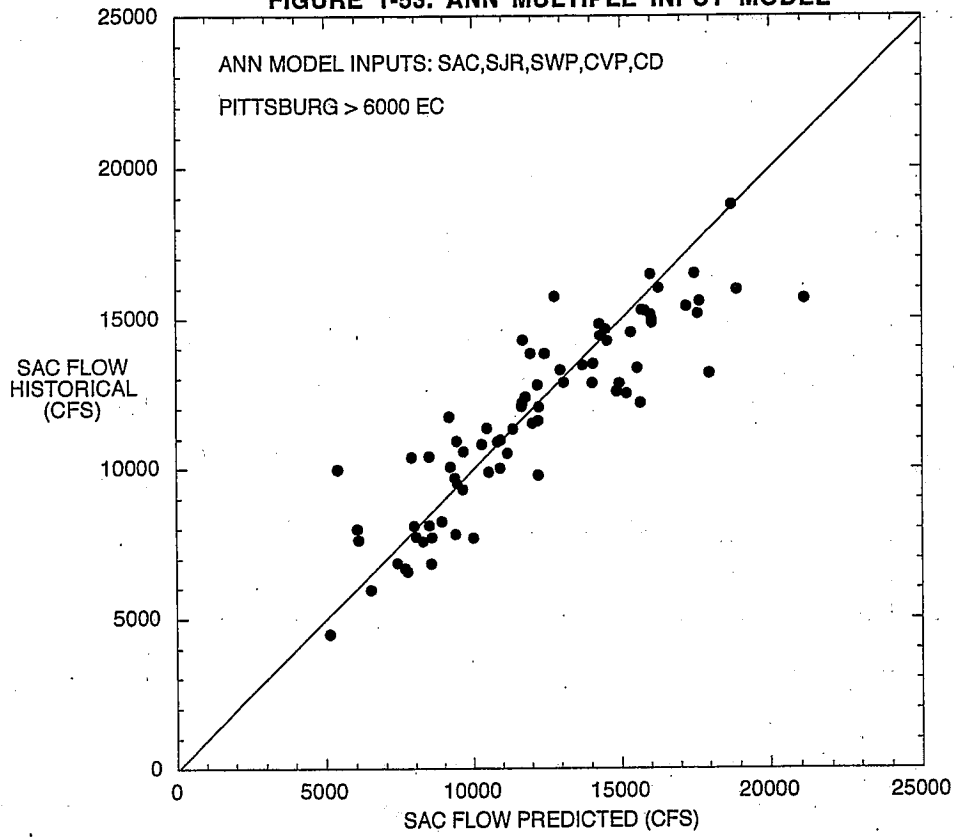
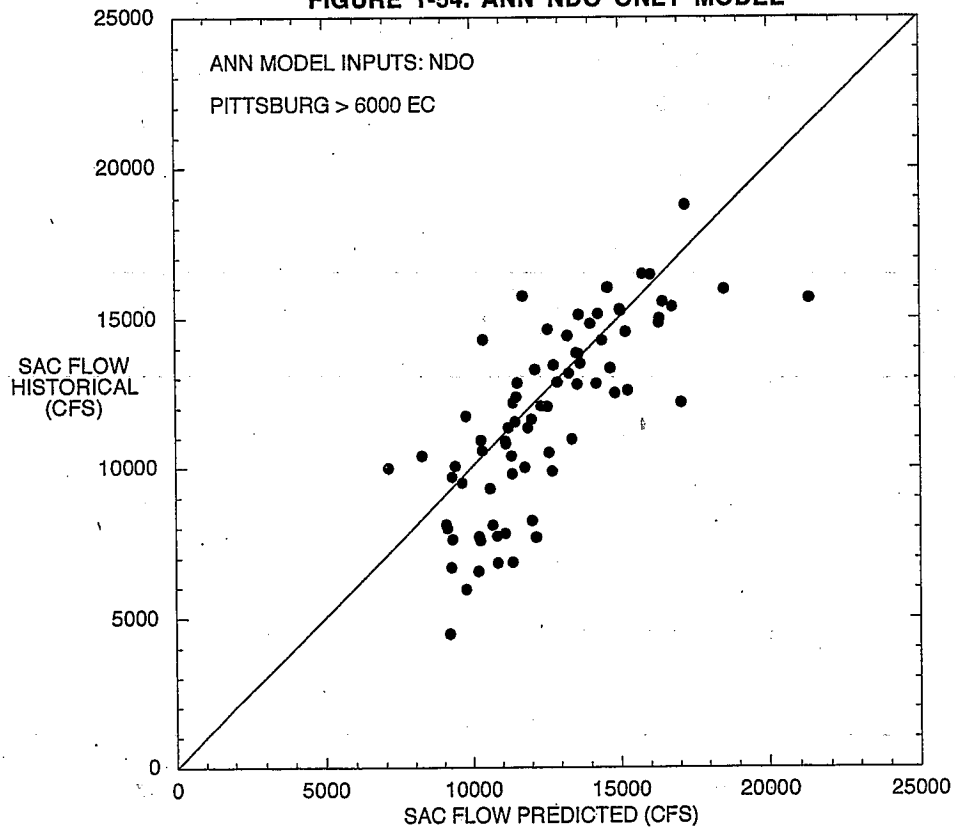

FIGURE 1-54. ANN NDO ONLY MODEL



SAC PREDICTIONS FROM CLIFTON COURT FOREBAY SALINITY DSM DATA

FIGURE 1-55. ANN MULTIPLE INPUT MODEL

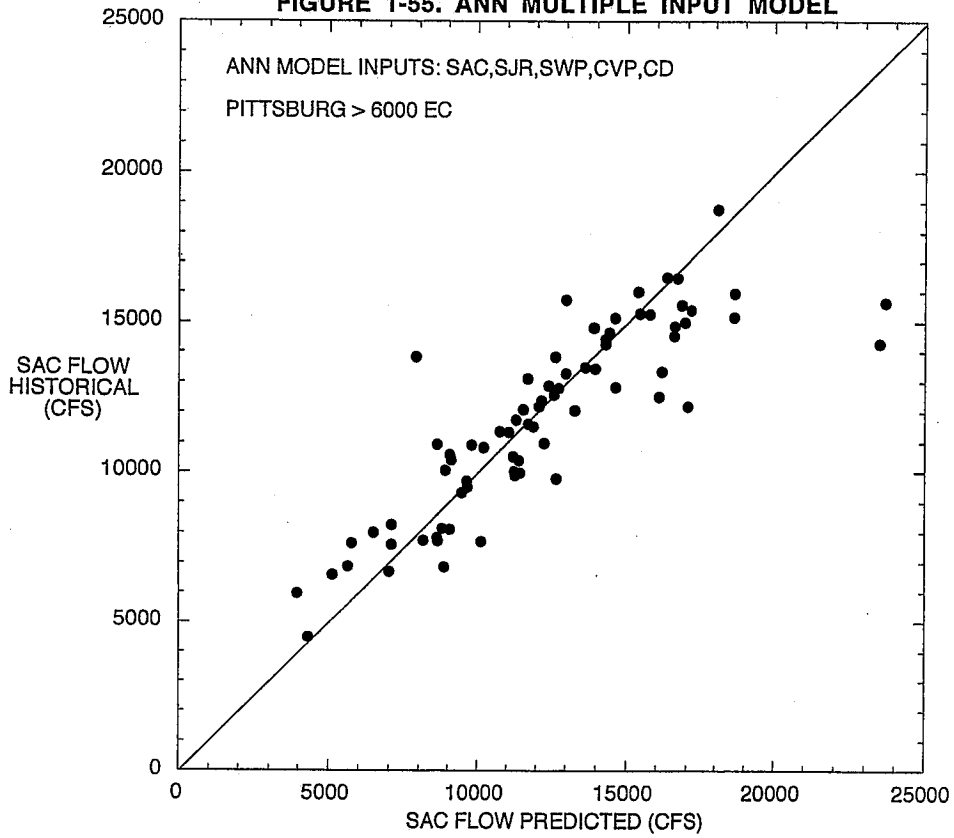
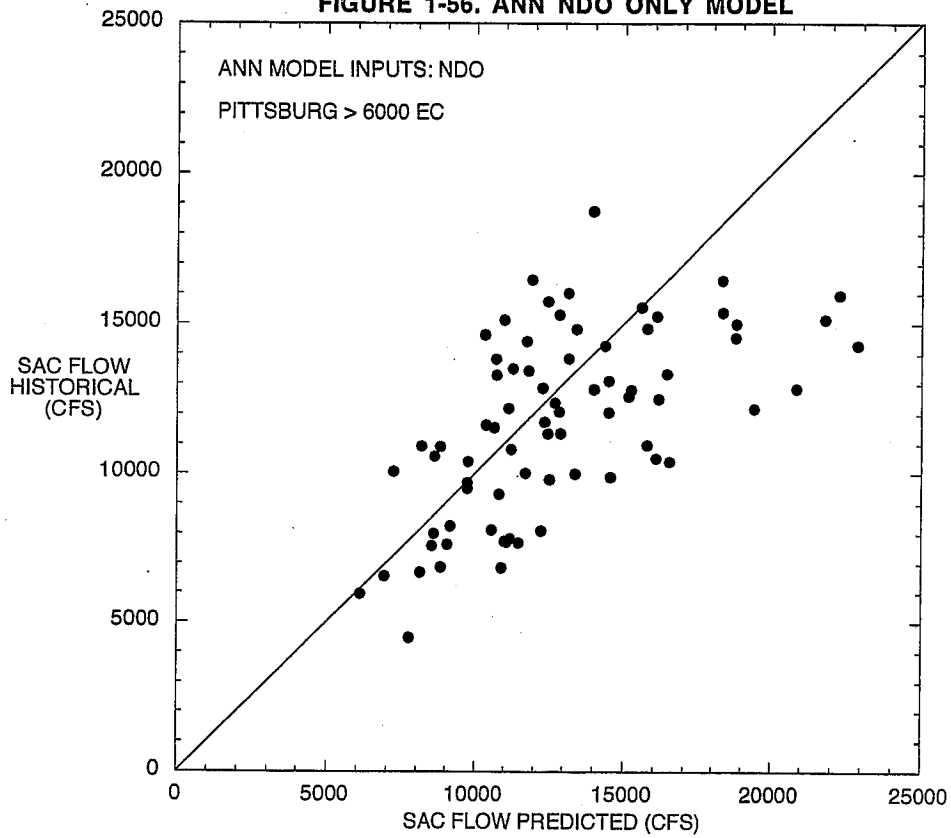

FIGURE 1-56. ANN NDO ONLY MODEL



SAC PREDICTIONS FROM PITTSBURG SIMULATED SALINITY HISTORICAL DATA

FIGURE 1-57. ANN MULTIPLE INPUT MODEL

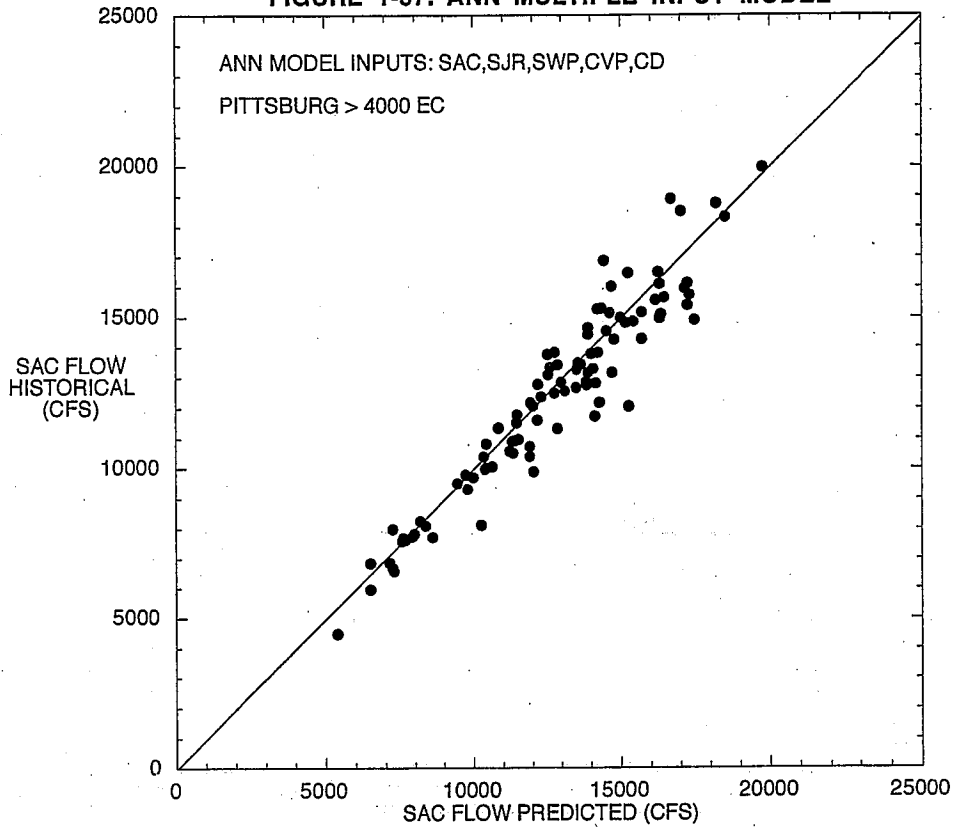
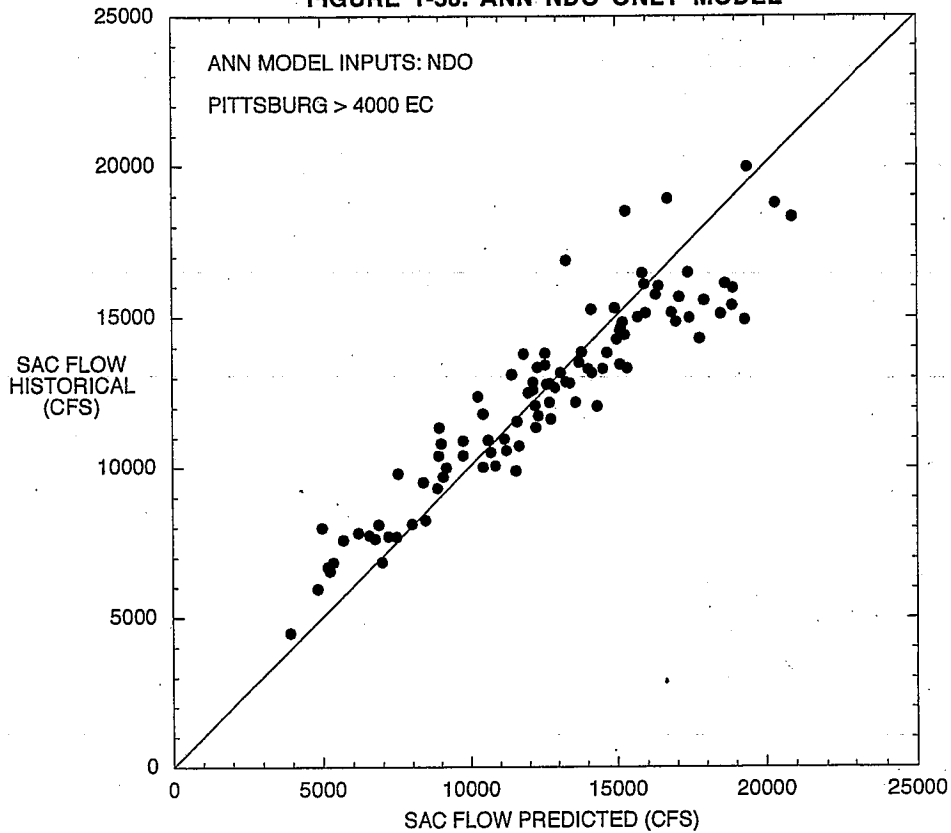

FIGURE 1-58. ANN NDO ONLY MODEL



SAC PREDICTIONS FROM CONTRA COSTA CANAL SIMULATED SALINITY HISTORICAL DATA

FIGURE 1-59. ANN MULTIPLE INPUT MODEL

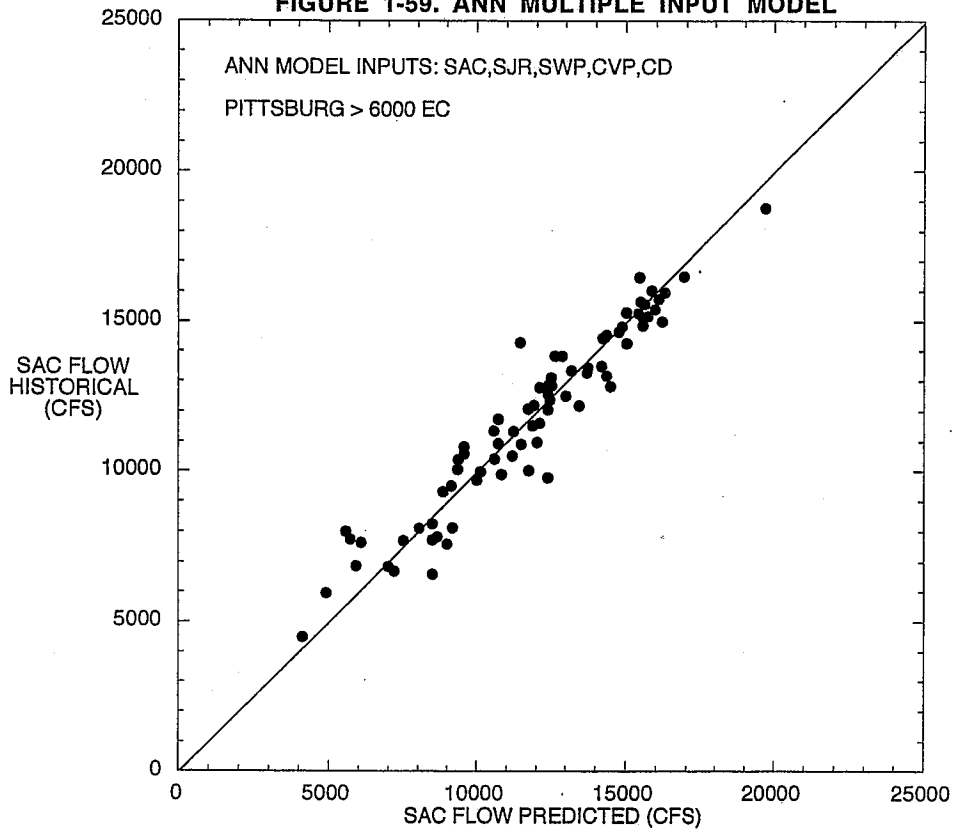
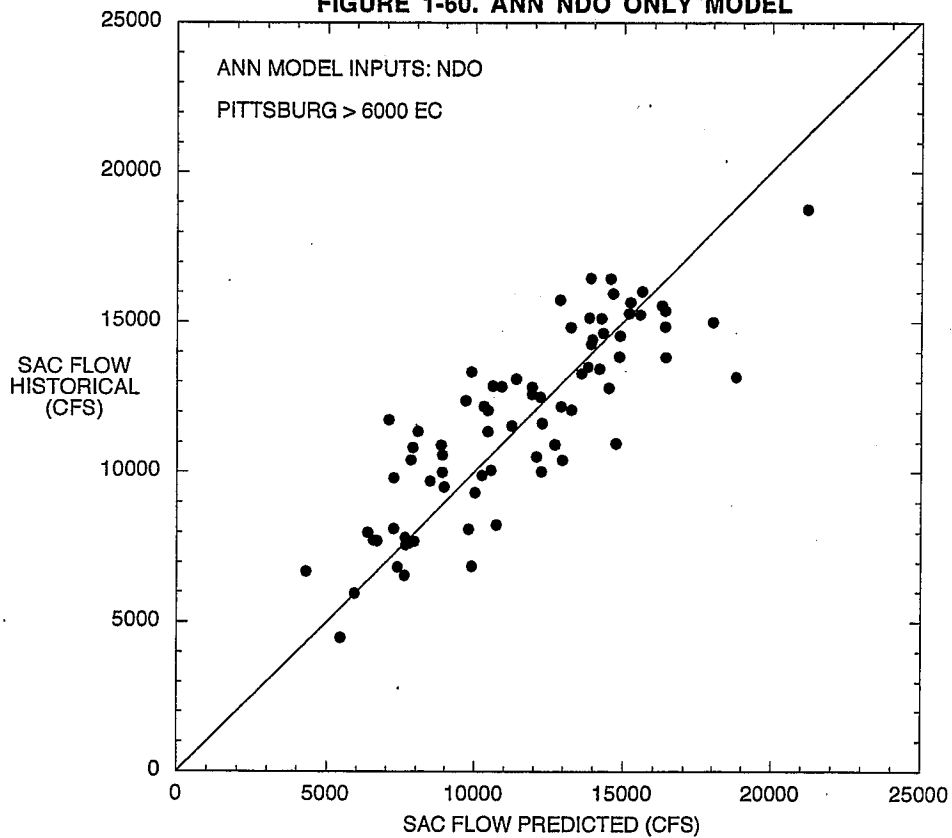

FIGURE 1-60. ANN NDO ONLY MODEL



CONTINUOUS IMPULSE MARGINAL EXPORT COST AT PITTSBURG

HISTORICAL DATA - ANN MULTIPLE INPUT MODEL

FIG 1-61. MARGINAL EXPORT COST FOR 1000 CFS INCREASE IN EXPORTS

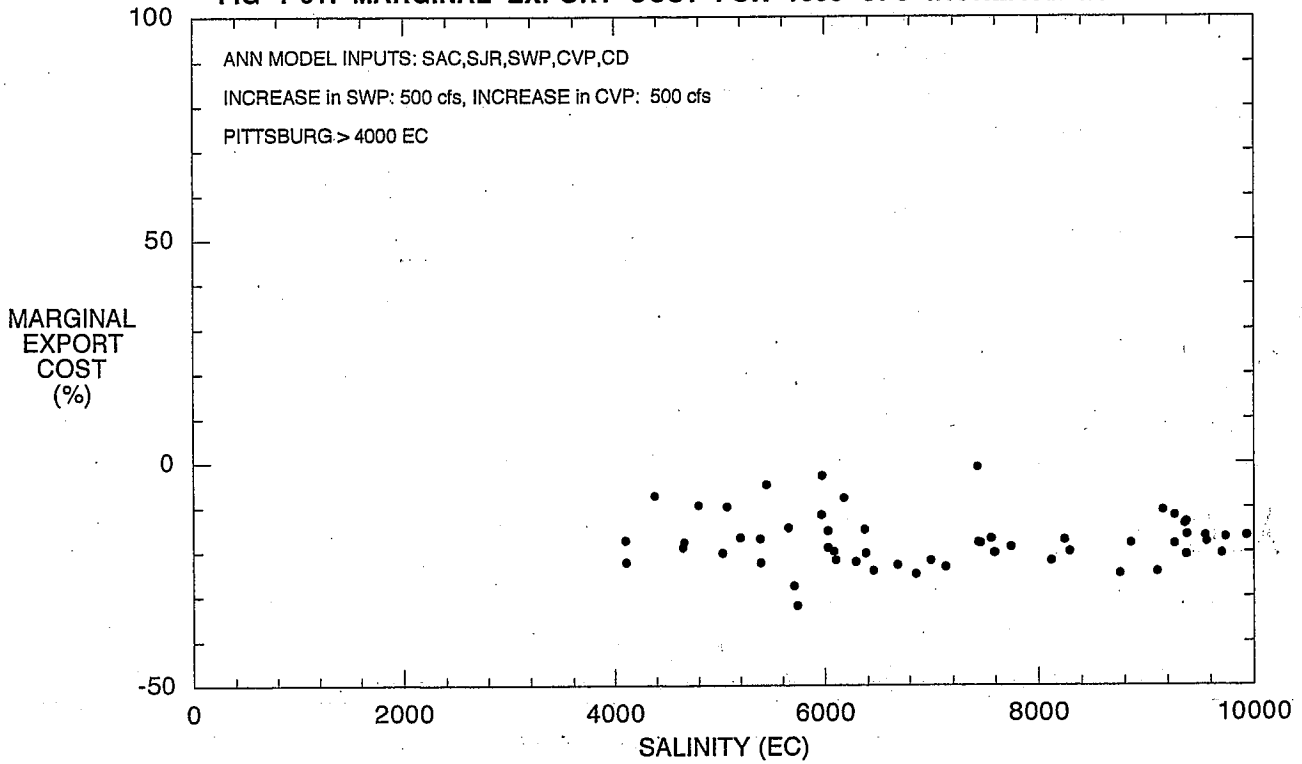
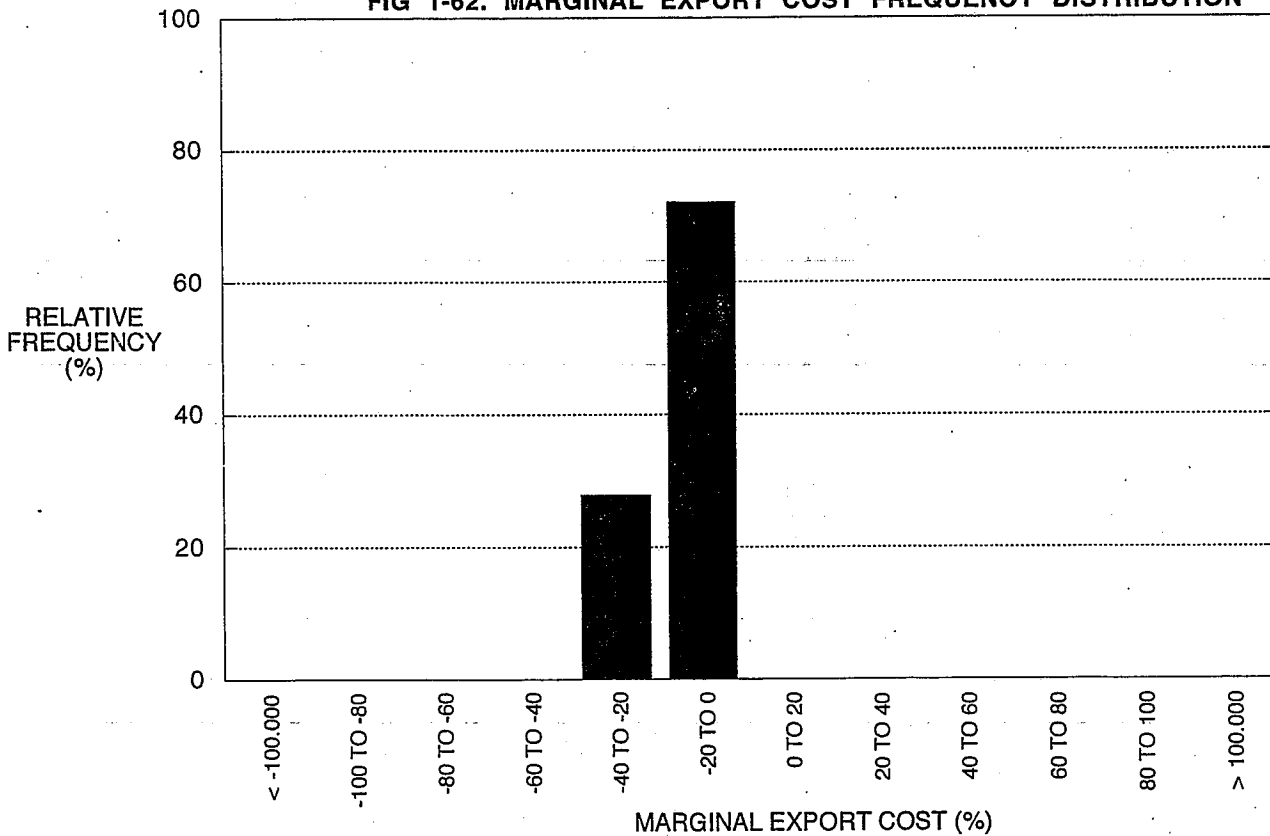

FIG 1-62. MARGINAL EXPORT COST FREQUENCY DISTRIBUTION



CONTINUOUS IMPULSE MARGINAL EXPORT COST AT EMMATON

HISTORICAL DATA - ANN MULTIPLE INPUT MODEL

FIG 1-63. MARGINAL EXPORT COST FOR 1000 CFS INCREASE IN EXPORTS

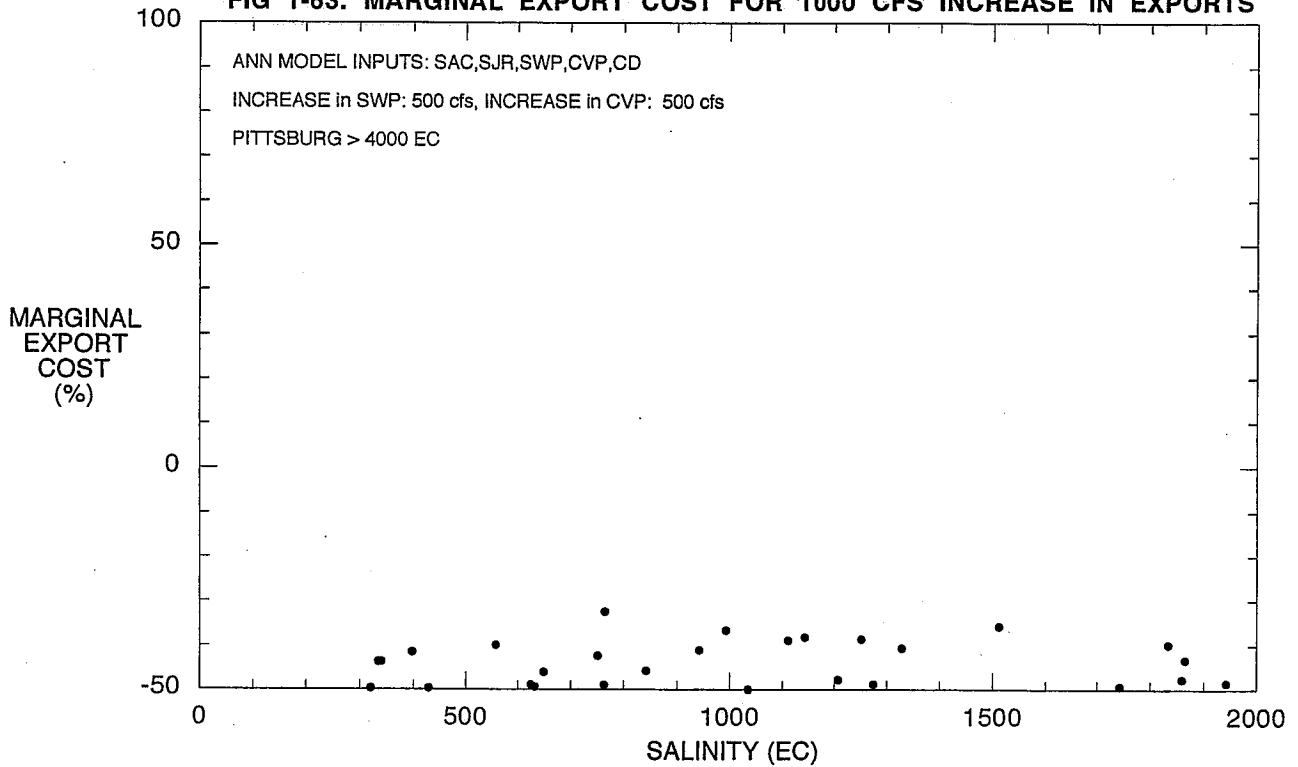
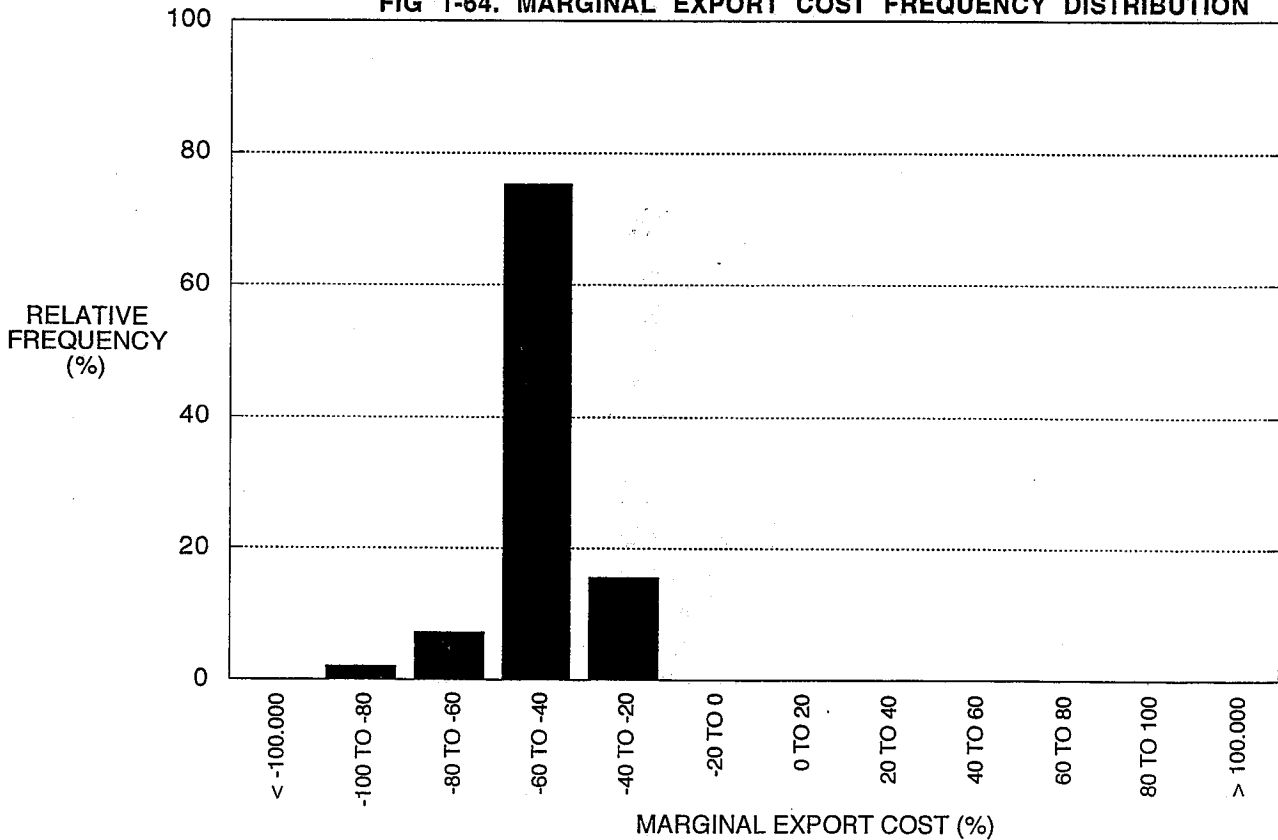

FIG 1-64. MARGINAL EXPORT COST FREQUENCY DISTRIBUTION



CONTINUOUS IMPULSE MARGINAL EXPORT COST AT JERSEY POINT

HISTORICAL DATA - ANN MULTIPLE INPUT MODEL

FIG 1-65. MARGINAL EXPORT COST FOR 1000 CFS INCREASE IN EXPORTS

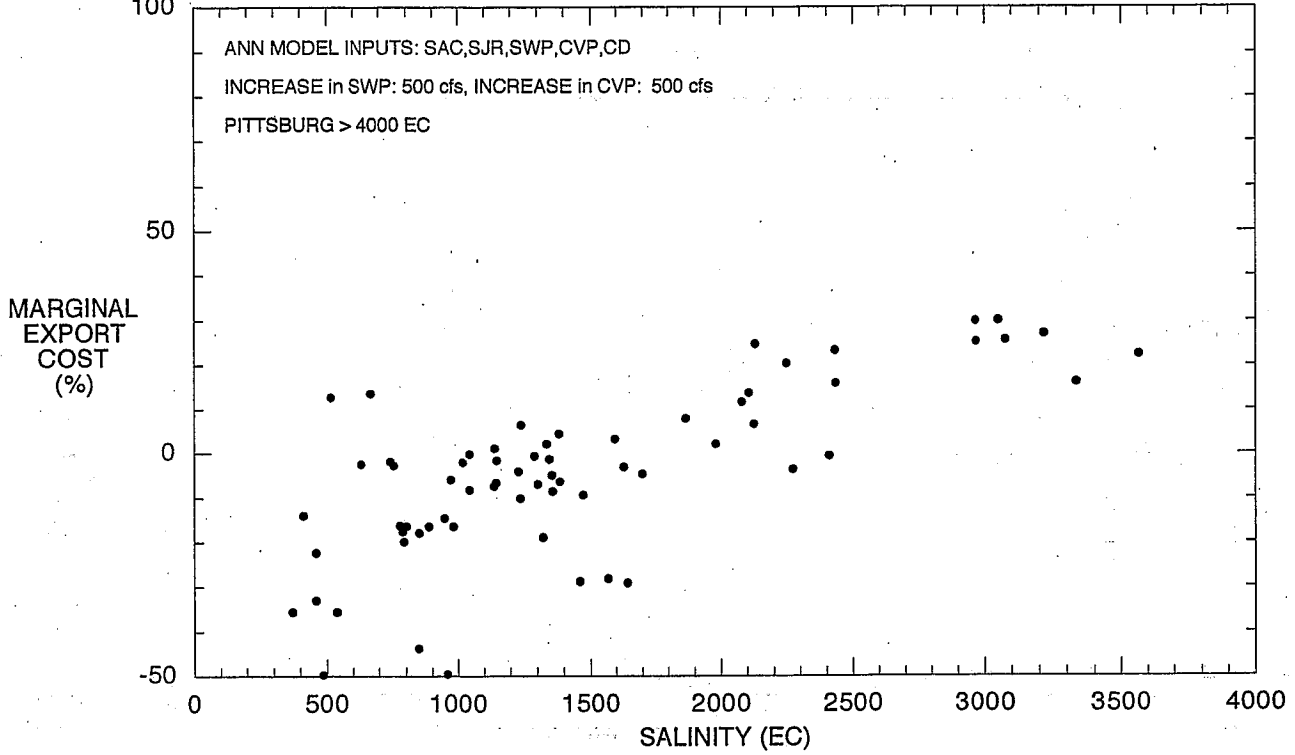
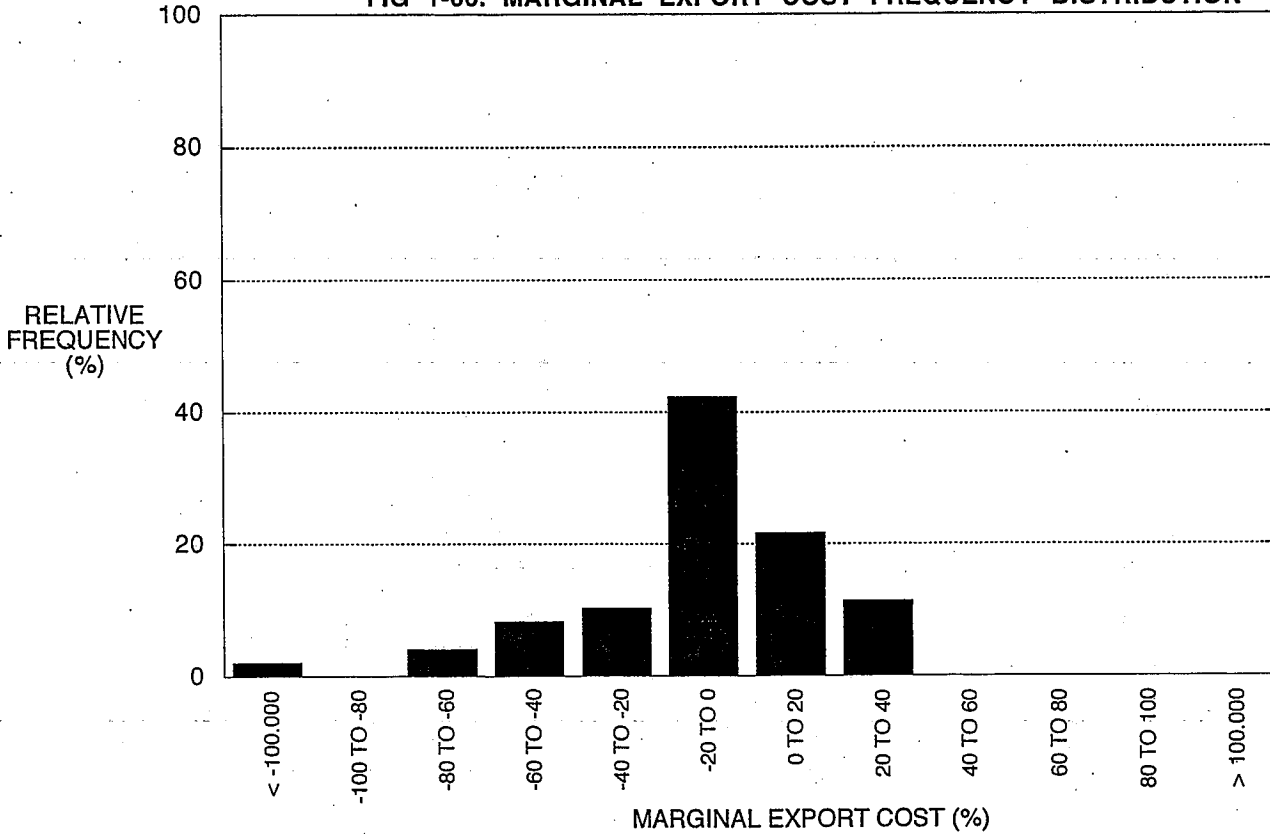

FIG 1-66. MARGINAL EXPORT COST FREQUENCY DISTRIBUTION



CONTINUOUS IMPULSE MARGINAL EXPORT COST AT CONTRA COSTA CANAL

HISTORICAL DATA - ANN MULTIPLE INPUT MODEL

FIG 1-67. MARGINAL EXPORT COST FOR 1000 CFS INCREASE IN EXPORTS

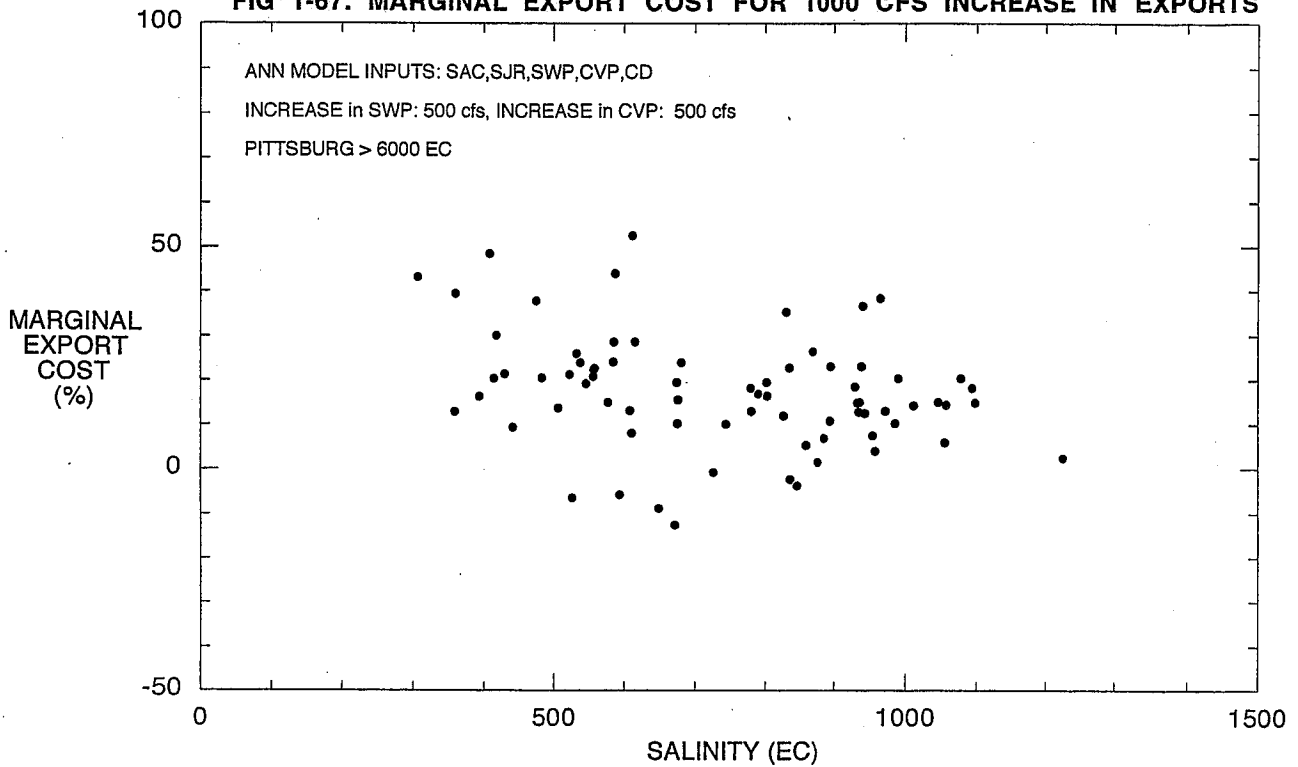
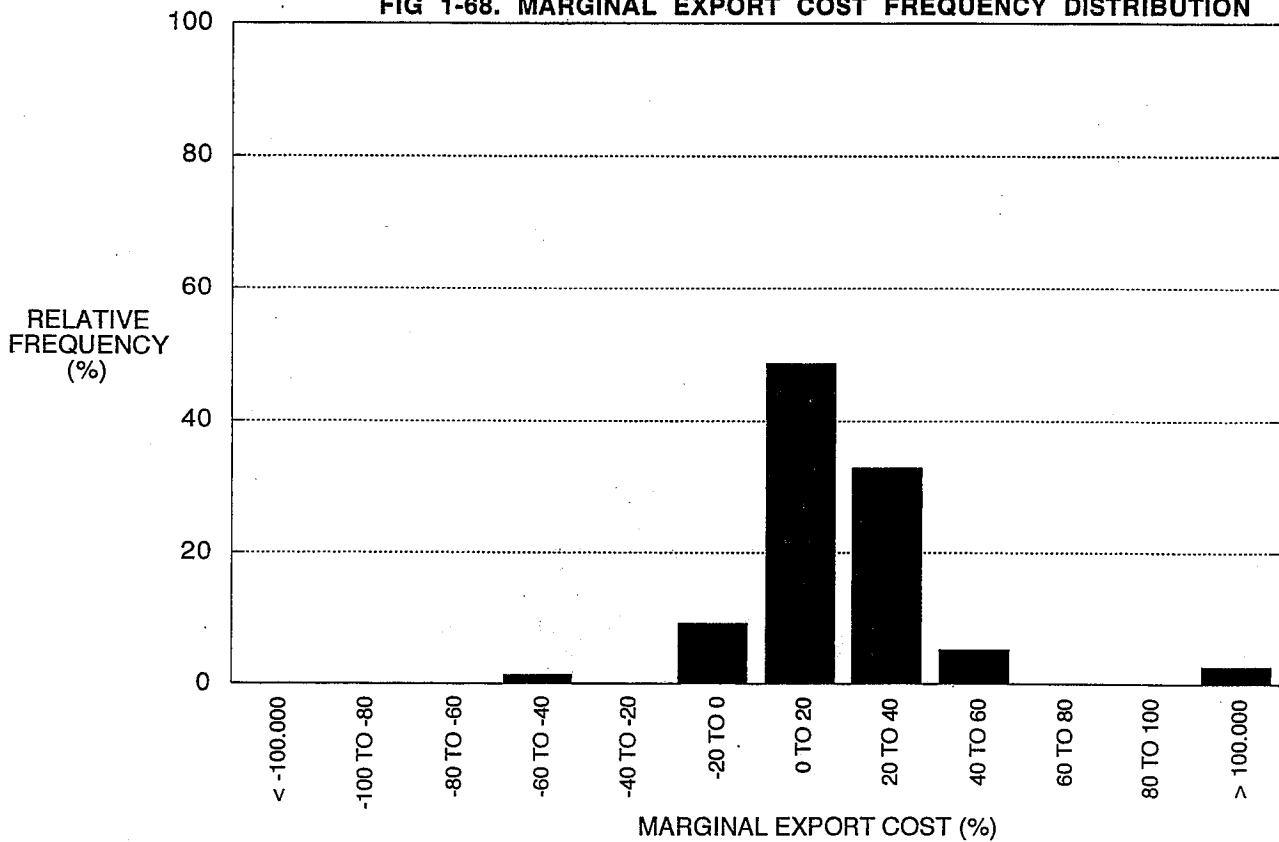

FIG 1-68. MARGINAL EXPORT COST FREQUENCY DISTRIBUTION



CONTINUOUS IMPULSE MARGINAL EXPORT COST AT CLIFTON COURT FOREBAY HISTORICAL DATA - ANN MULTIPLE INPUT MODEL

FIG 1-69. MARGINAL EXPORT COST FOR 1000 CFS INCREASE IN EXPORTS

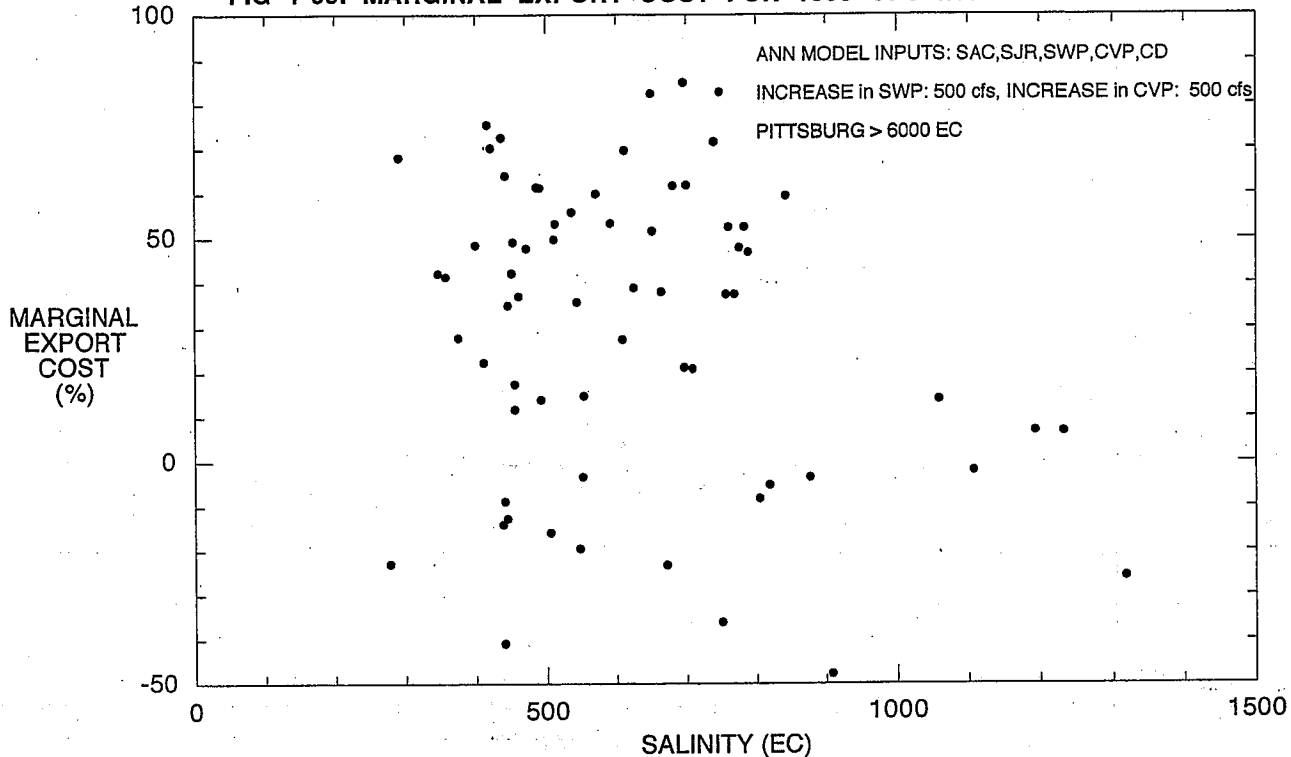
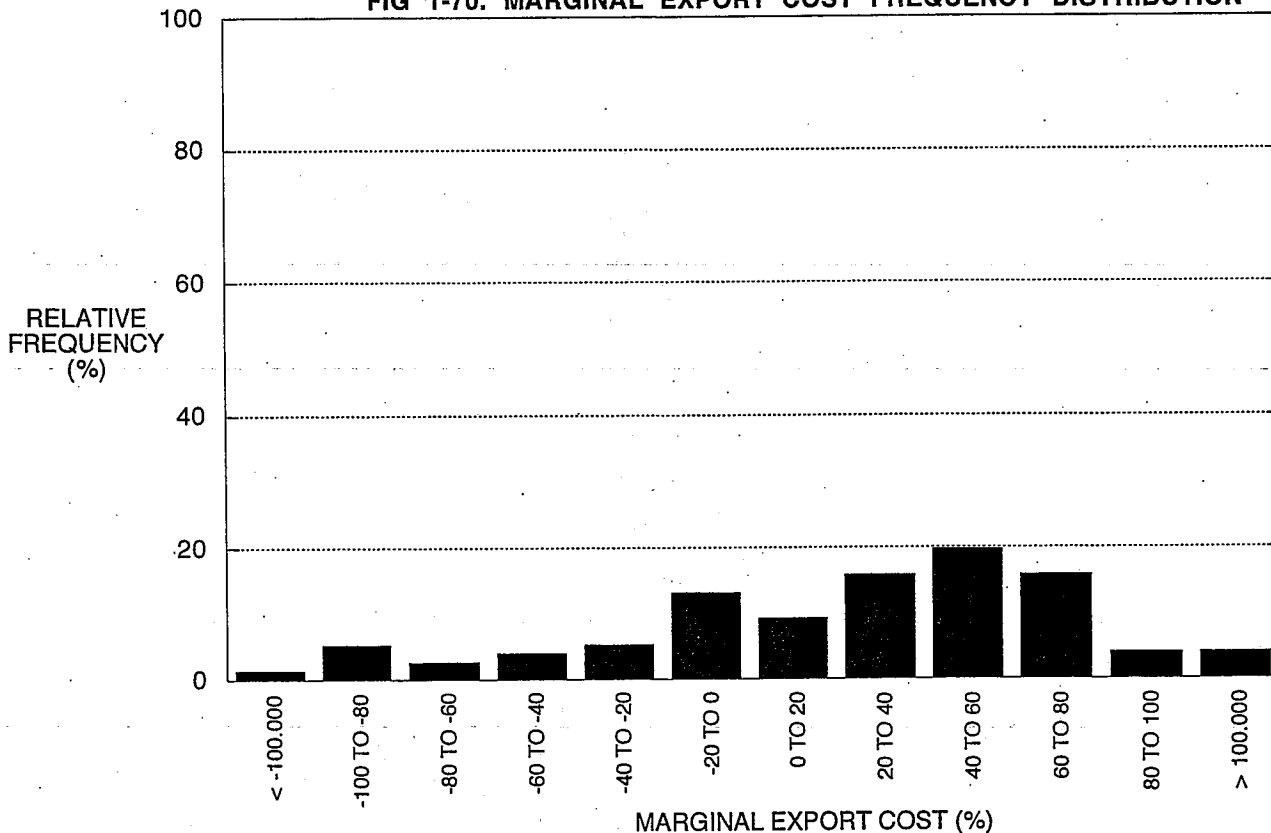

FIG 1-70. MARGINAL EXPORT COST FREQUENCY DISTRIBUTION



CONTINUOUS IMPULSE MARGINAL EXPORT COST AT PITTSBURG

DSM DATA - ANN MULTIPLE INPUT MODEL

FIG. 1-71. MARGINAL EXPORT COST FOR 1000 CFS INCREASE IN EXPORTS

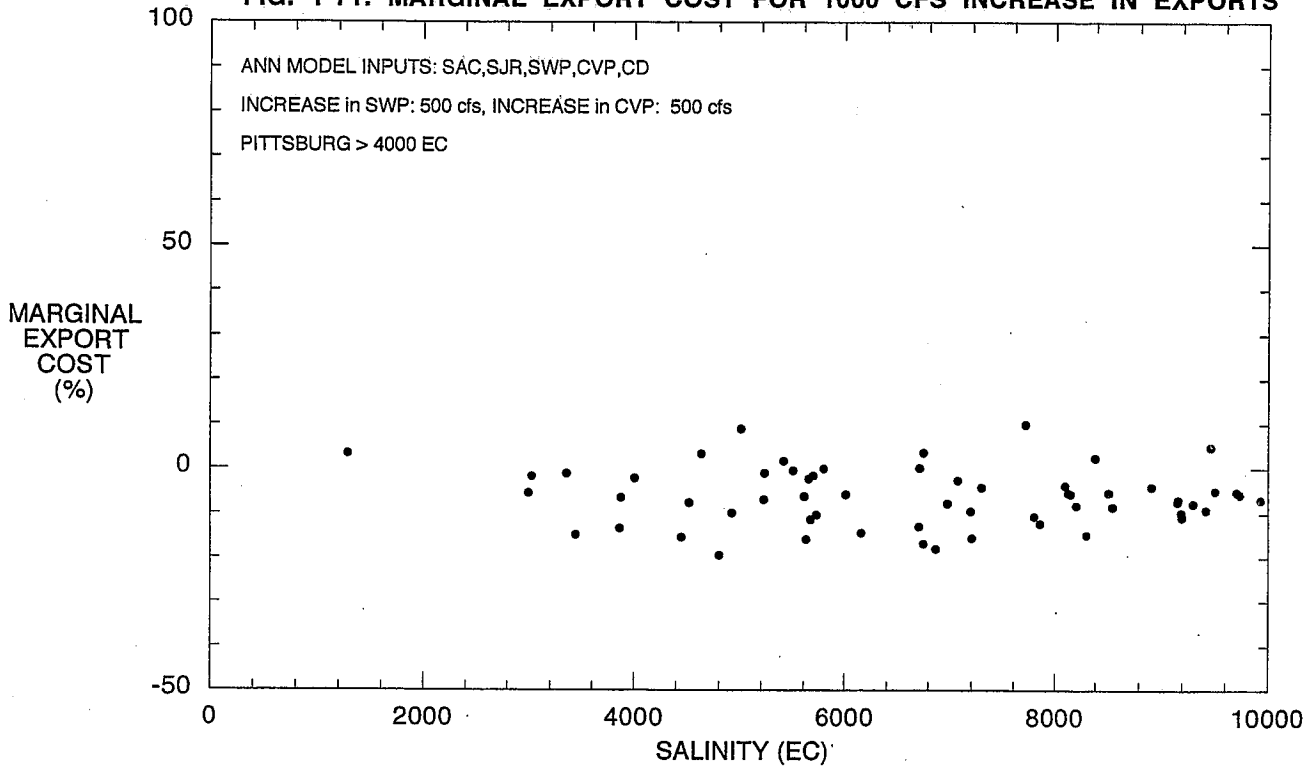
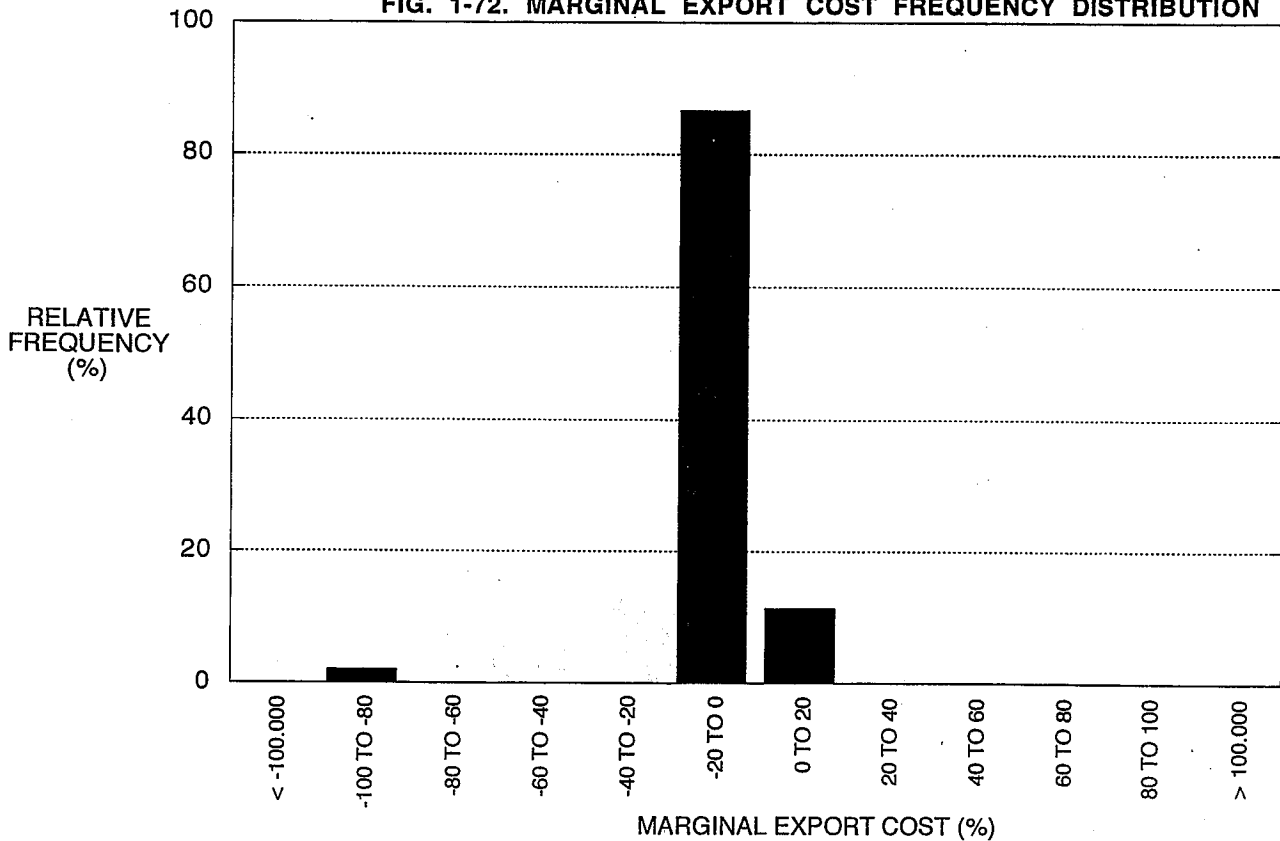

FIG. 1-72. MARGINAL EXPORT COST FREQUENCY DISTRIBUTION



CONTINUOUS IMPULSE MARGINAL EXPORT COST AT EMMATON

DSM DATA - ANN MULTIPLE INPUT MODEL

FIG. 1-73. MARGINAL EXPORT COST FOR 1000 CFS INCREASE IN EXPORTS

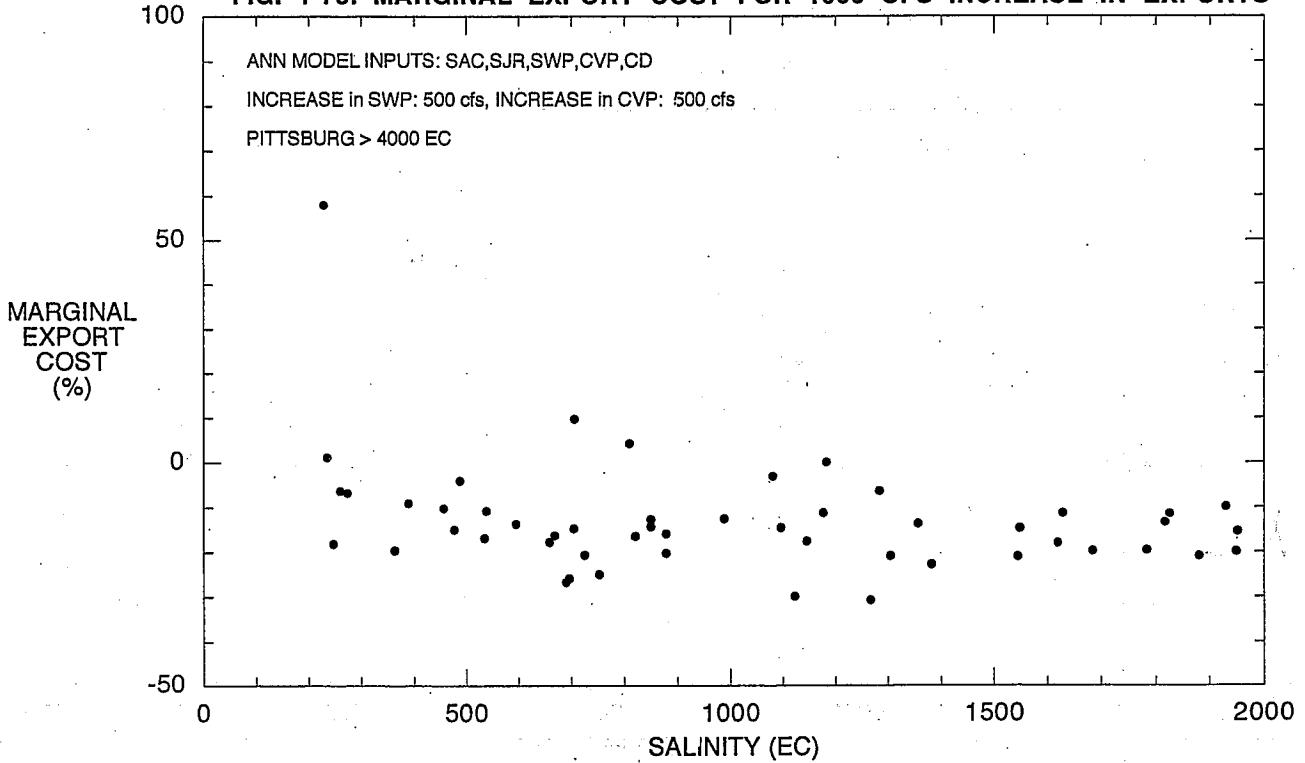
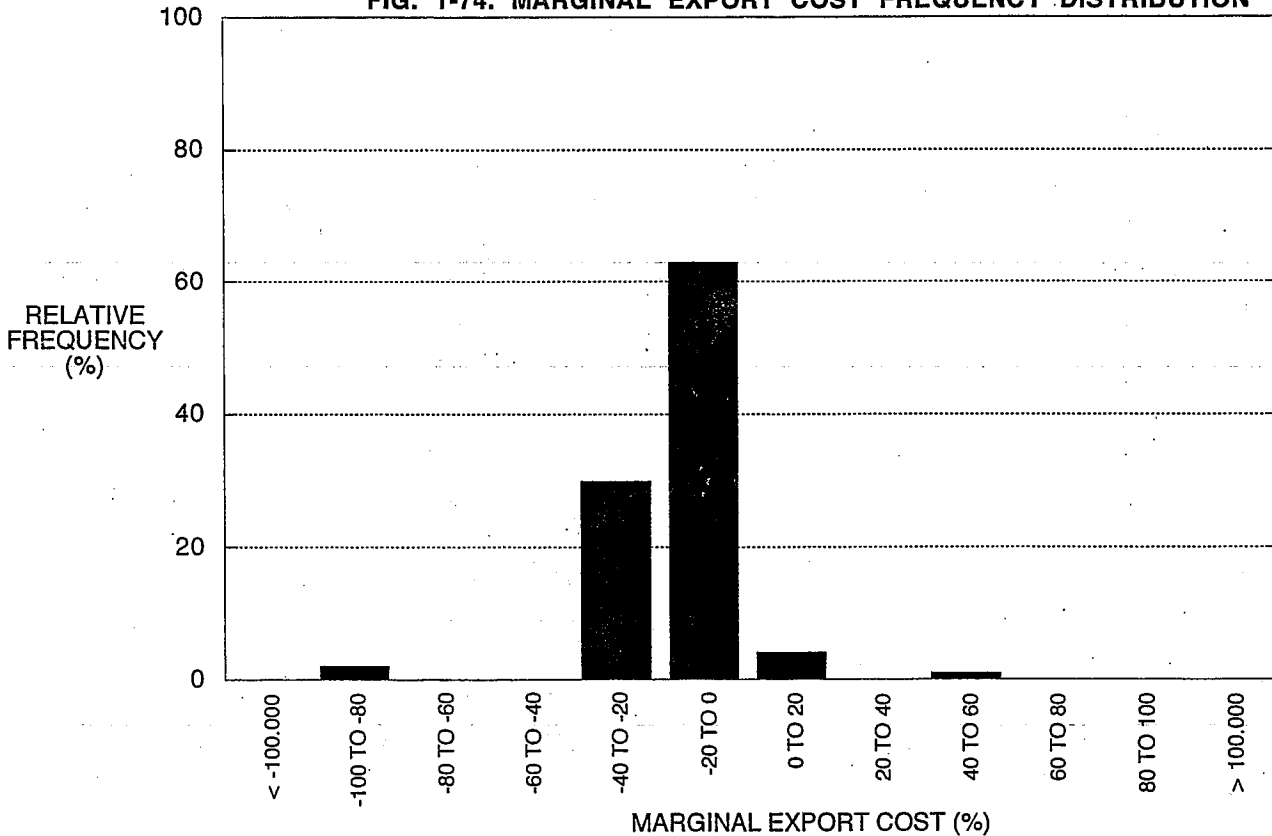
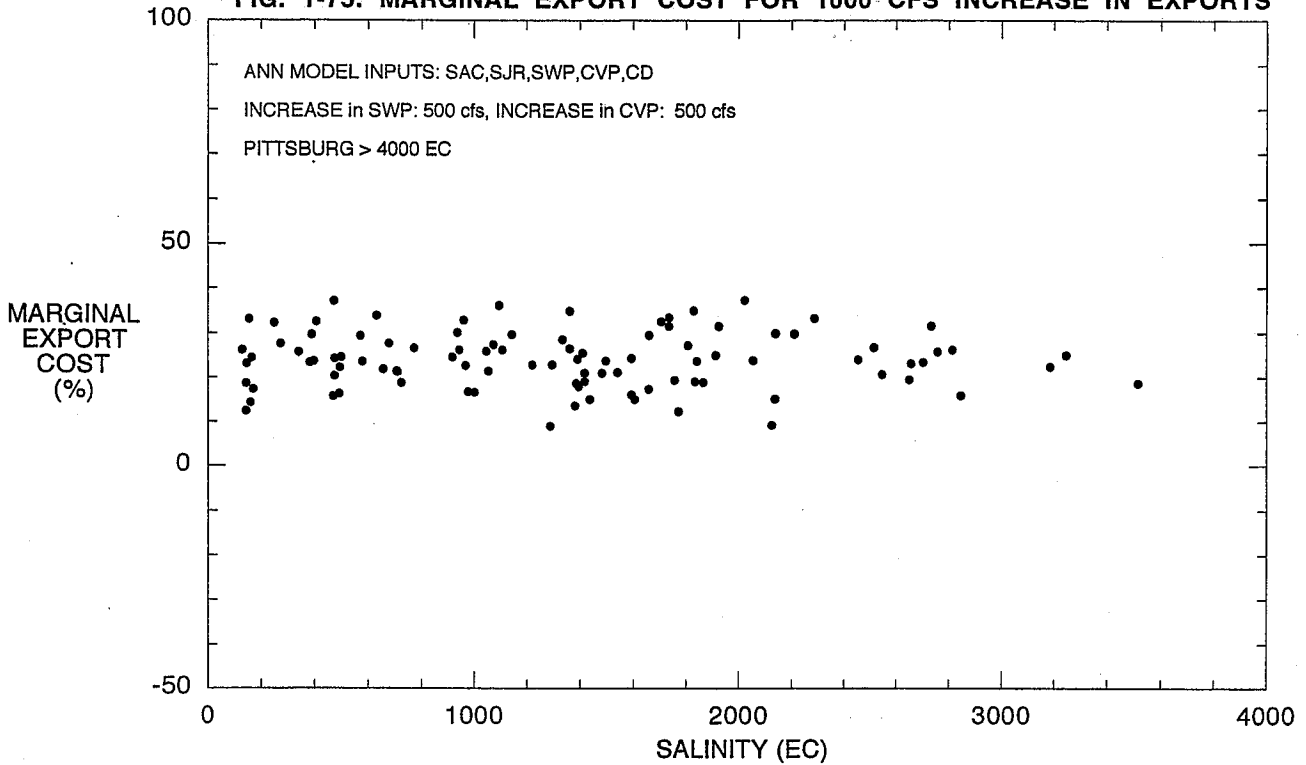

FIG. 1-74. MARGINAL EXPORT COST FREQUENCY DISTRIBUTION



CONTINUOUS IMPULSE MARGINAL EXPORT COST AT JERSEY POINT DSM DATA - ANN MULTIPLE INPUT MODEL

FIG. 1-75. MARGINAL EXPORT COST FOR 1000 CFS INCREASE IN EXPORTS



CONTINUOUS IMPULSE MARGINAL EXPORT COST AT CONTRA COSTA CANAL DSM DATA - ANN MULTIPLE INPUT MODEL

FIG 1-77. MARGINAL EXPORT COST FOR 1000 CFS INCREASE IN EXPORTS

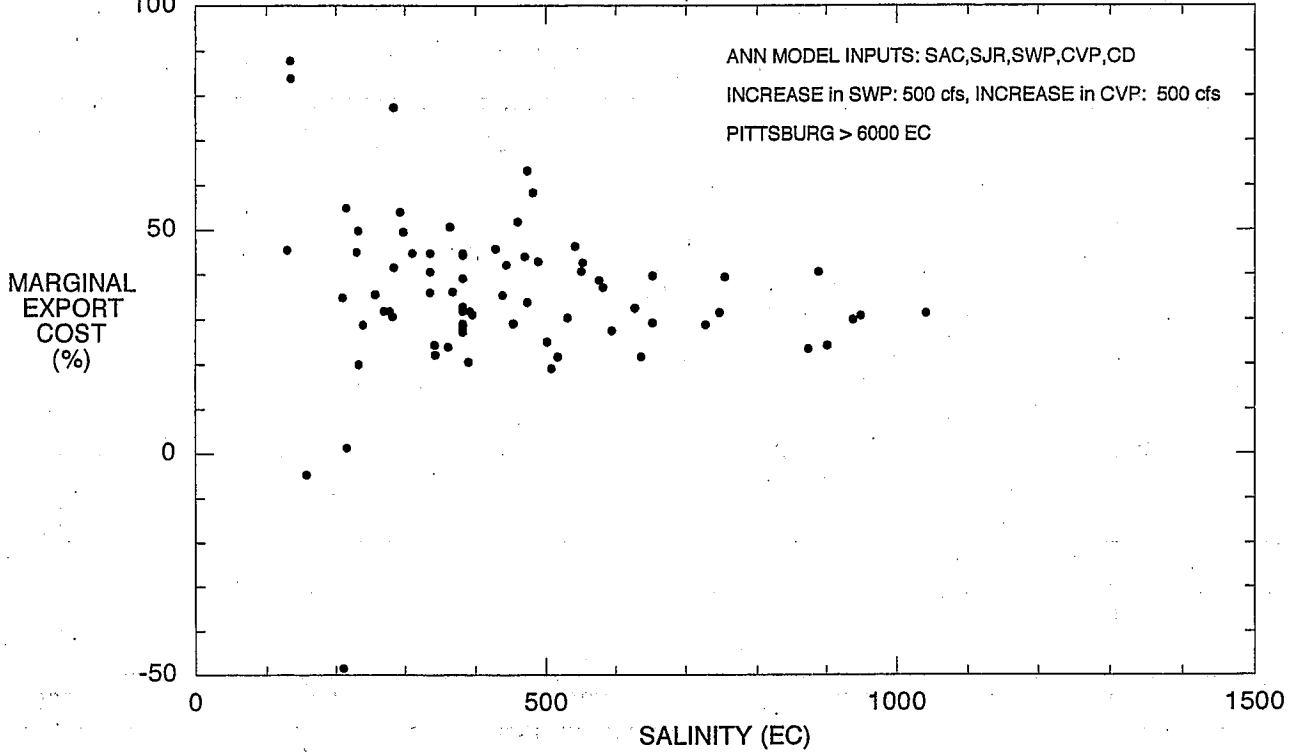
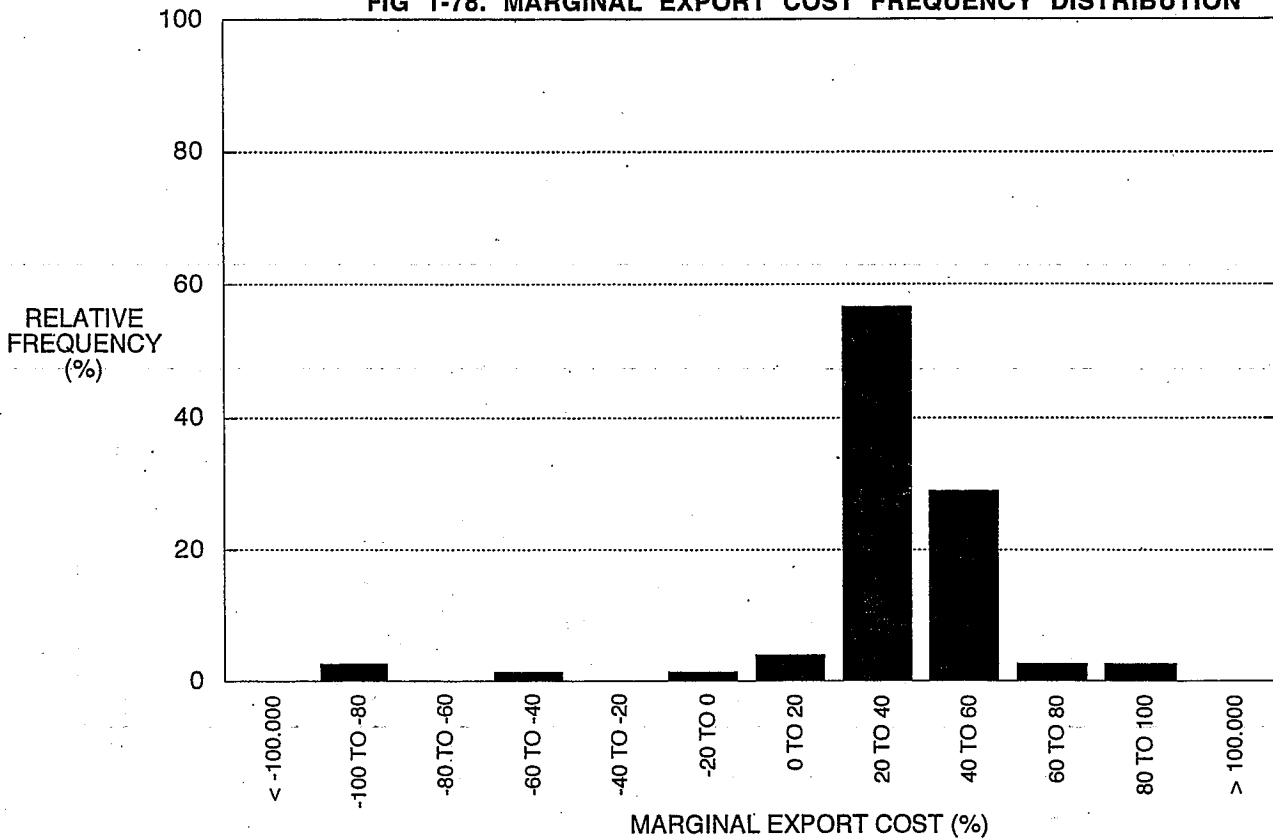

FIG 1-78. MARGINAL EXPORT COST FREQUENCY DISTRIBUTION



CONTINUOUS IMPULSE MARGINAL EXPORT COST AT CLIFTON COURT FOREBAY DSM DATA - ANN MULTIPLE INPUT MODEL

FIG. 1-79. MARGINAL EXPORT COST FOR 1000 CFS INCREASE IN EXPORTS

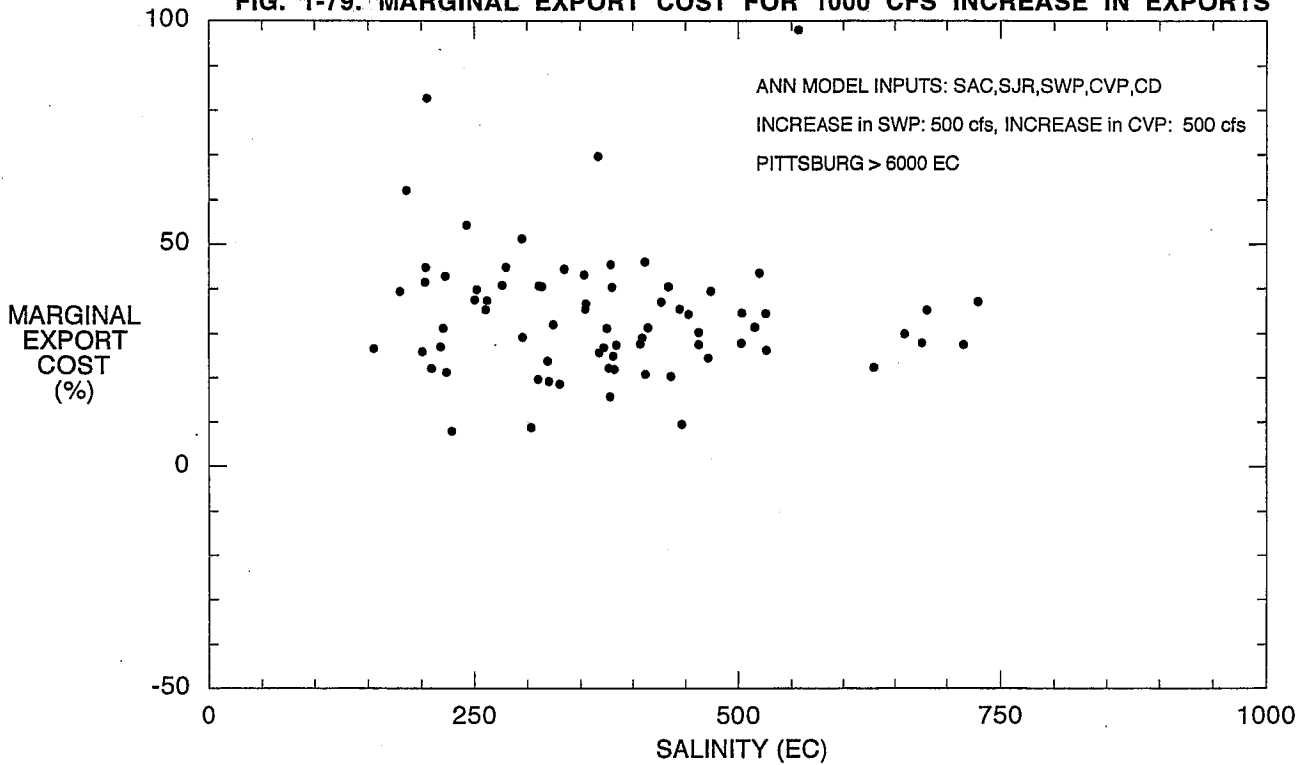
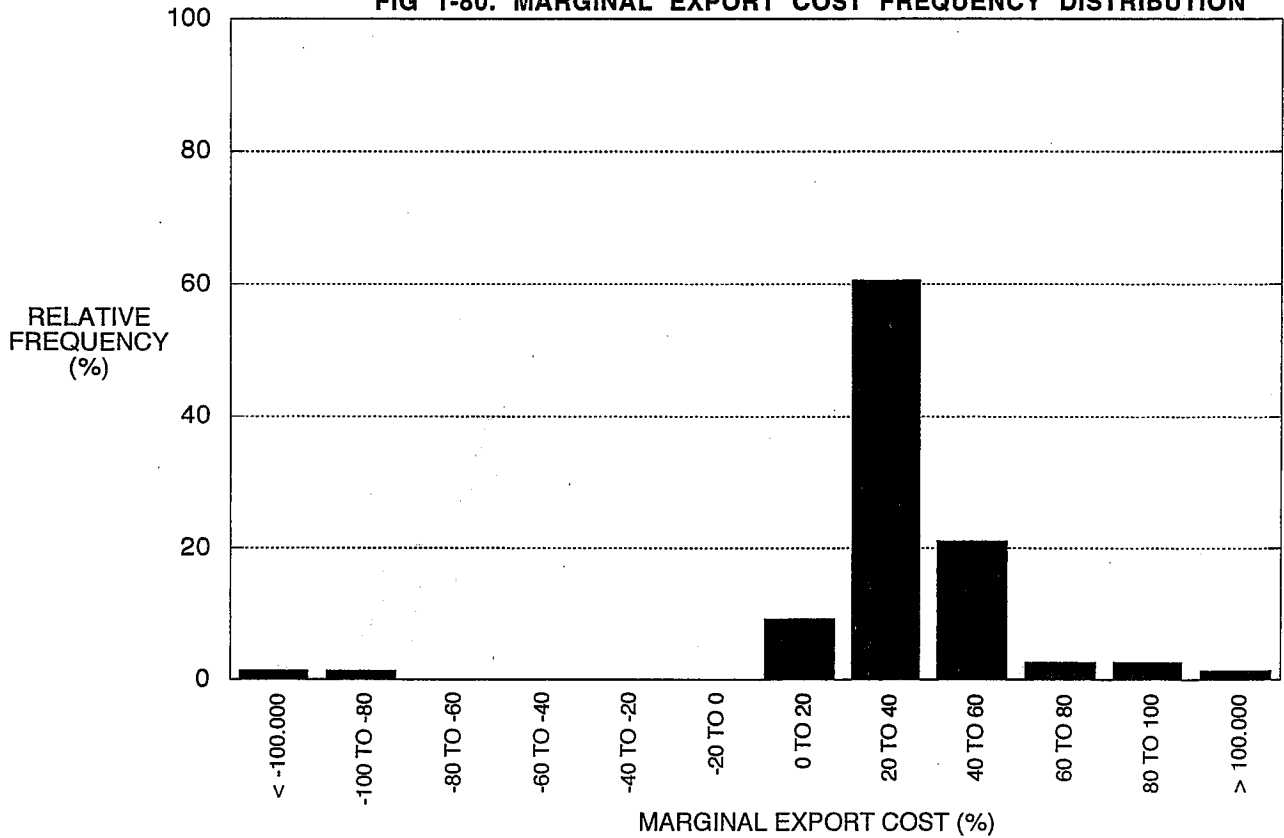

FIG 1-80. MARGINAL EXPORT COST FREQUENCY DISTRIBUTION



TRANSIENT IMPULSE MARGINAL EXPORT COST AT PITTSBURG

HISTORICAL DATA - ANN MULTIPLE INPUT MODEL

FIG 1-81. MARGINAL EXPORT COST FOR 1000 CFS INCREASE IN EXPORTS

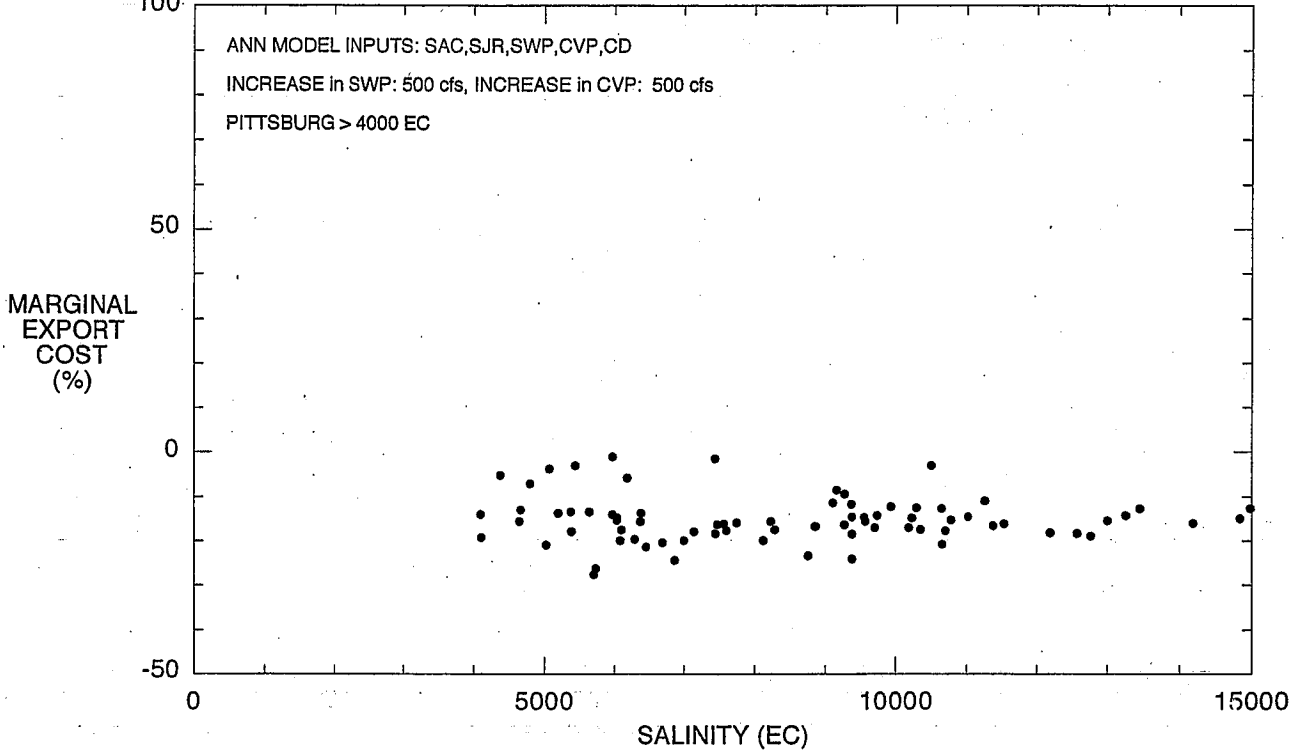
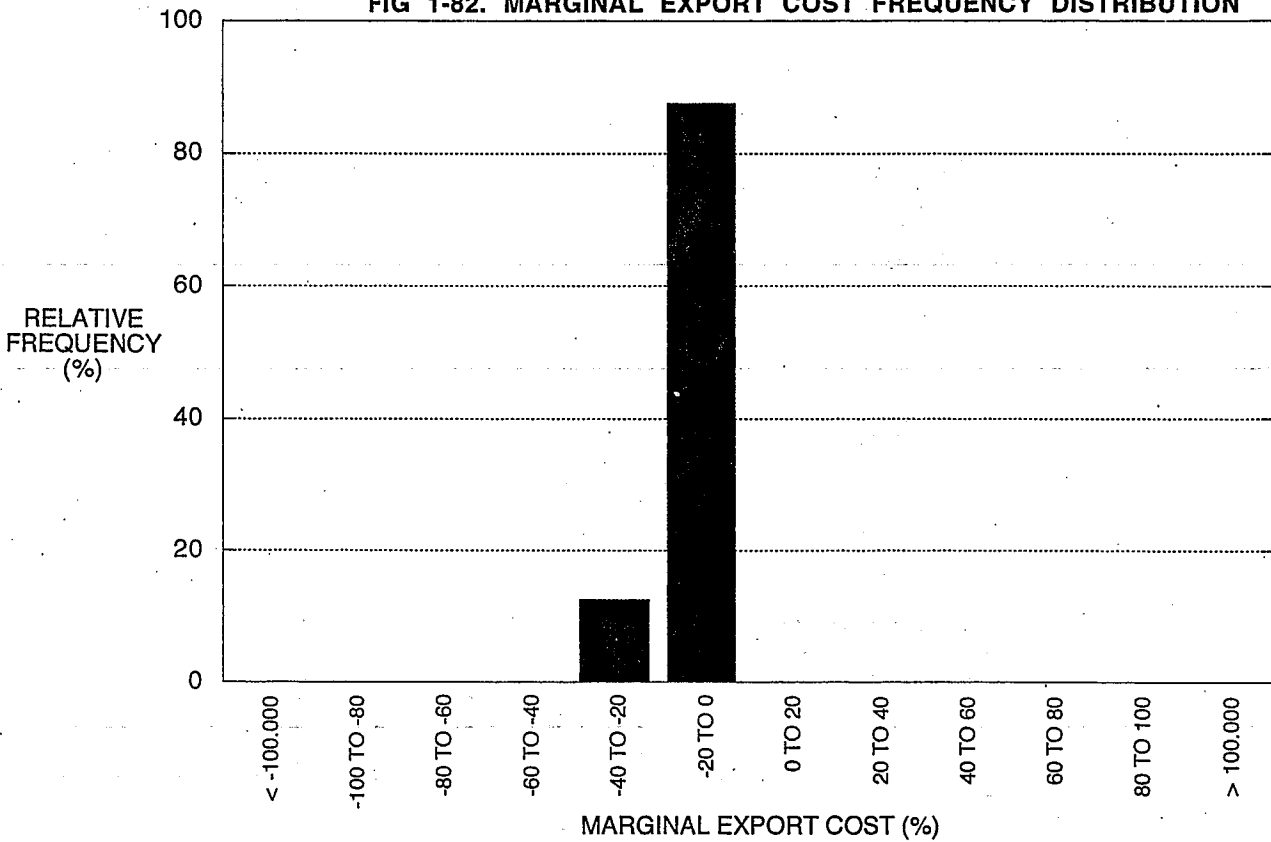

FIG 1-82. MARGINAL EXPORT COST FREQUENCY DISTRIBUTION



TRANSIENT IMPULSE MARGINAL EXPORT COST AT EMMATON

HISTORICAL DATA - ANN MULTIPLE INPUT MODEL

FIG 1-83. MARGINAL EXPORT COST FOR 1000 CFS INCREASE IN EXPORTS

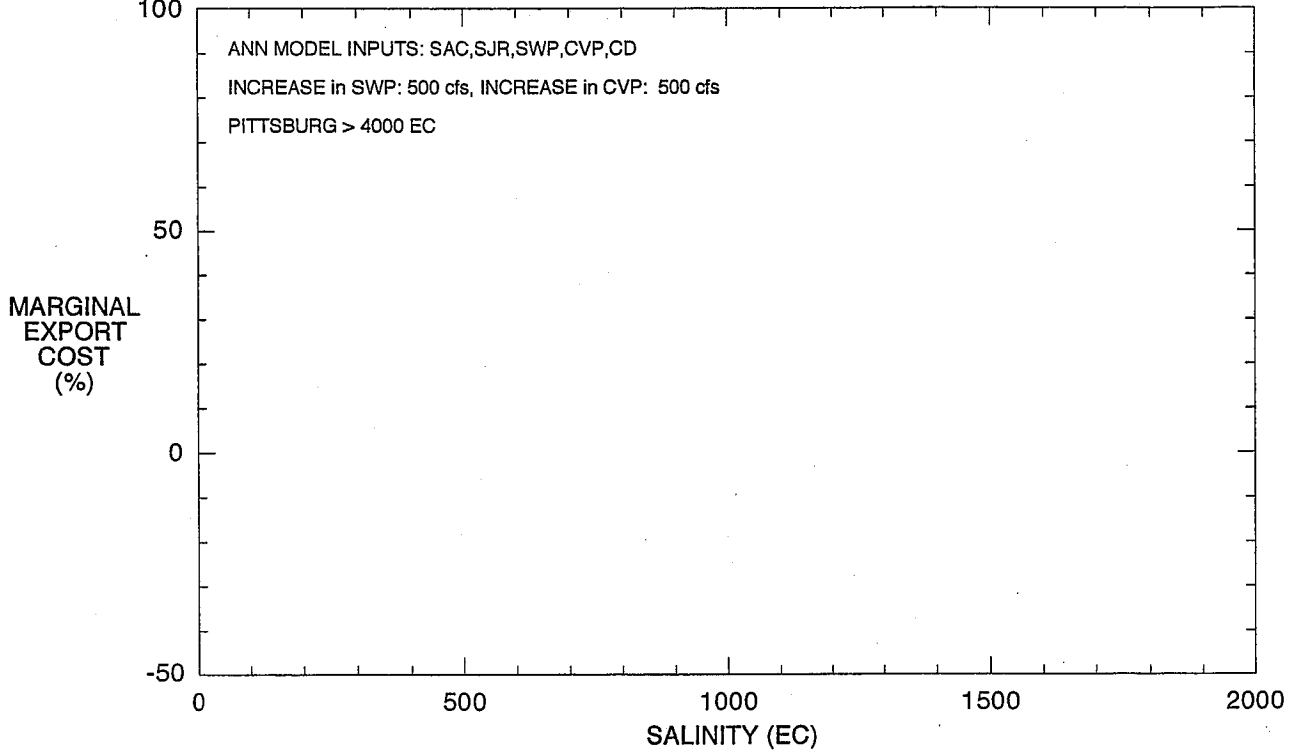
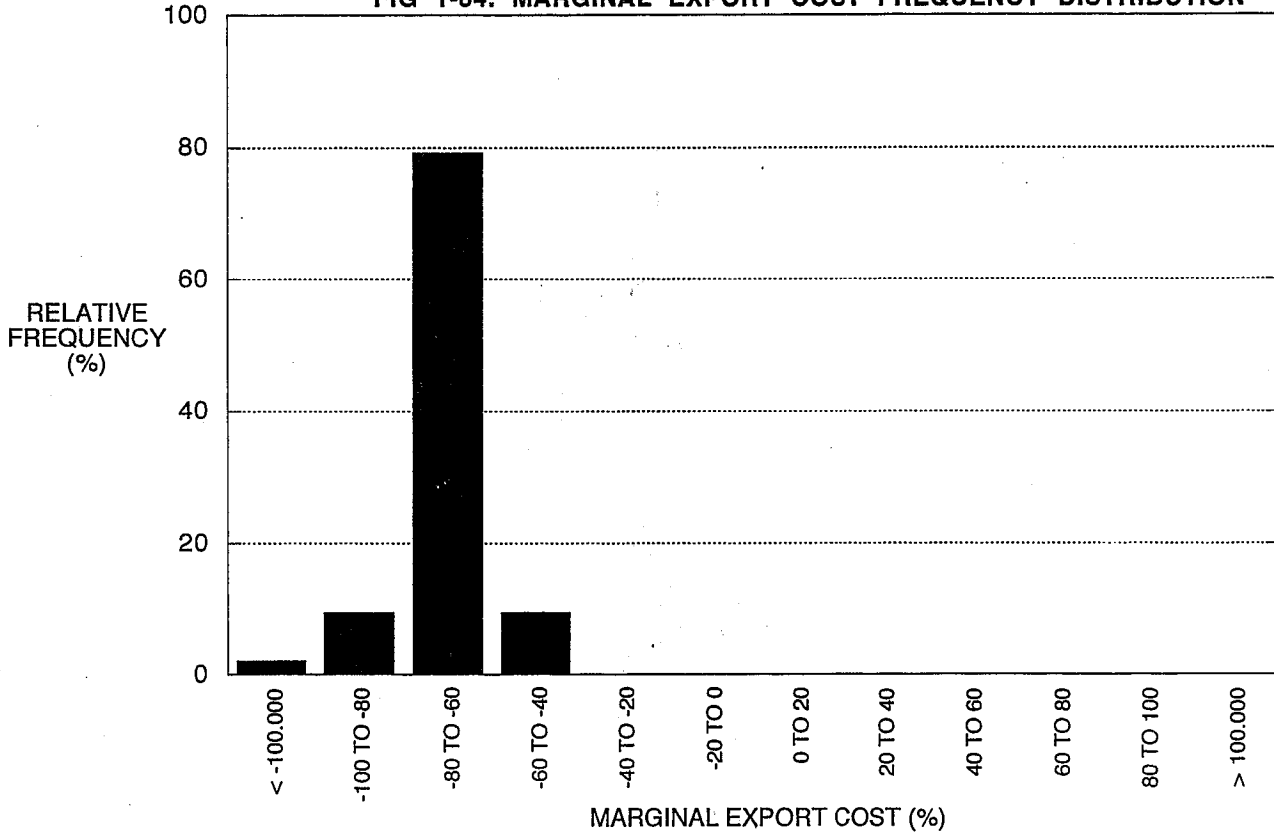

FIG 1-84. MARGINAL EXPORT COST FREQUENCY DISTRIBUTION



TRANSIENT IMPULSE MARGINAL EXPORT COST AT JERSEY POINT

HISTORICAL DATA - ANN MULTIPLE INPUT MODEL

FIG 1-85. MARGINAL EXPORT COST FOR 1000 CFS INCREASE IN EXPORTS

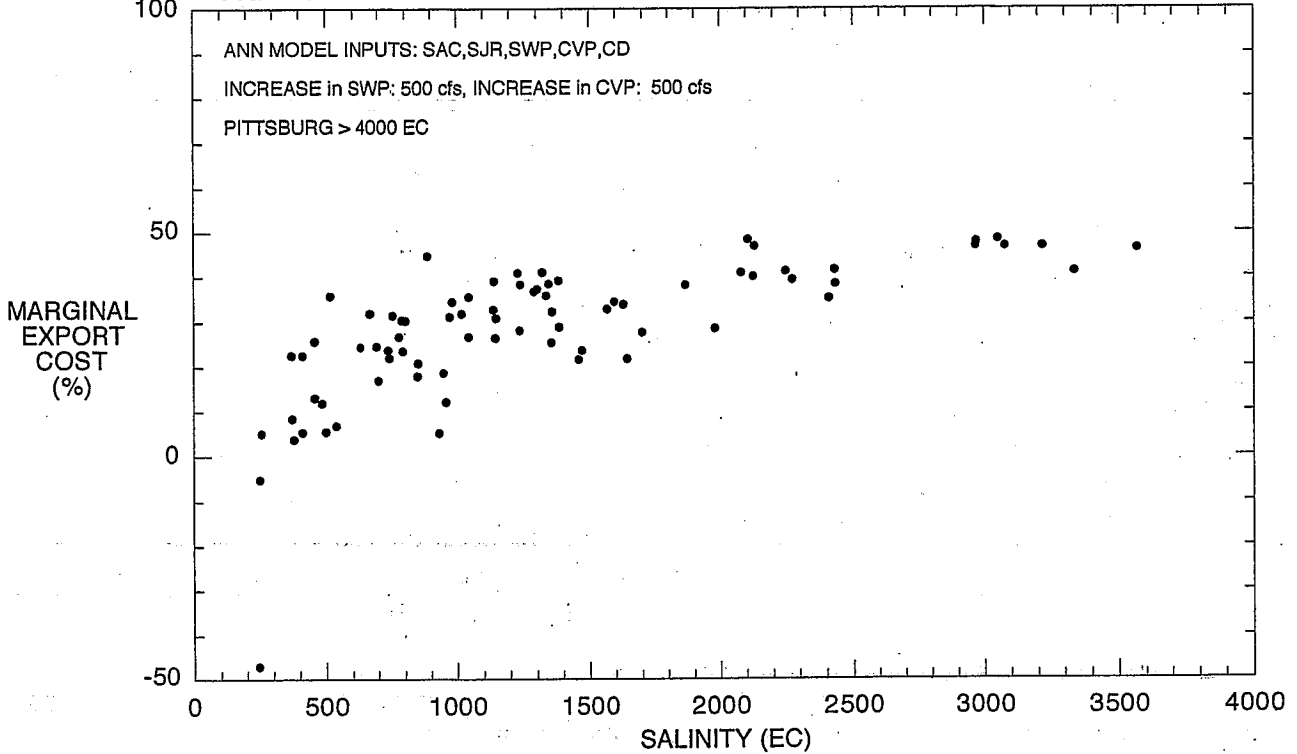
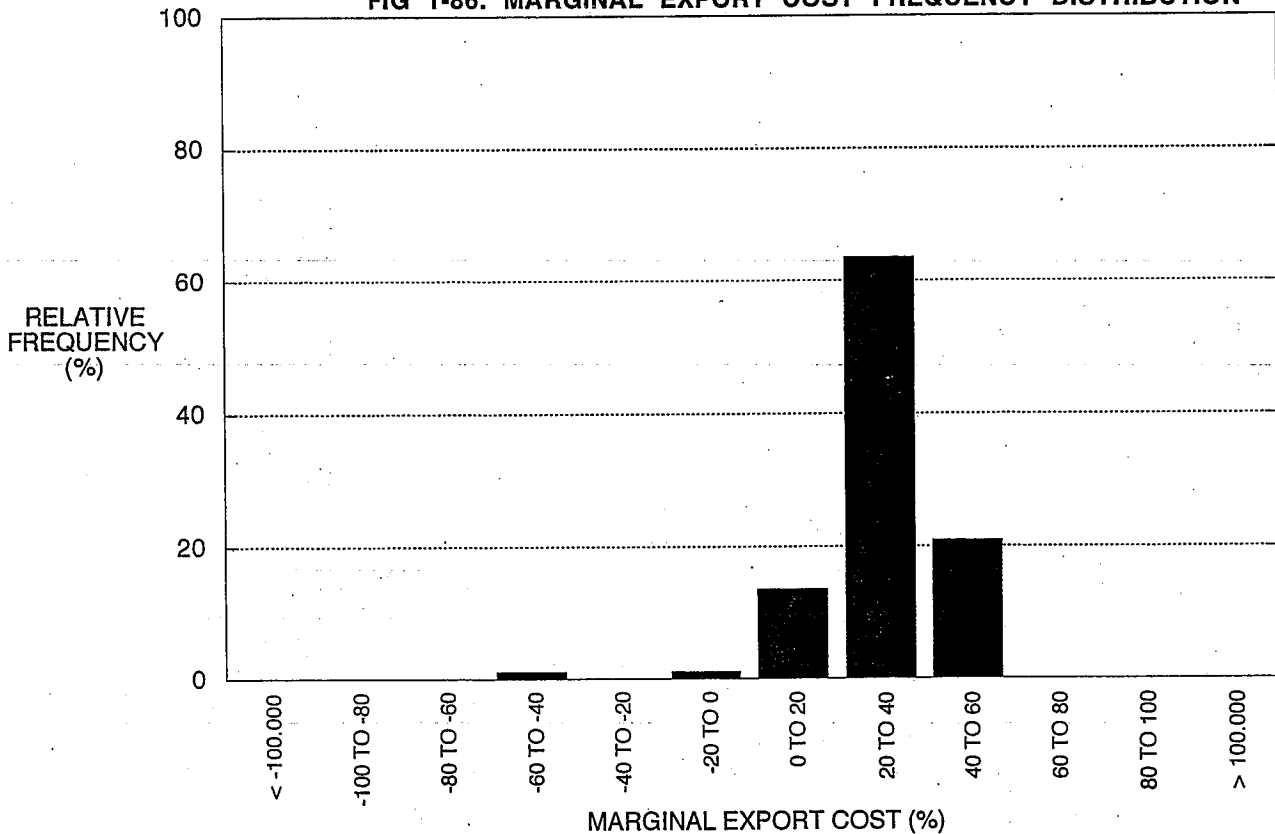
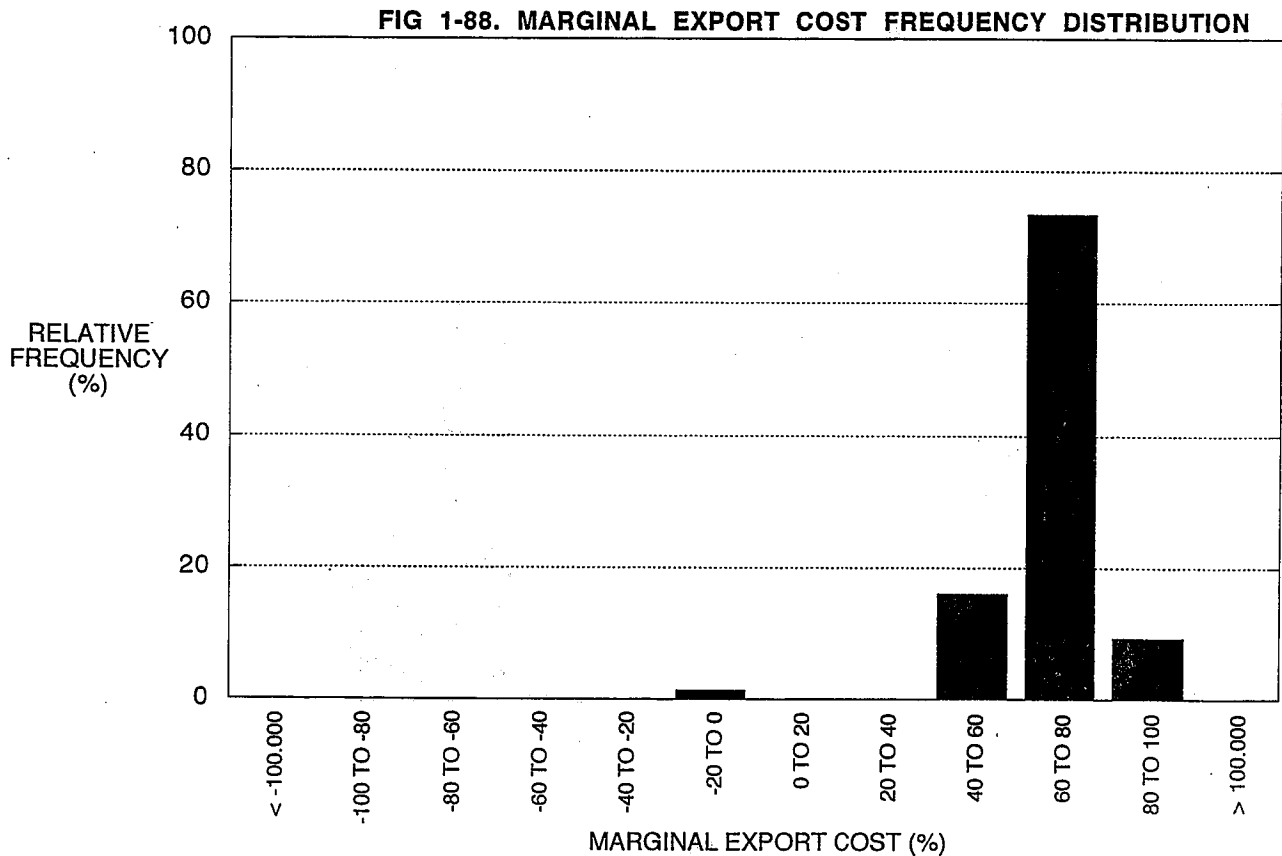
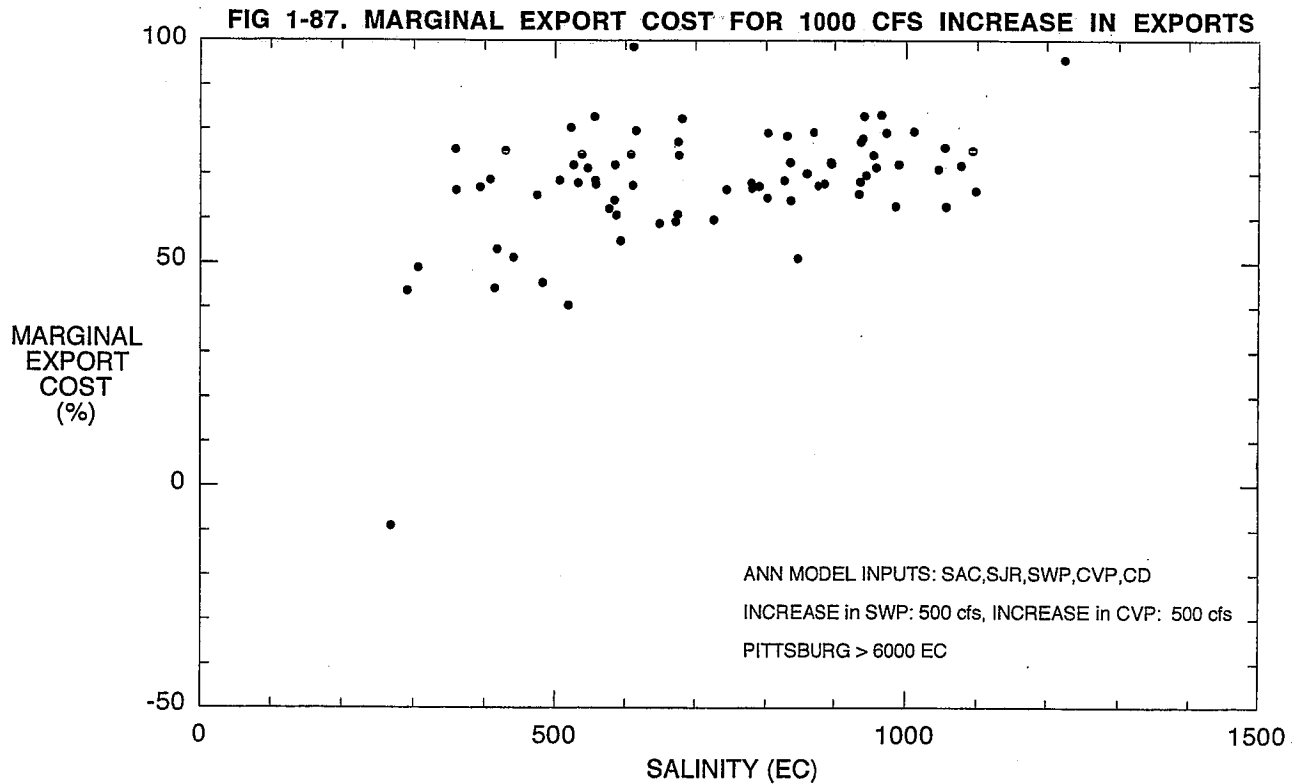

FIG 1-86. MARGINAL EXPORT COST FREQUENCY DISTRIBUTION



**TRANSIENT IMPULSE MARGINAL EXPORT COST
AT CONTRA COSTA CANAL
HISTORICAL DATA - ANN MULTIPLE INPUT MODEL**



TRANSIENT IMPULSE MARGINAL EXPORT COST AT CLIFTON COURT FOREBAY HISTORICAL DATA - ANN MULTIPLE INPUT MODEL

FIG 1-89. MARGINAL EXPORT COST FOR 1000 CFS INCREASE IN EXPORTS

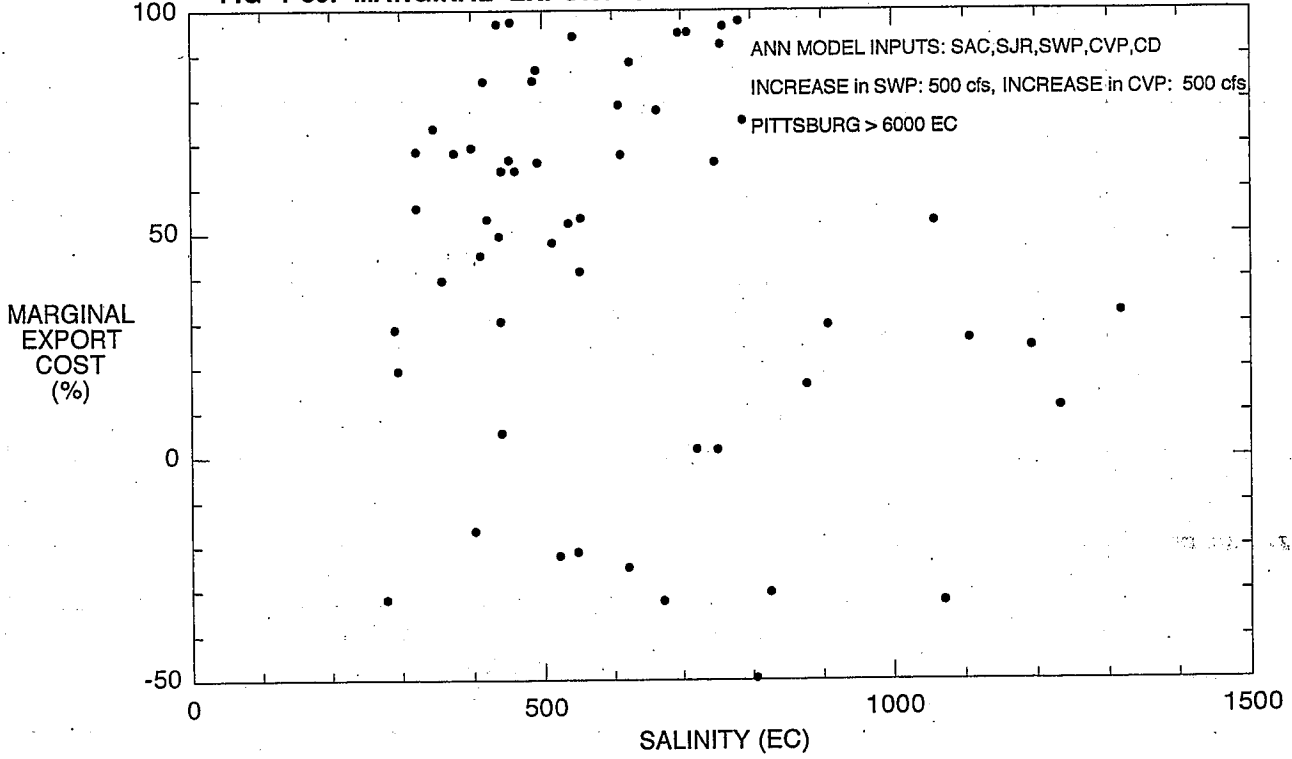
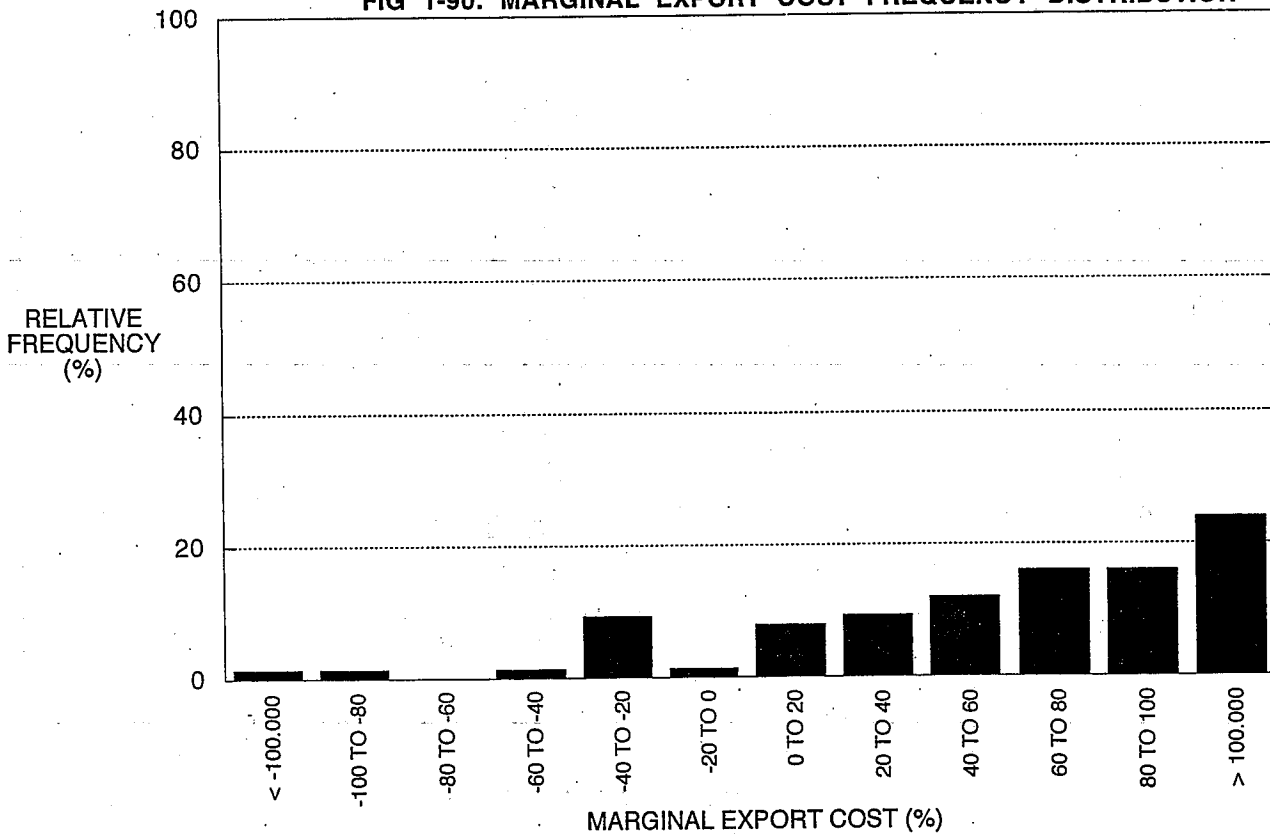
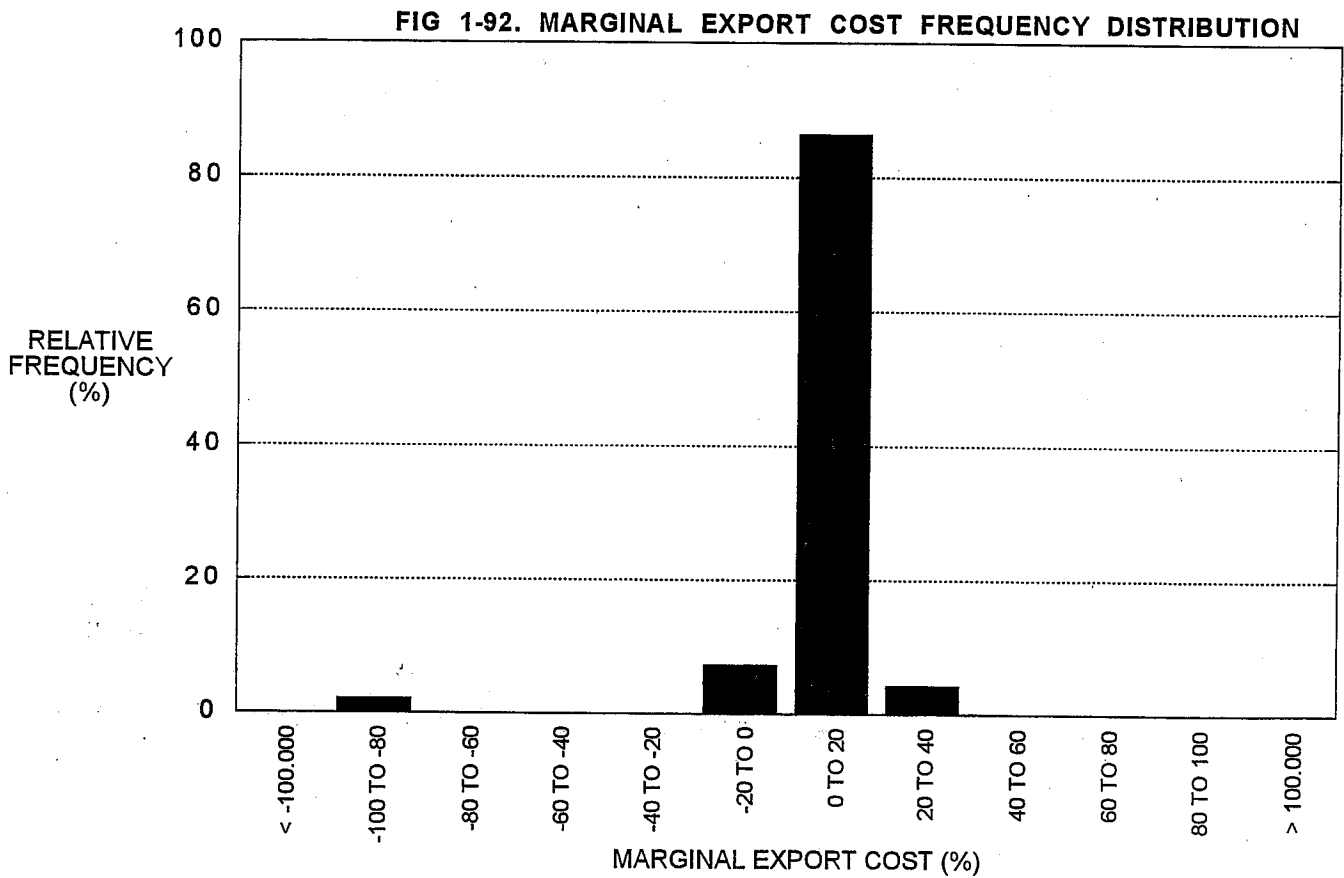
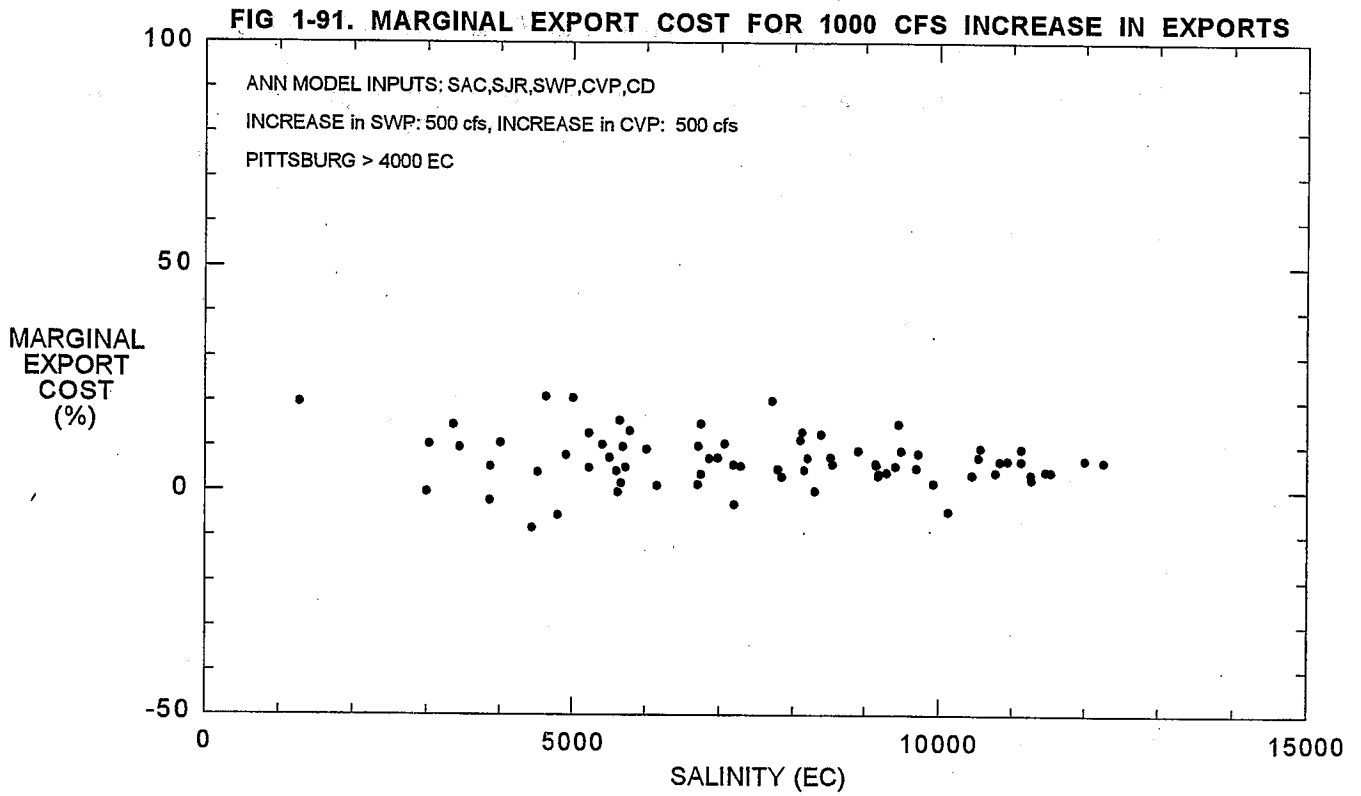

FIG 1-90. MARGINAL EXPORT COST FREQUENCY DISTRIBUTION



TRANSIENT IMPULSE MARGINAL EXPORT COST AT PITTSBURG

DSM DATA - ANN MULTIPLE INPUT MODEL



TRANSIENT IMPULSE MARGINAL EXPORT COST AT EMMATON

DSM DATA - ANN MULTIPLE INPUT MODEL

FIG 1-93. MARGINAL EXPORT COST FOR 1000 CFS INCREASE IN EXPORTS

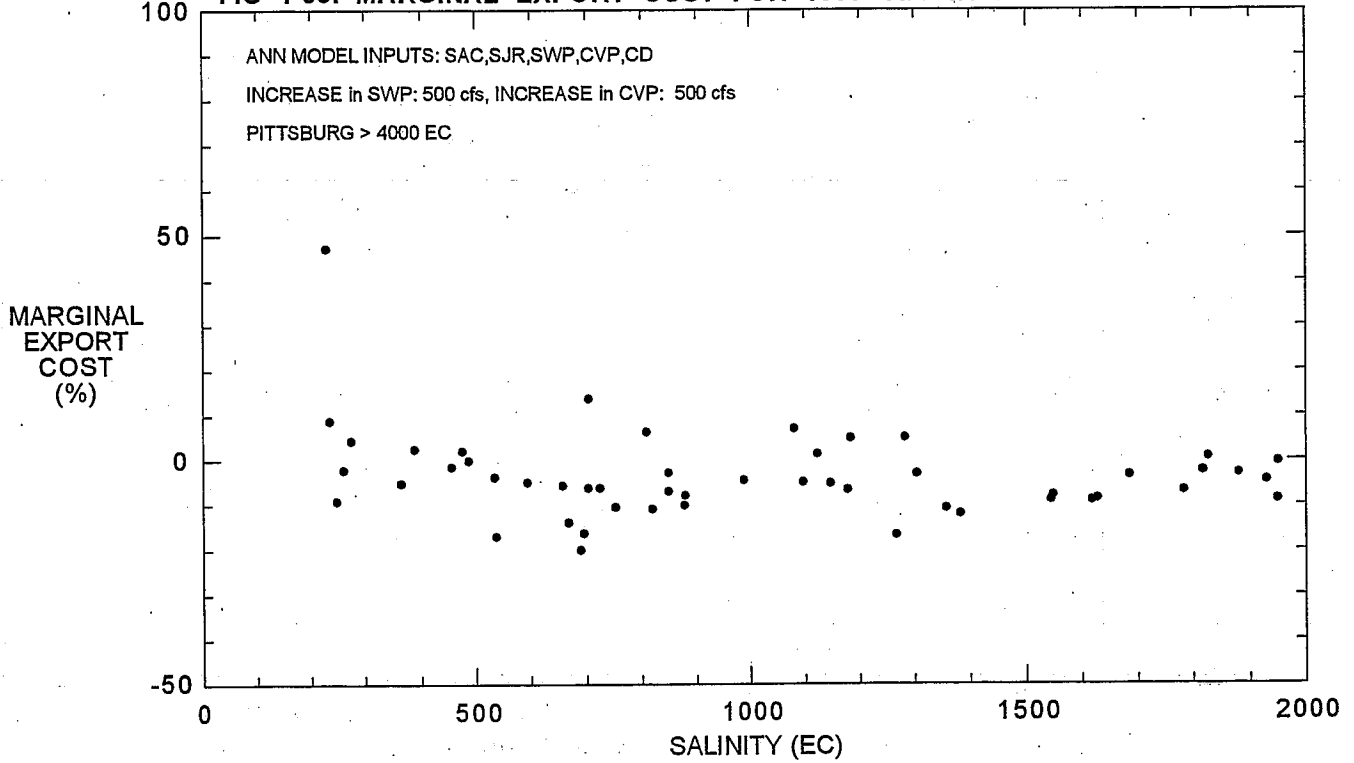
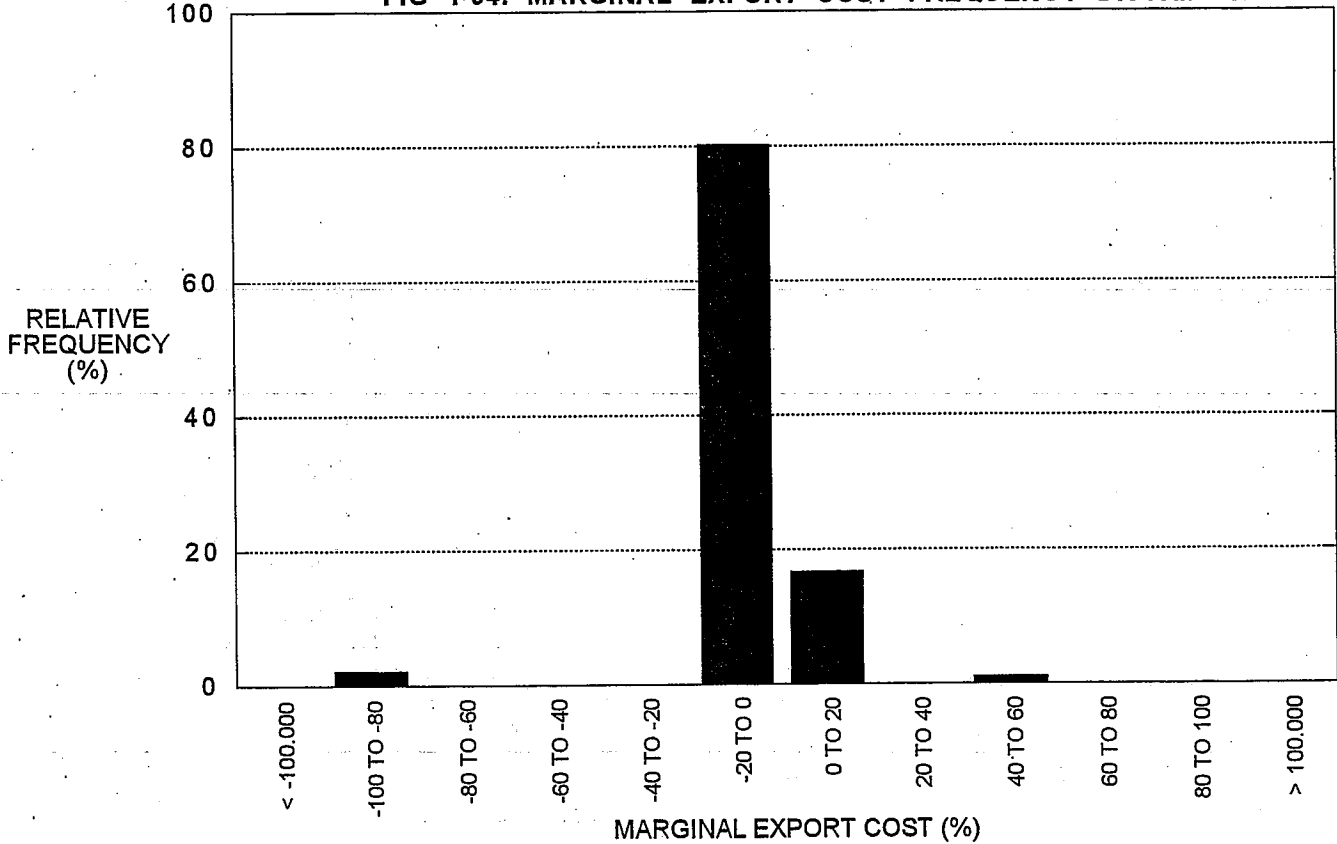
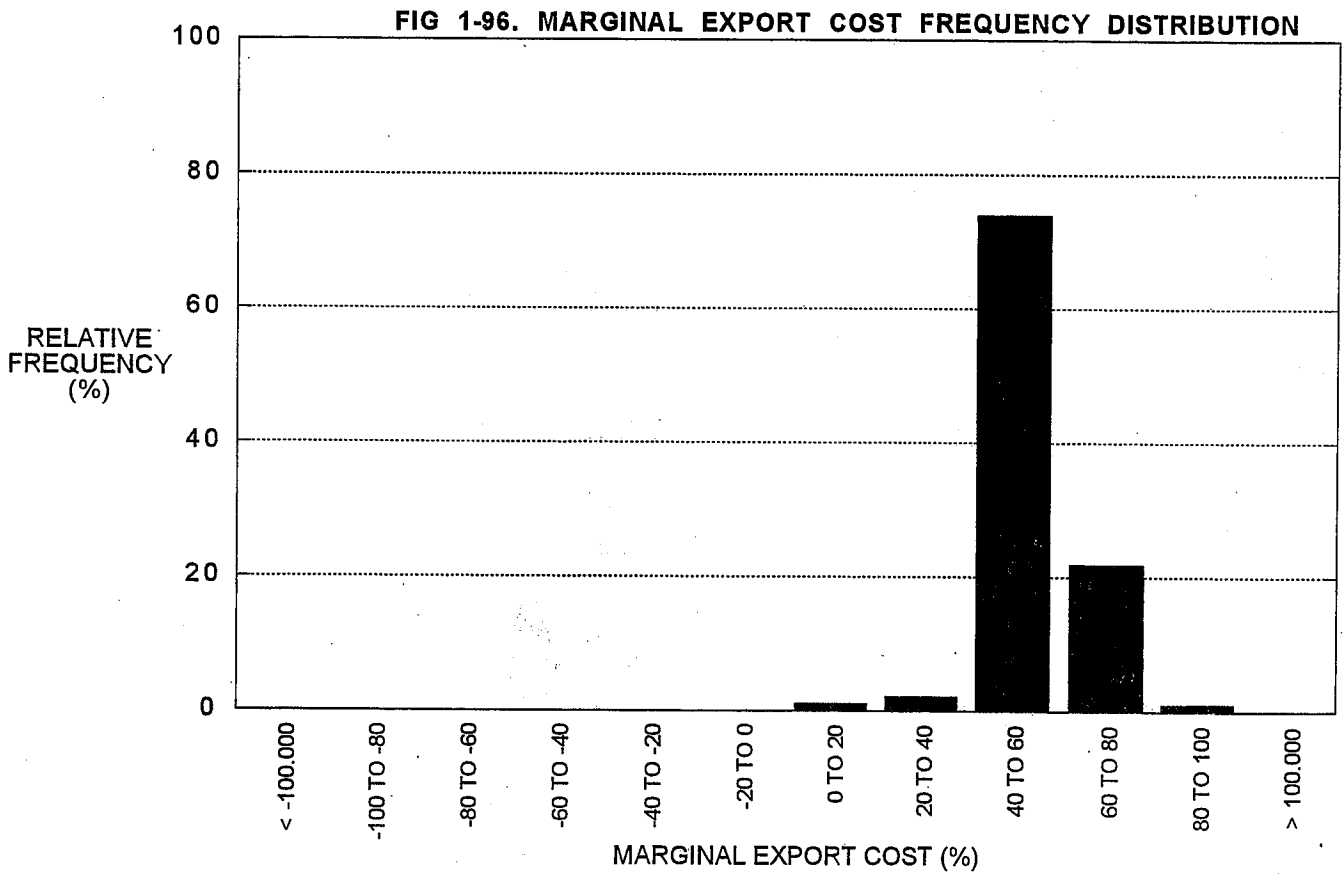
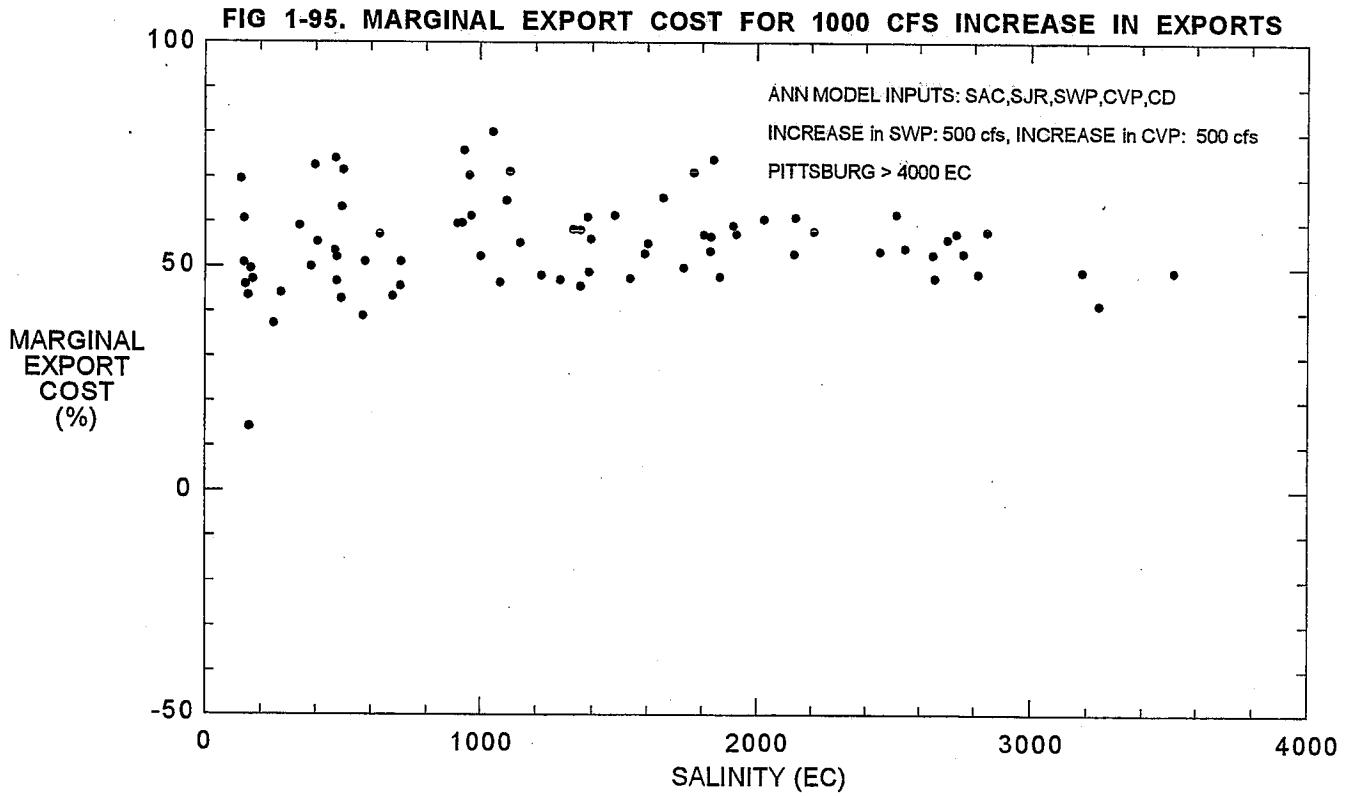

FIG 1-94. MARGINAL EXPORT COST FREQUENCY DISTRIBUTION



TRANSIENT IMPULSE MARGINAL EXPORT COST AT JERSEY POINT

DSM DATA - ANN MULTIPLE INPUT MODEL



TRANSIENT IMPULSE MARGINAL EXPORT COST AT CONTRA COSTA CANAL DSM DATA - ANN MULTIPLE INPUT MODEL

FIG 1-97. MARGINAL EXPORT COST FOR 1000 CFS INCREASE IN EXPORTS

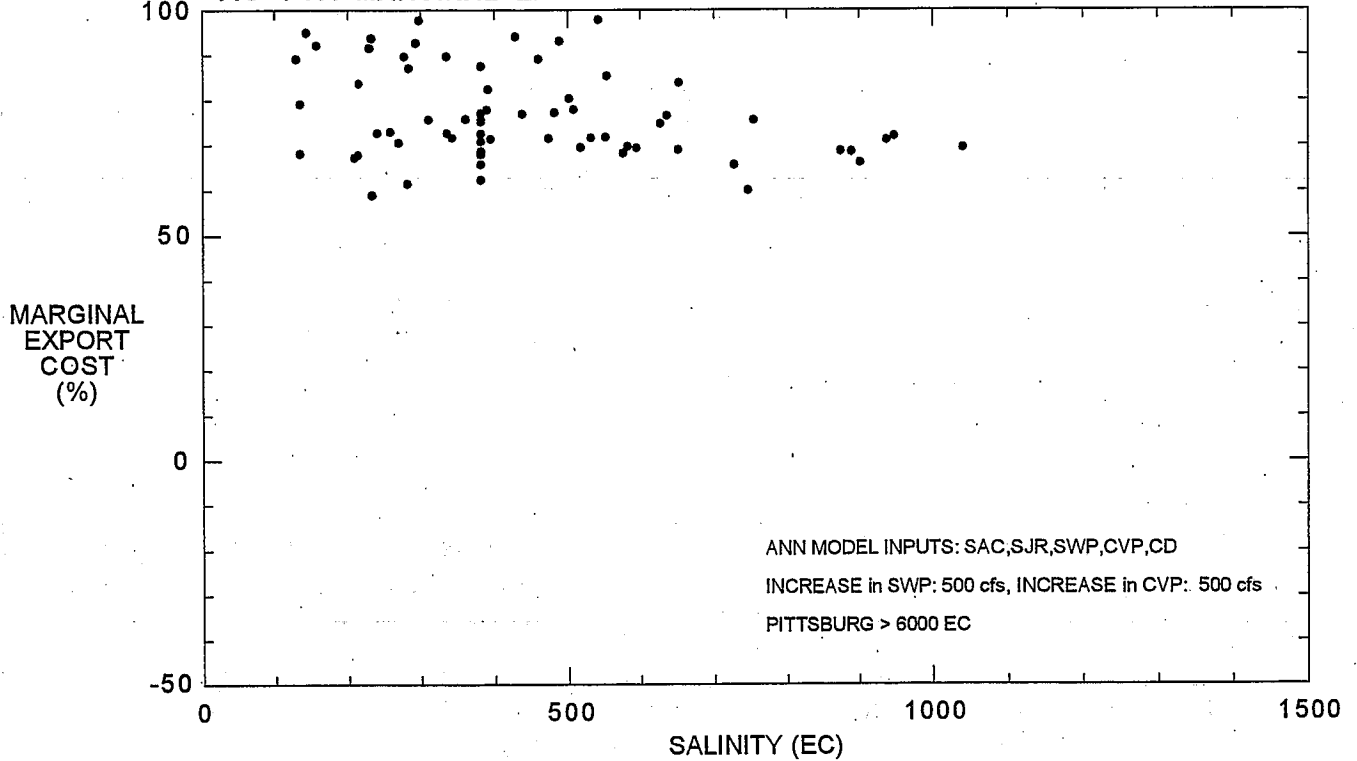
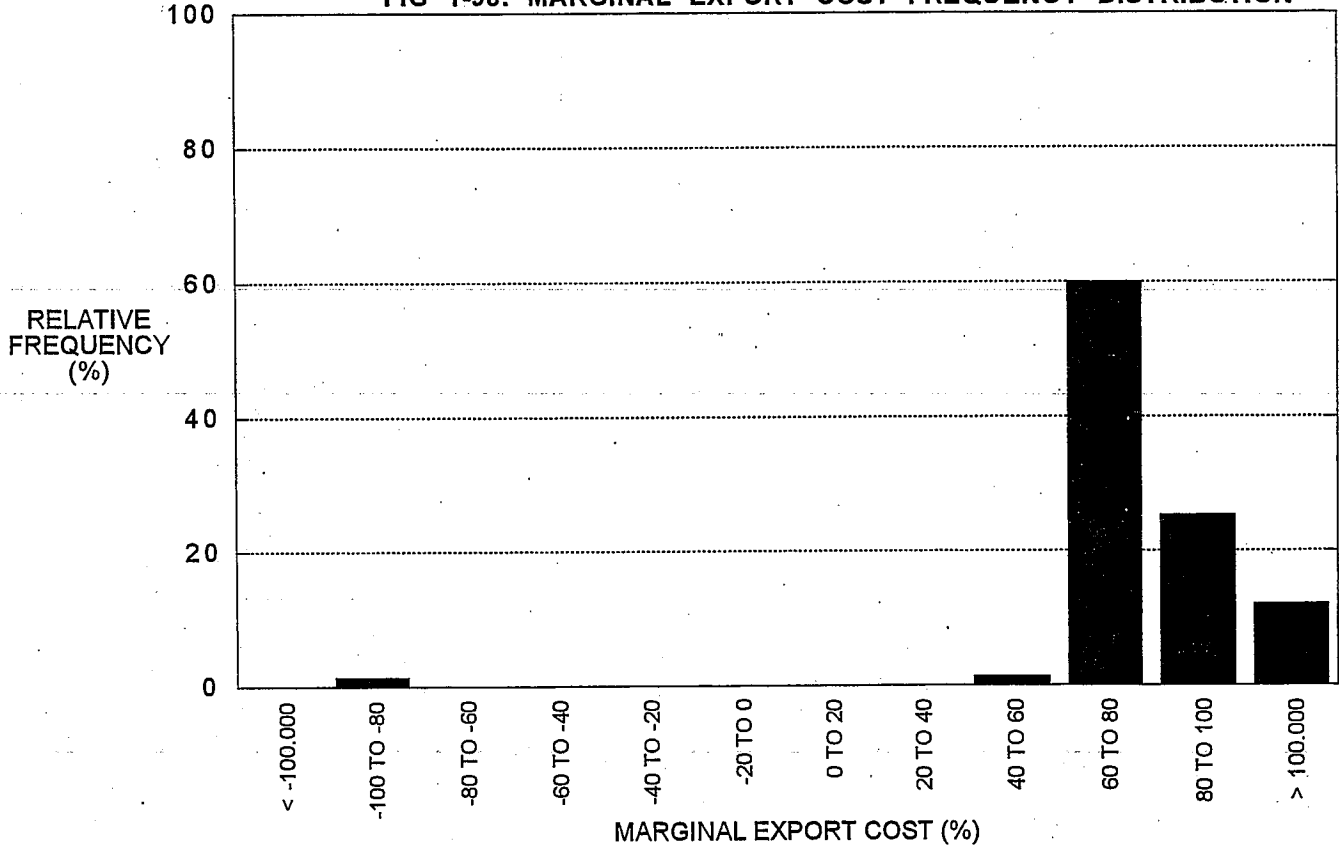

FIG 1-98. MARGINAL EXPORT COST FREQUENCY DISTRIBUTION



TRANSIENT IMPULSE MARGINAL EXPORT COST AT CLIFTON COURT FOREBAY DSM DATA - ANN MULTIPLE INPUT MODEL

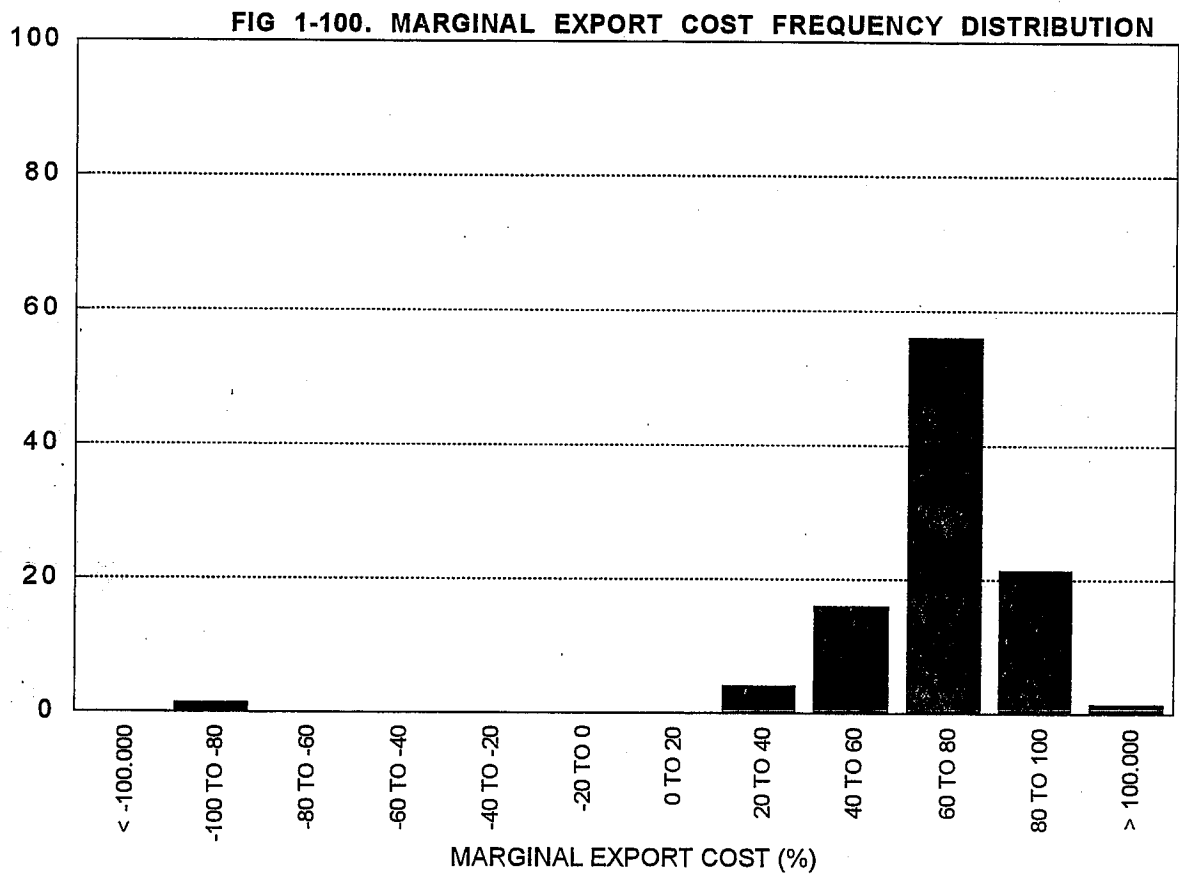
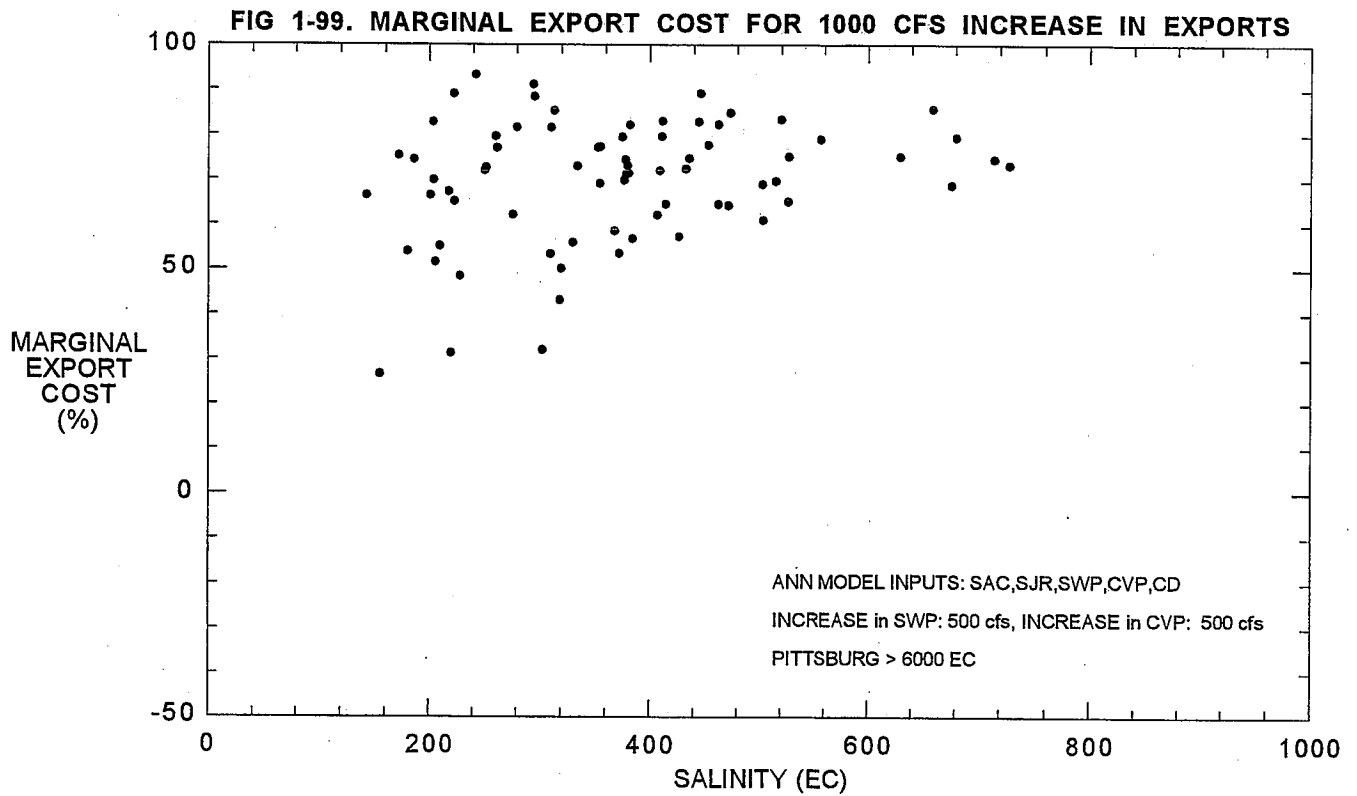
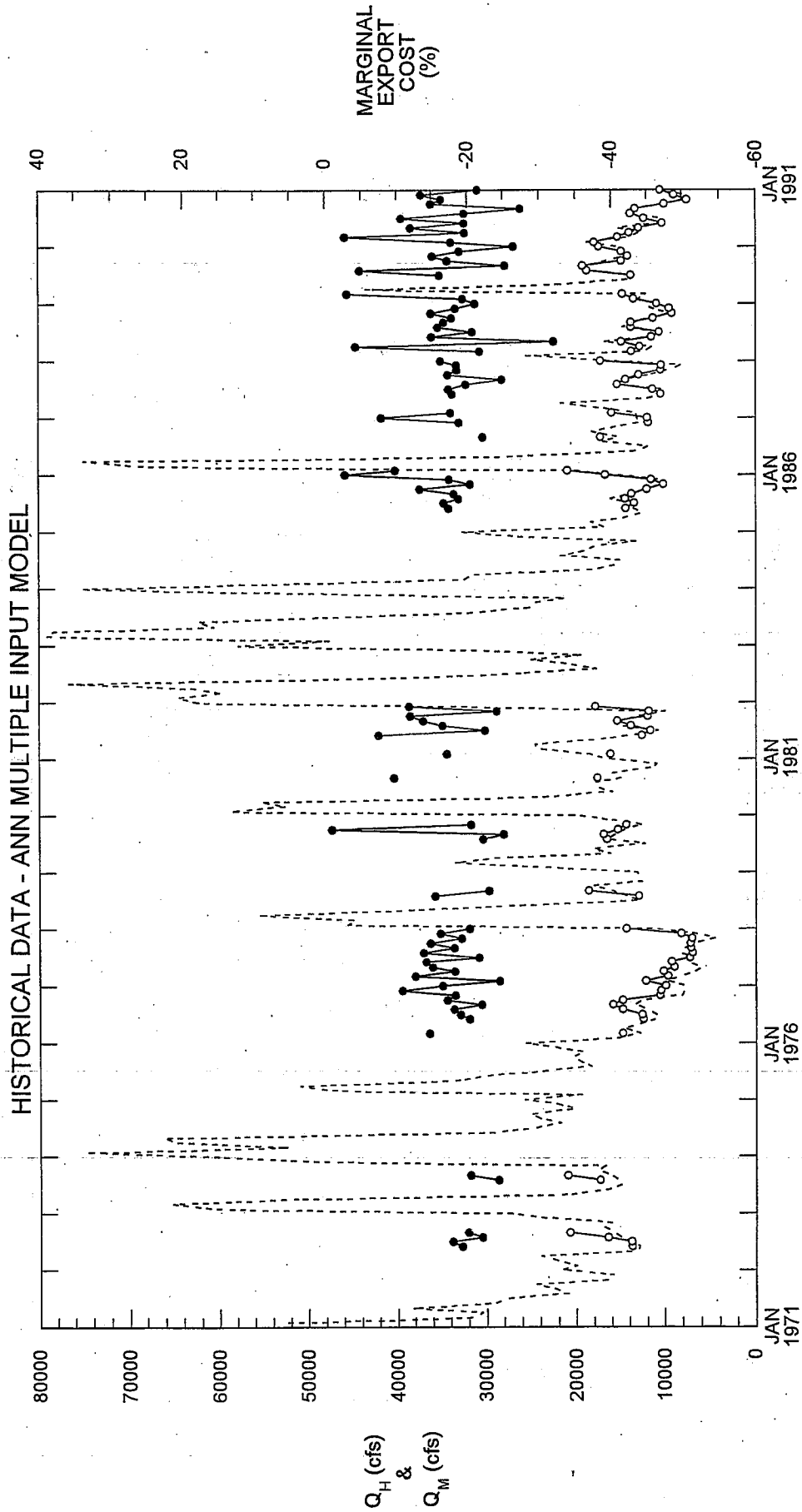

Figure 1-101

CONTINUOUS IMPULSE MARGINAL EXPORT COST AT PITTSBURG



--- (Q_H): HISTORICAL SAC
—○— (Q_M): MODEL CALCULATED SAC
—●— MARGINAL EXPORT COST

--- INCREASE in SWP: 500 cfs, INCREASE in CVP: 500 cfs
--- PITTSBURG > 4000 EC

Figure 1-102
TIME SERIES PLOT
CONTINUOUS IMPULSE MARGINAL EXPORT COST
AT EMMATON

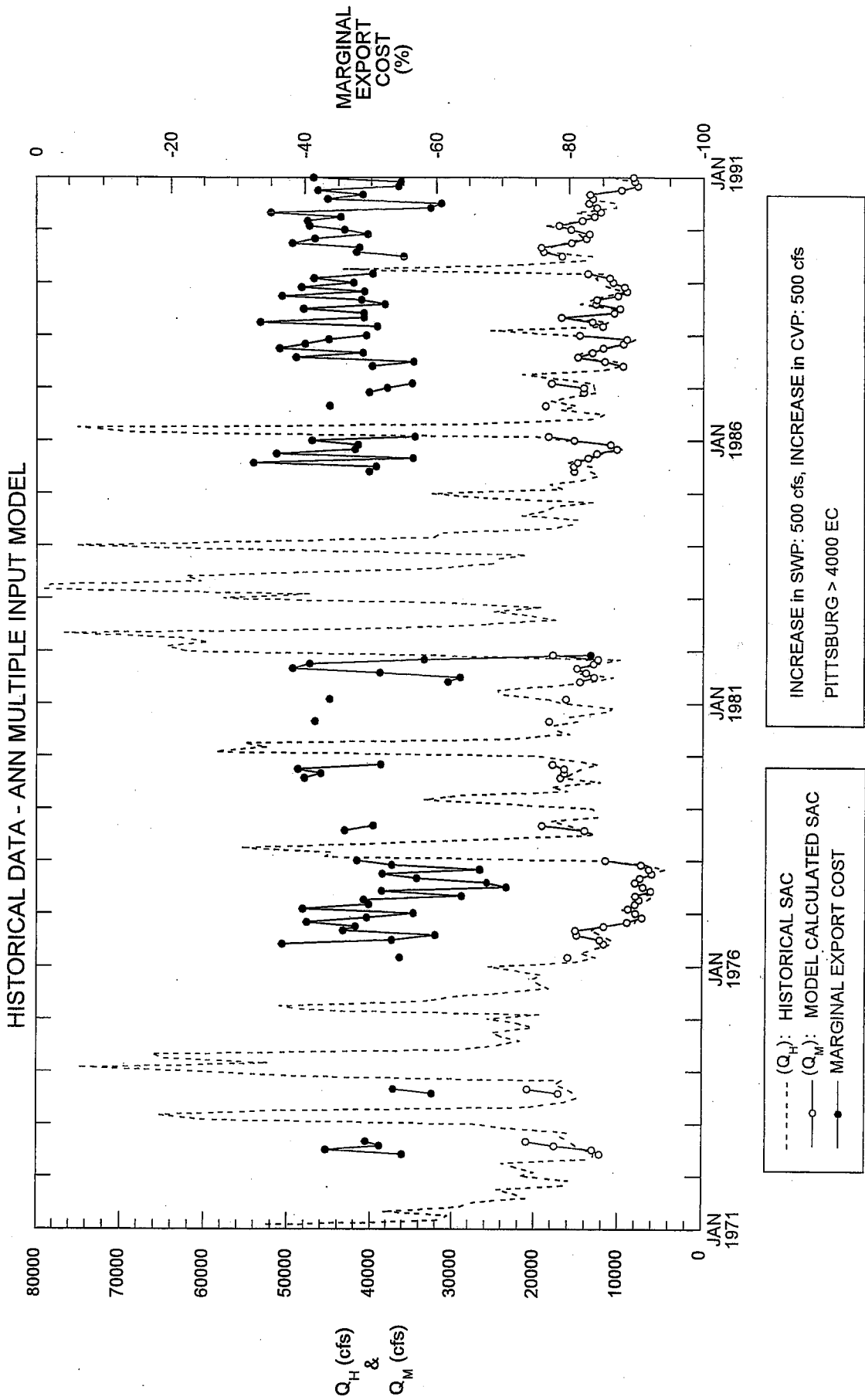
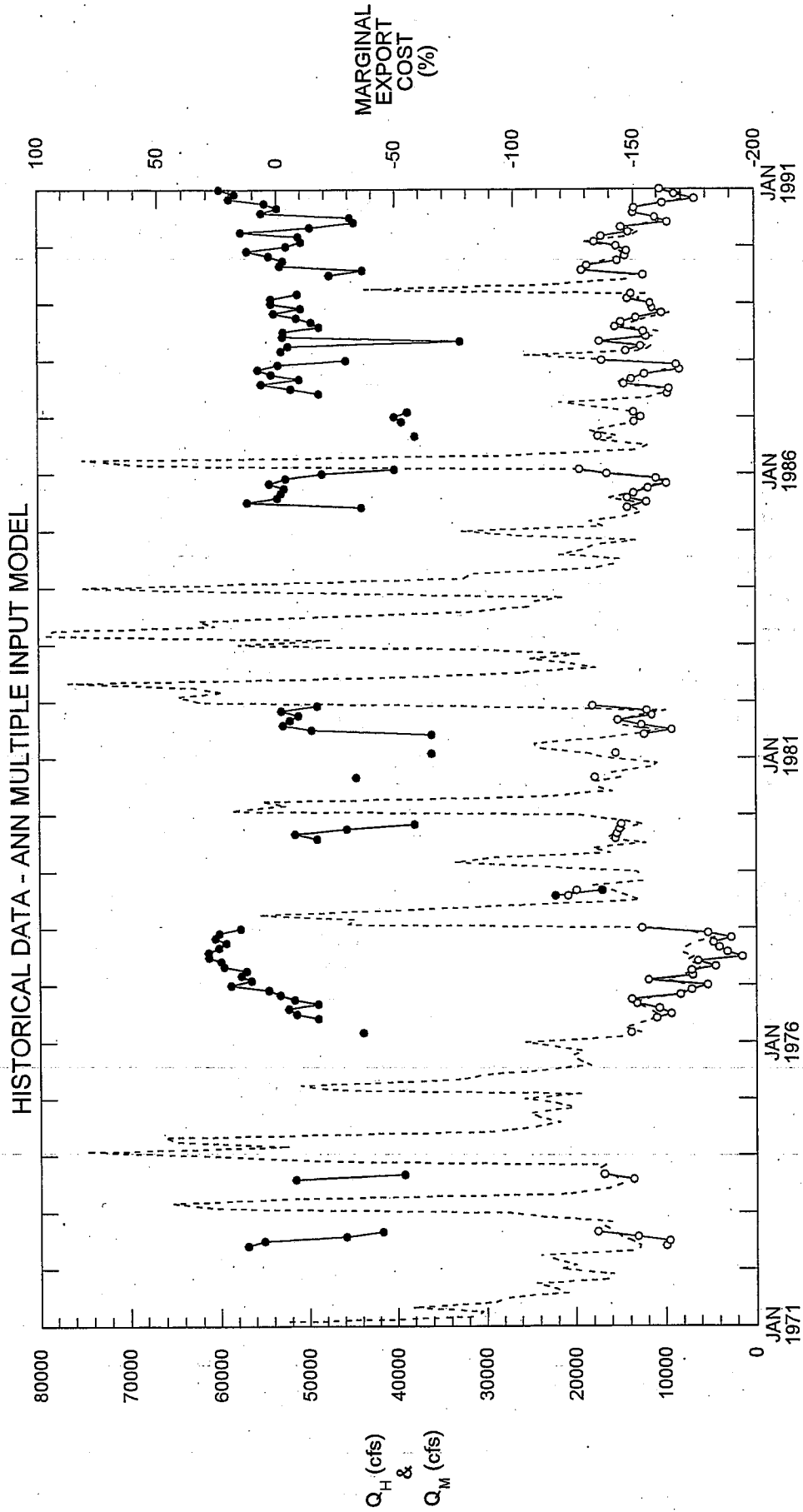

Figure 1-103
TIME SERIES PLOT
CONTINUOUS IMPULSE MARGINAL EXPORT COST
AT JERSEY POINT



--- (Q_H): HISTORICAL SAC
 —○— (Q_M): MODEL CALCULATED SAC
 —●— MARGINAL EXPORT COST

--- INCREASE in SWP: 500 cfs, INCREASE in CVP: 500 cfs
 ····· PITTSBURG > 4000 EC

Figure 1-104
TIME SERIES PLOT
CONTINUOUS IMPULSE MARGINAL EXPORT COST
AT CONTRA COSTA CANAL

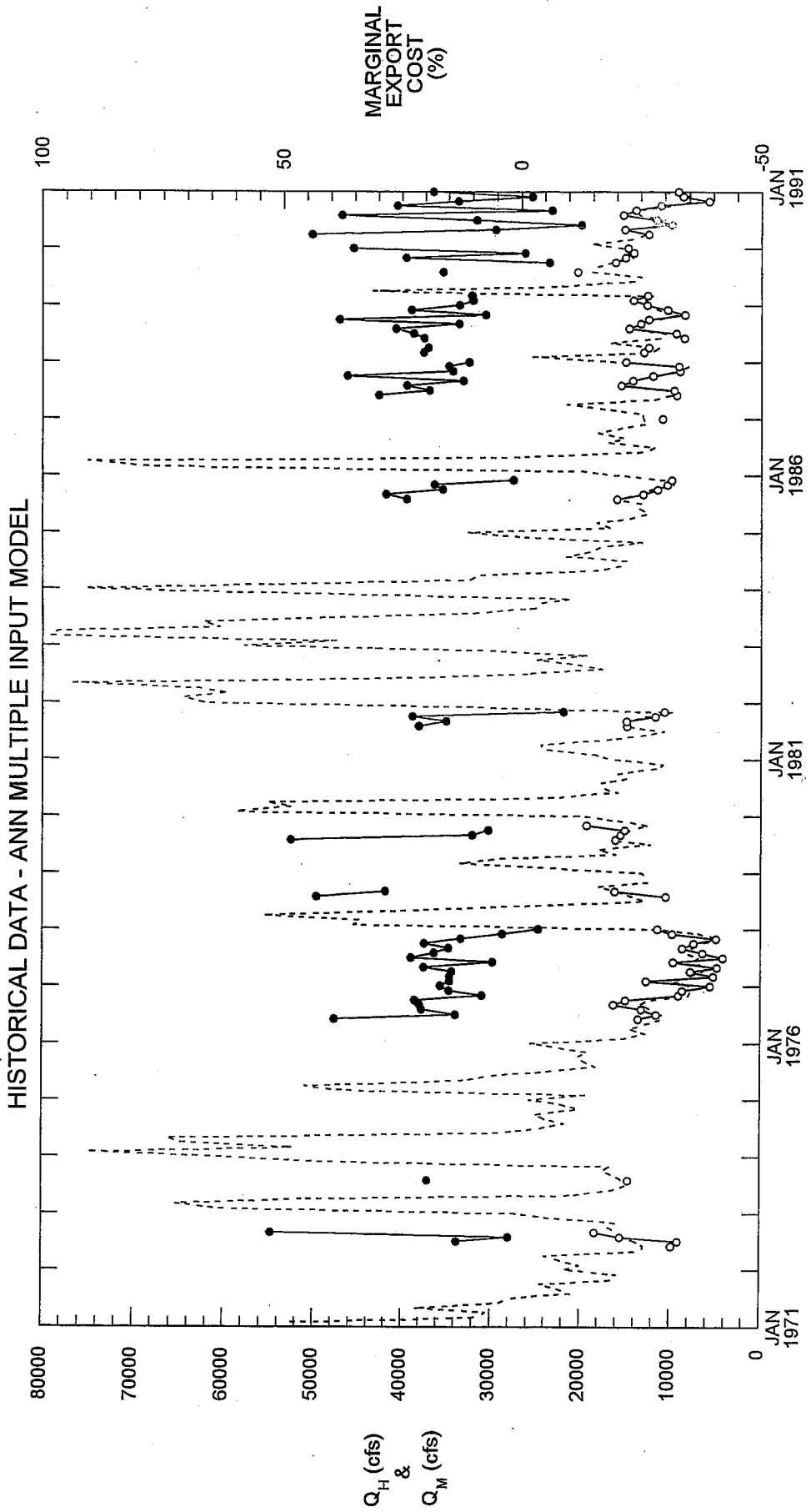

--- (Q_H): HISTORICAL SAC
 -○- (Q_M): MODEL CALCULATED SAC
 -●- MARGINAL EXPORT COST

--- INCREASE in SWP: 500 cfs, INCREASE in CVP: 500 cfs
 --- PITTSBURG > 6000 EC

Figure 1-105
TIME SERIES PLOT
CONTINUOUS IMPULSE MARGINAL EXPORT COST
AT CLIFTON COURT FOREBAY
 HISTORICAL DATA - ANN MULTIPLE INPUT MODEL

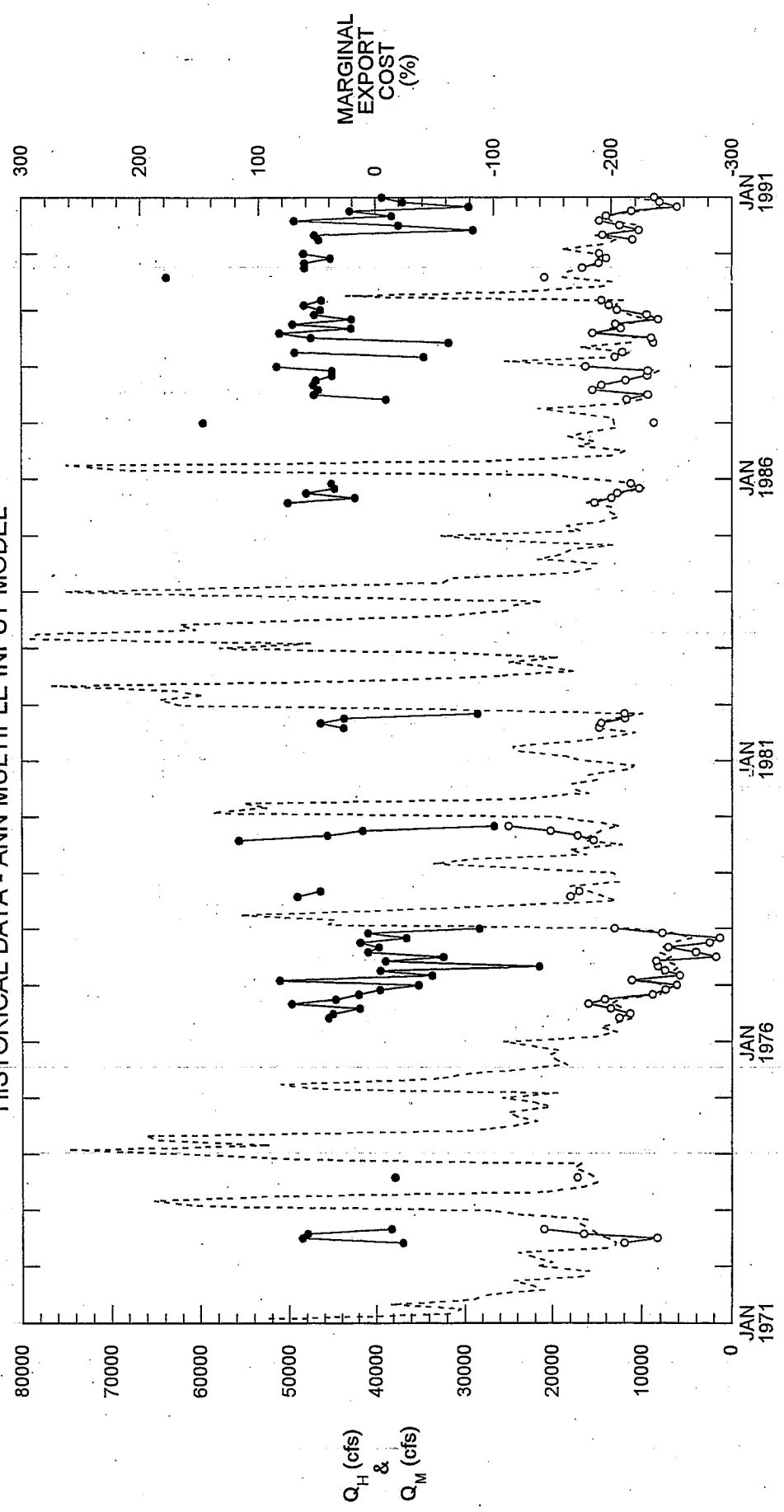

--- (Q_H): HISTORICAL SAC
 —○— (Q_M): MODEL CALCULATED SAC
 —●— MARGINAL EXPORT COST

--- INCREASE in SWP: 500 cfs, INCREASE in CVP: 500 cfs
 --- PITTSBURG > 6000 EC

Figure 1-106
TIME SERIES PLOT
CONTINUOUS IMPULSE MARGINAL EXPORT COST
AT PITTSBURG

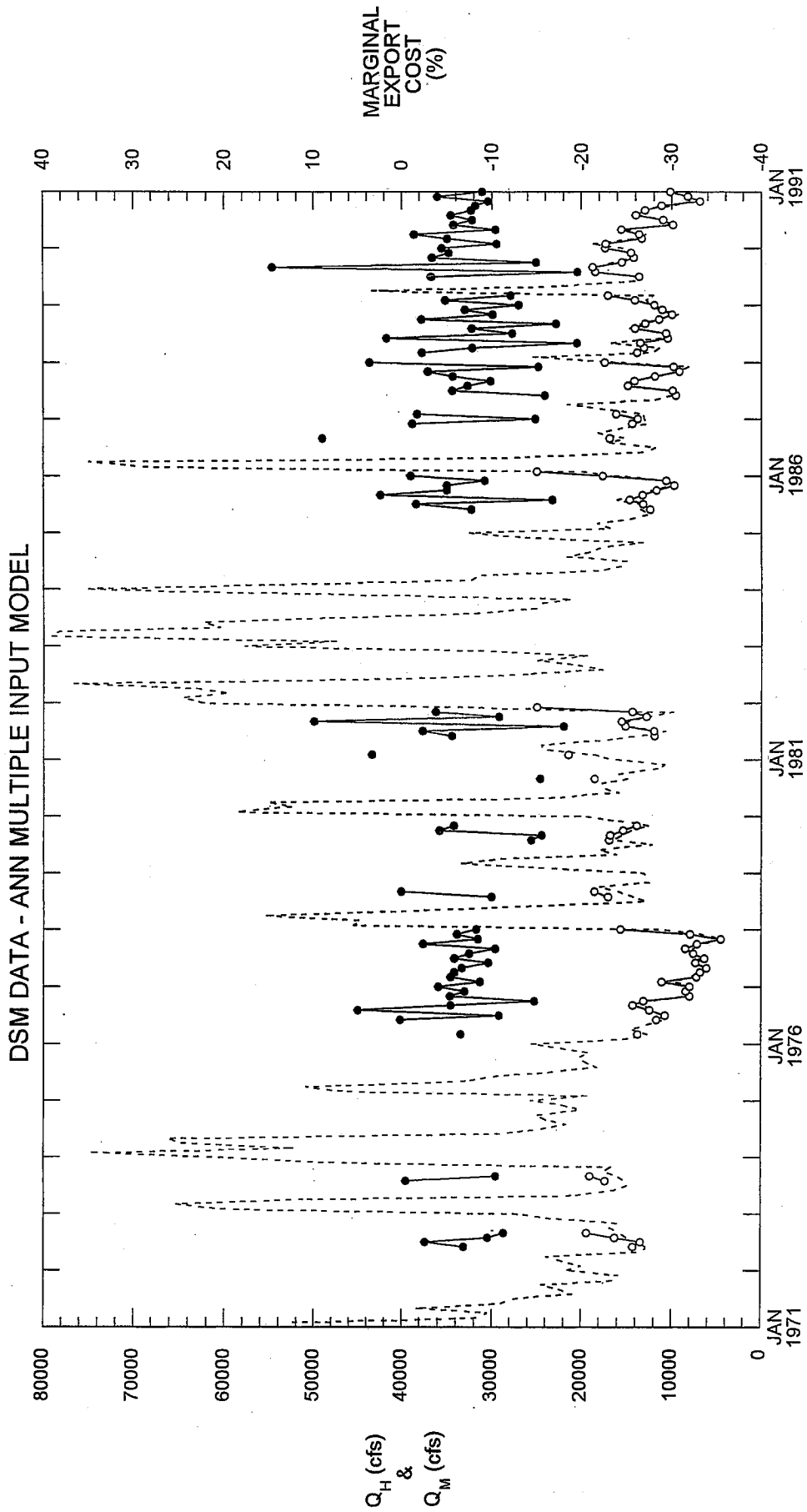

--- (Q_H): HISTORICAL SAC
 —○— (Q_M): MODEL CALCULATED SAC
 —●— MARGINAL EXPORT COST

--- INCREASE in SWP: 500 cfs, INCREASE in CVP: 500 cfs
 PITTSBURG > 4000 EC

Figure 107
TIME SERIES PLOT
CONTINUOUS IMPULSE MARGINAL EXPORT COST
AT EMMATON
 DSM DATA - ANN MULTIPLE INPUT MODEL

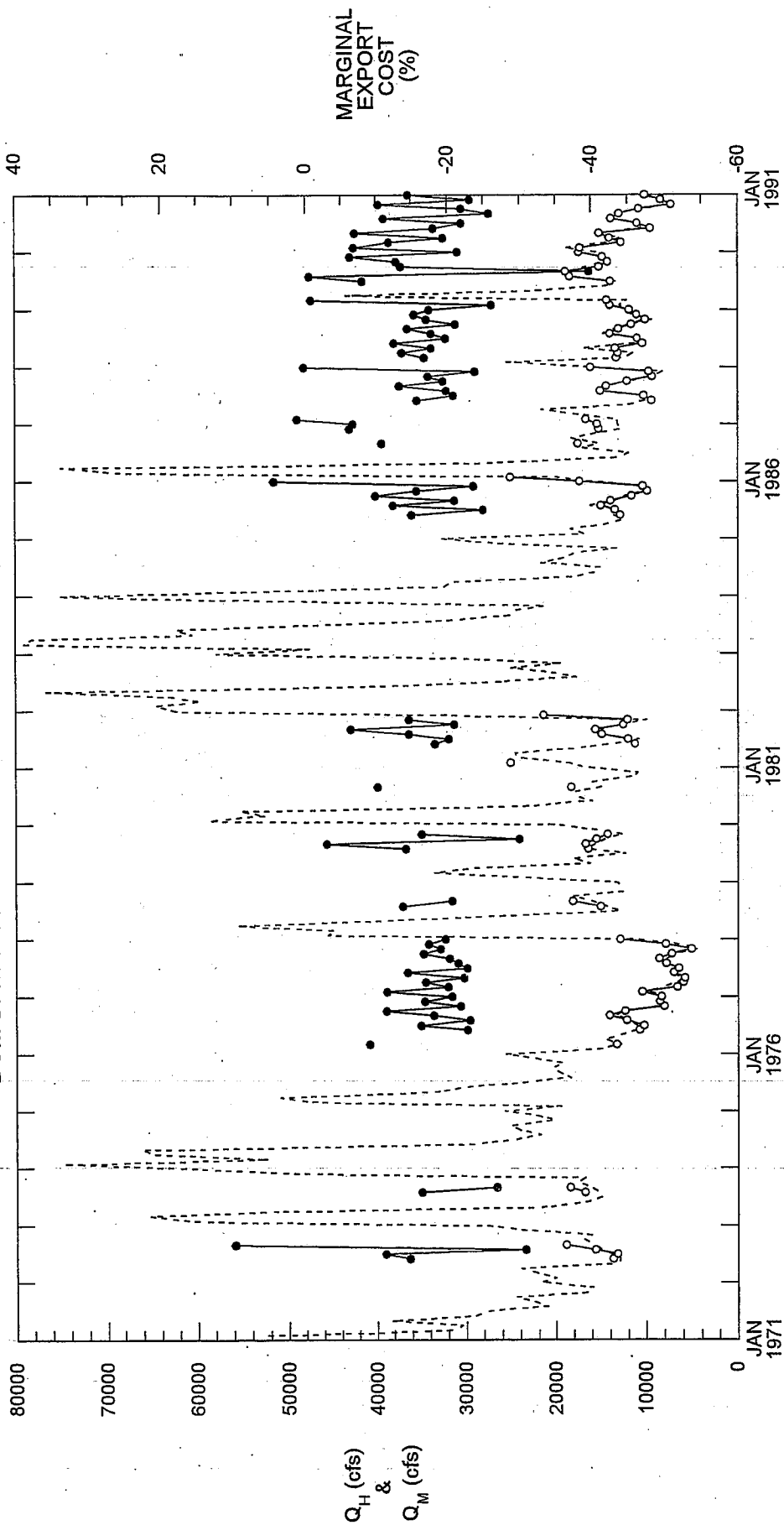

--- (Q_H): HISTORICAL SAC
 —○— (Q_M): MODEL CALCULATED SAC
 —●— MARGINAL EXPORT COST

INCREASE in SWP: 500 cfs, INCREASE in CVP: 500 cfs
 PITTSBURG > 4000 EC

Figure 1-108
TIME SERIES PLOT
CONTINUOUS IMPULSE MARGINAL EXPORT COST
AT JERSEY POINT
 DSM DATA - ANN MULTIPLE INPUT MODEL

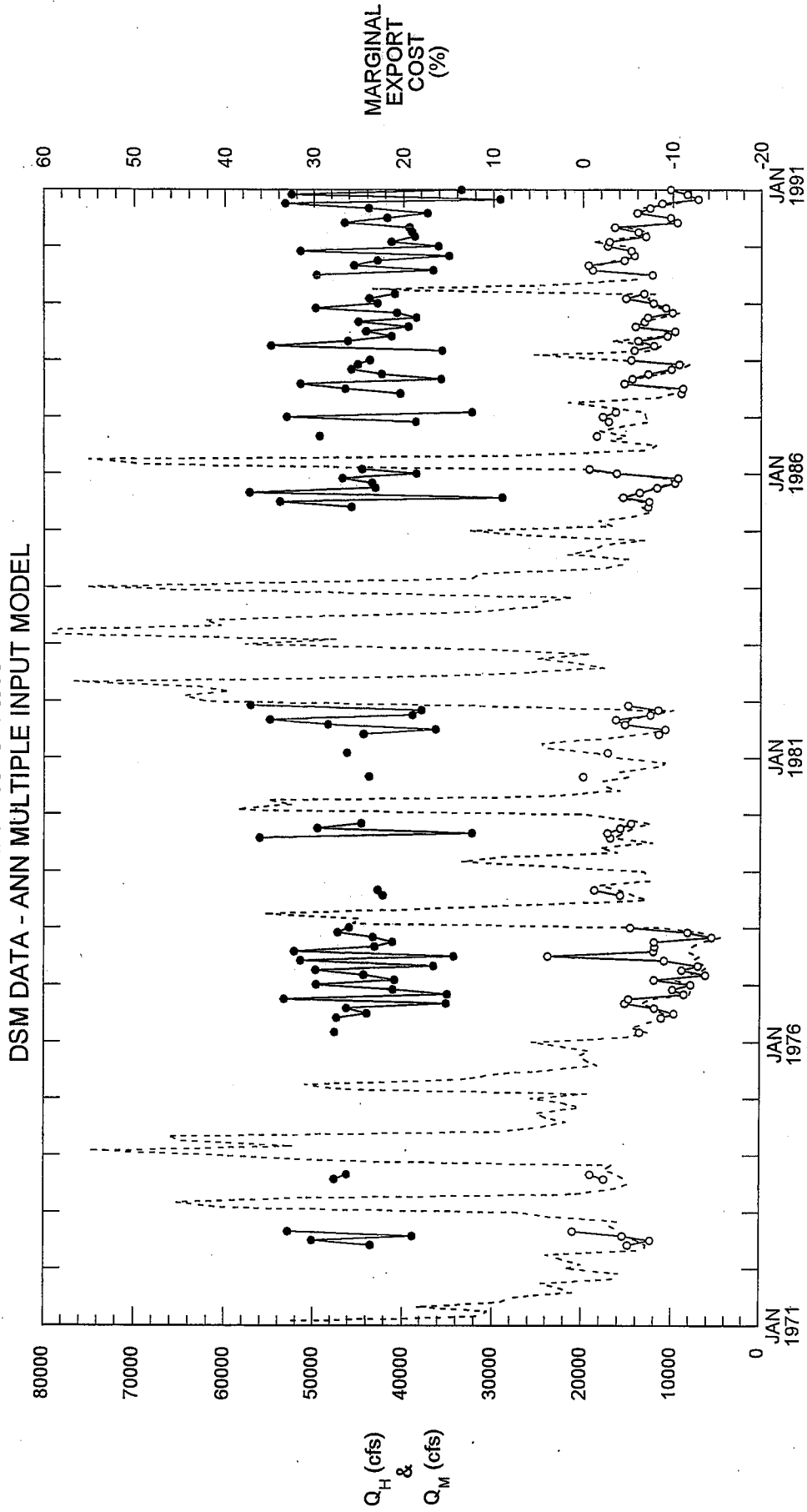

INCREASE in SWP: 500 cfs, INCREASE in CVP: 500 cfs
 PITTSBURG > 4000 EC

--- (Q_H): HISTORICAL SAC
 —○— (Q_M): MODEL CALCULATED SAC
 —●— MARGINAL EXPORT COST

Figure 1-109
TIME SERIES PLOT
CONTINUOUS IMPULSE MARGINAL EXPORT COST
AT CONTRA COSTA CANAL
 DSM DATA - ANN MULTIPLE INPUT MODEL

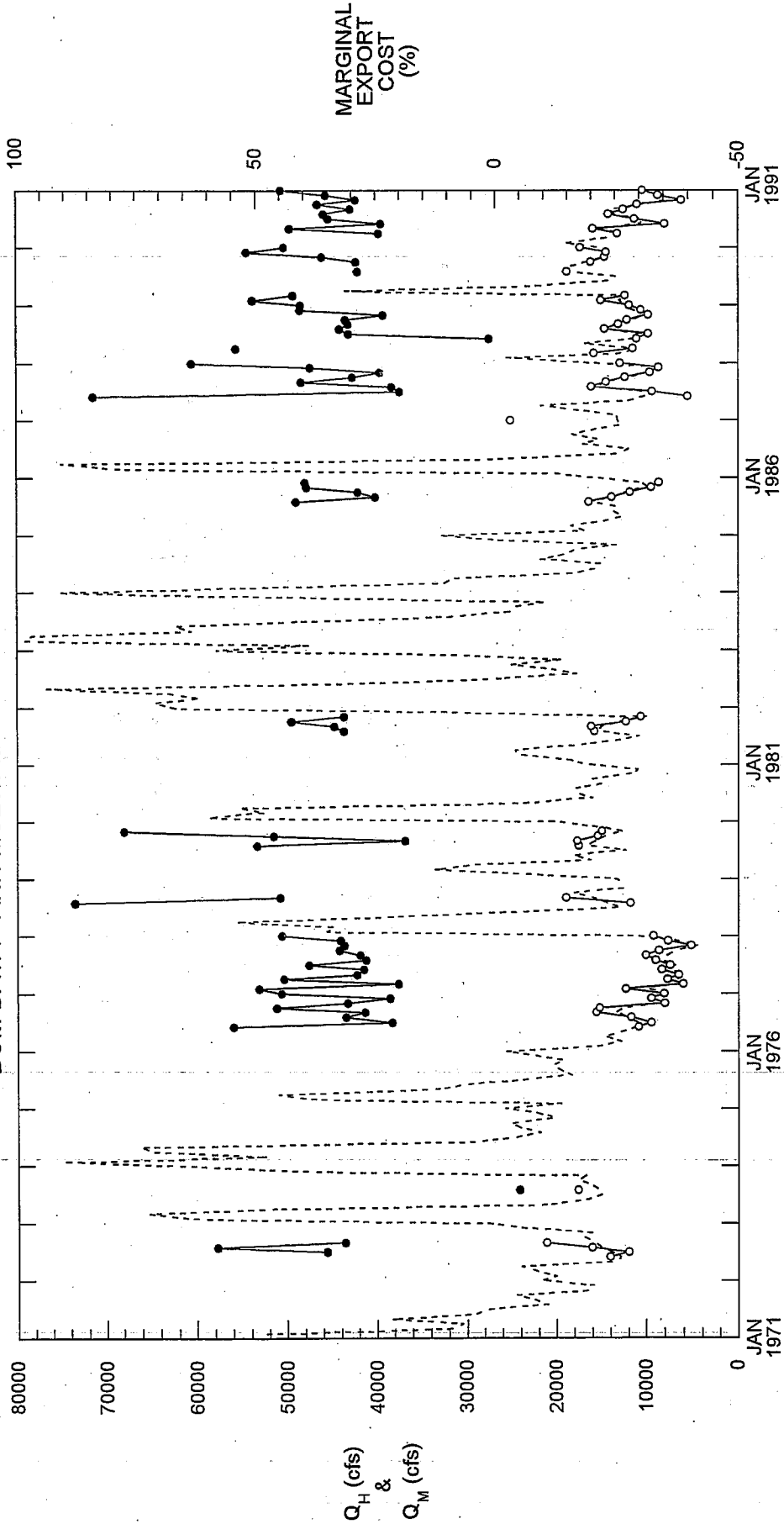

--- (Q_H): HISTORICAL SAC
 —○— (Q_M): MODEL CALCULATED SAC
 —●— MARGINAL EXPORT COST

INCREASE in SWP: 500 cfs, INCREASE in CVP: 500 cfs
 PITTSBURG > 6000 EC

Figure 1-110
TIME SERIES PLOT
CONTINUOUS IMPULSE MARGINAL EXPORT COST
AT CLIFTON COURT FOREBAY
 DSM DATA - ANN MULTIPLE INPUT MODEL

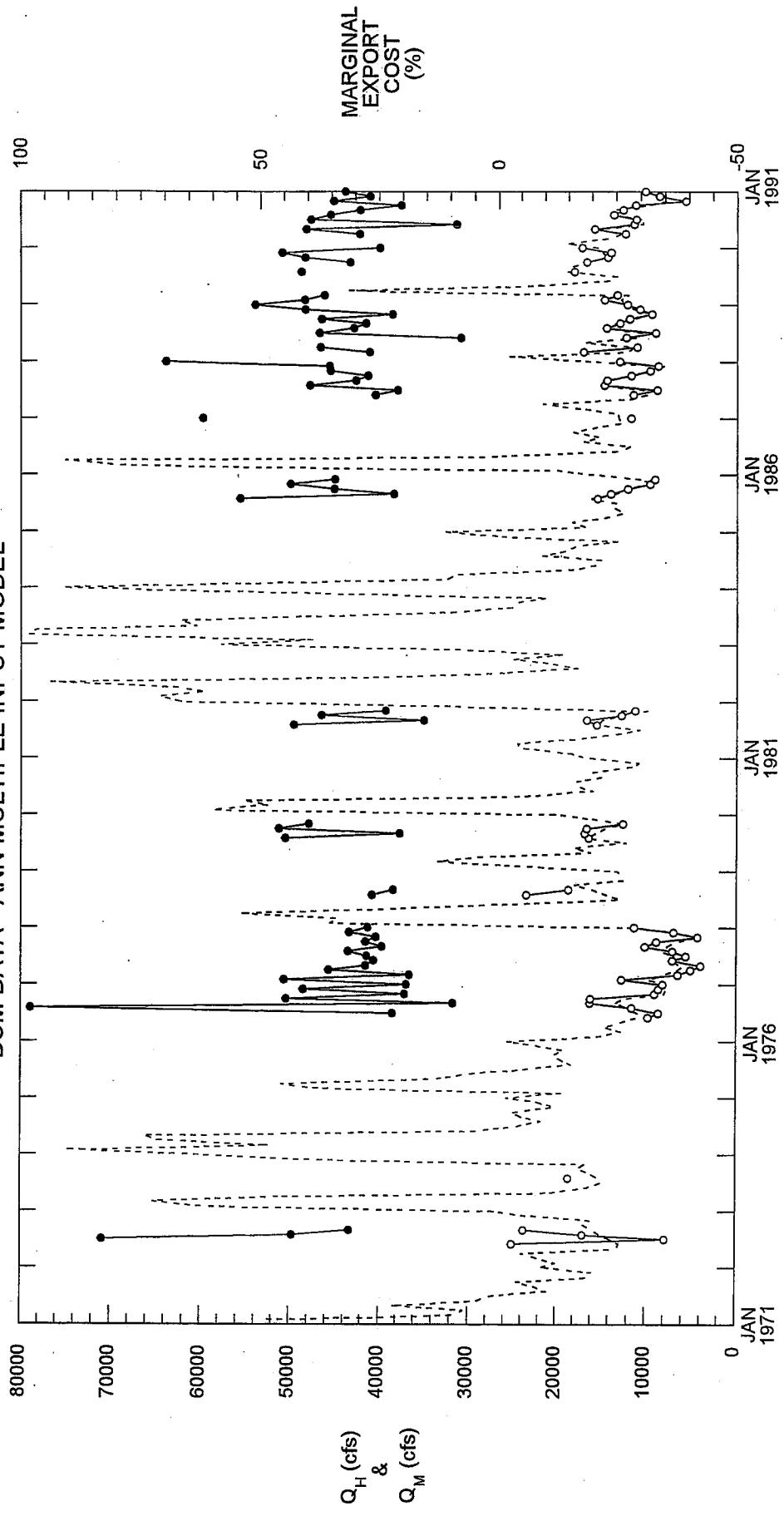

--- (Q_H): HISTORICAL SAC
 -○- (Q_M): MODEL CALCULATED SAC
 -●- MARGINAL EXPORT COST

INCREASE IN SWP: 500 cfs, INCREASE IN CVP: 500 cfs
 PITTSBURG > 6000 EC

Figure 1-111
**TRANSIENT IMPULSE MARGINAL EXPORT COST
 TIME SERIES PLOT
 AT PITTSBURG**

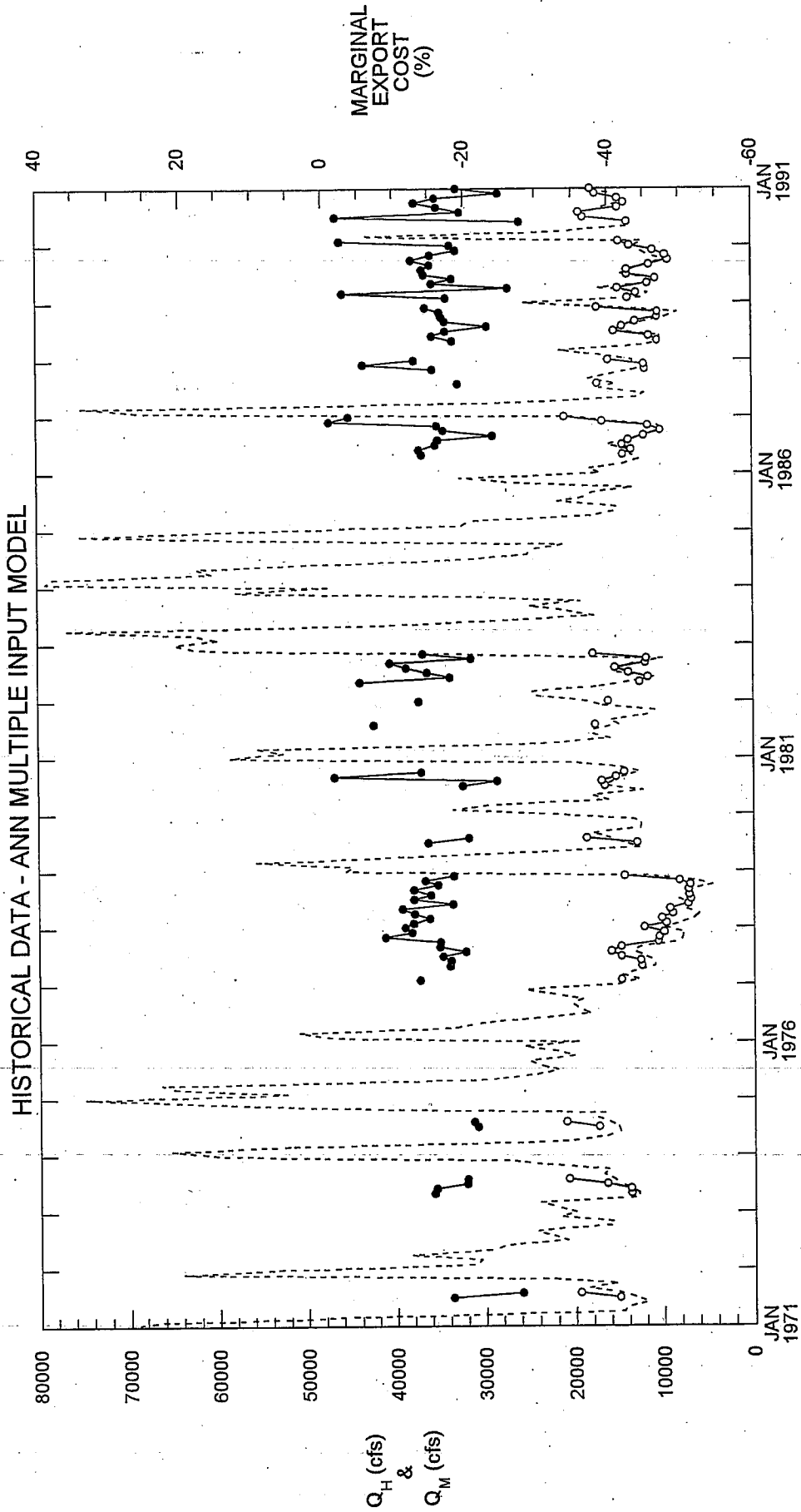

INCREASE in SWP: 500 cfs,
 INCREASE in CVP: 500 cfs
 PITTSBURG > 4000 EC

--- (Q_H): HISTORICAL SAC
 —○— (Q_M): MODEL CALCULATED SAC
 —●— MARGINAL EXPORT COST

Figure 1-112
**TRANSIENT IMPULSE MARGINAL EXPORT COST
 AT EMMATON**
 TIME SERIES PLOT
 HISTORICAL DATA - ANN MULTIPLE INPUT MODEL

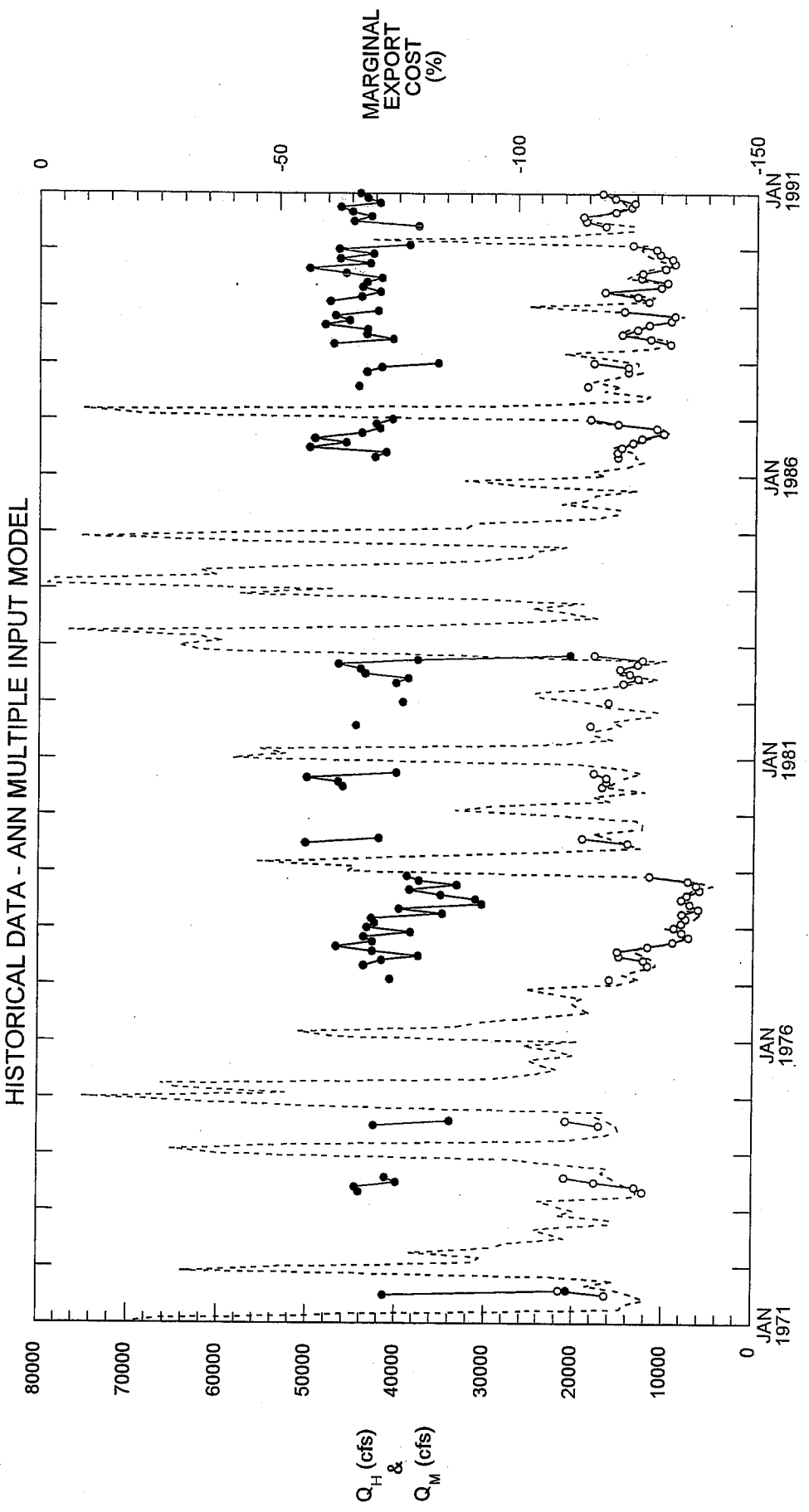

--- (Q_H): HISTORICAL SAC
 —○— (Q_M): MODEL CALCULATED SAC
 —●— MARGINAL EXPORT COST

INCREASE in SWP: 500 cfs, INCREASE in CVP: 500 cfs
 PITTSBURG > 4000 EC

Figure 1-113

**TIME SERIES PLOT
TRANSIENT IMPULSE MARGINAL EXPORT COST
AT JERSEY POINT**

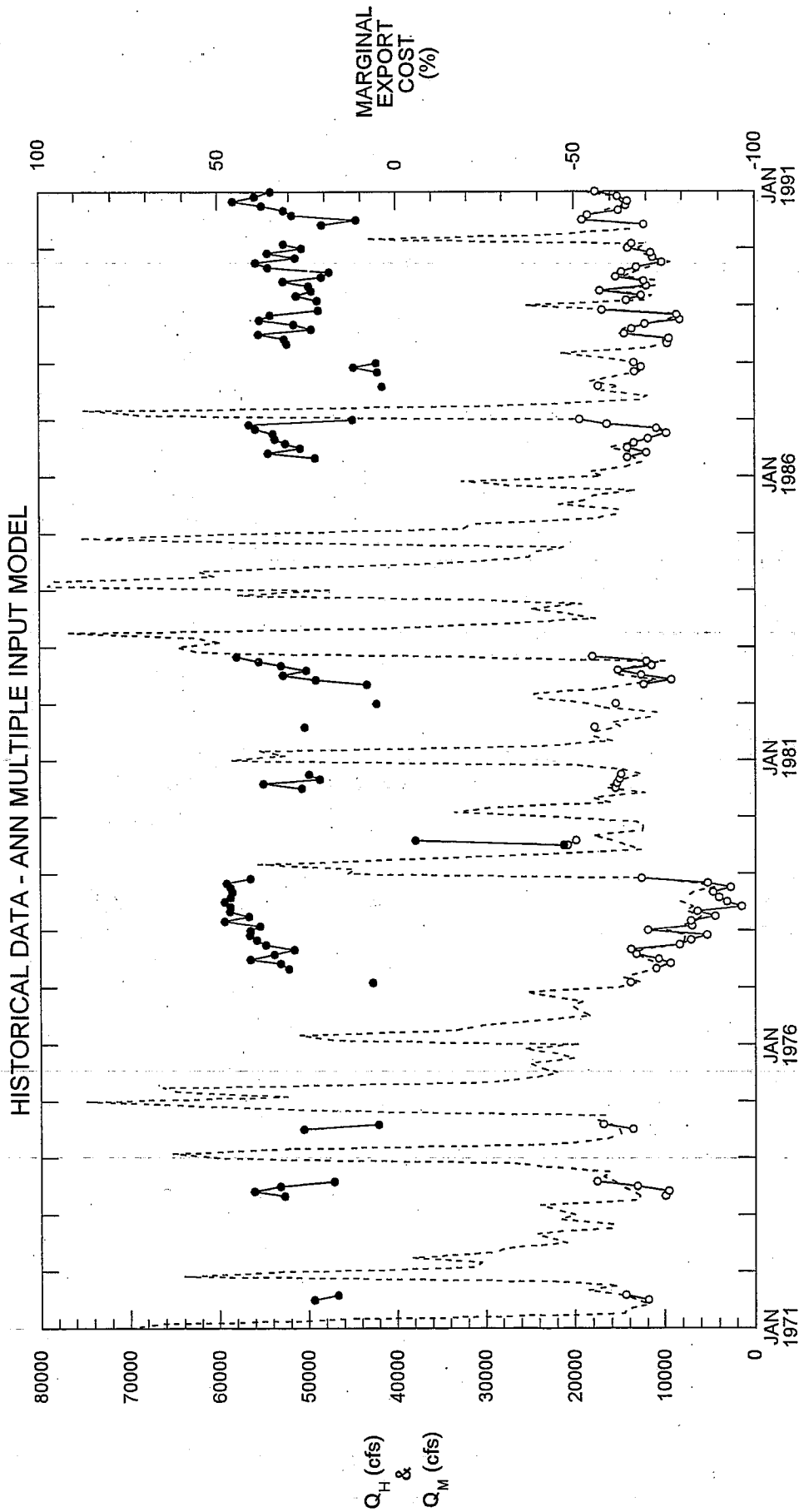

--- (Q_H): HISTORICAL SAC
 ○ (Q_M): MODEL CALCULATED SAC
 ● MARGINAL EXPORT COST

INCREASE in SWP: 500 cfs, INCREASE in CVP: 500 cfs
 PITTSBURG > 4000 EC

Figure 1-114

**TIME SERIES PLOT
TRANSIENT IMPULSE MARGINAL EXPORT COST
AT CONTRA COSTA CANAL**

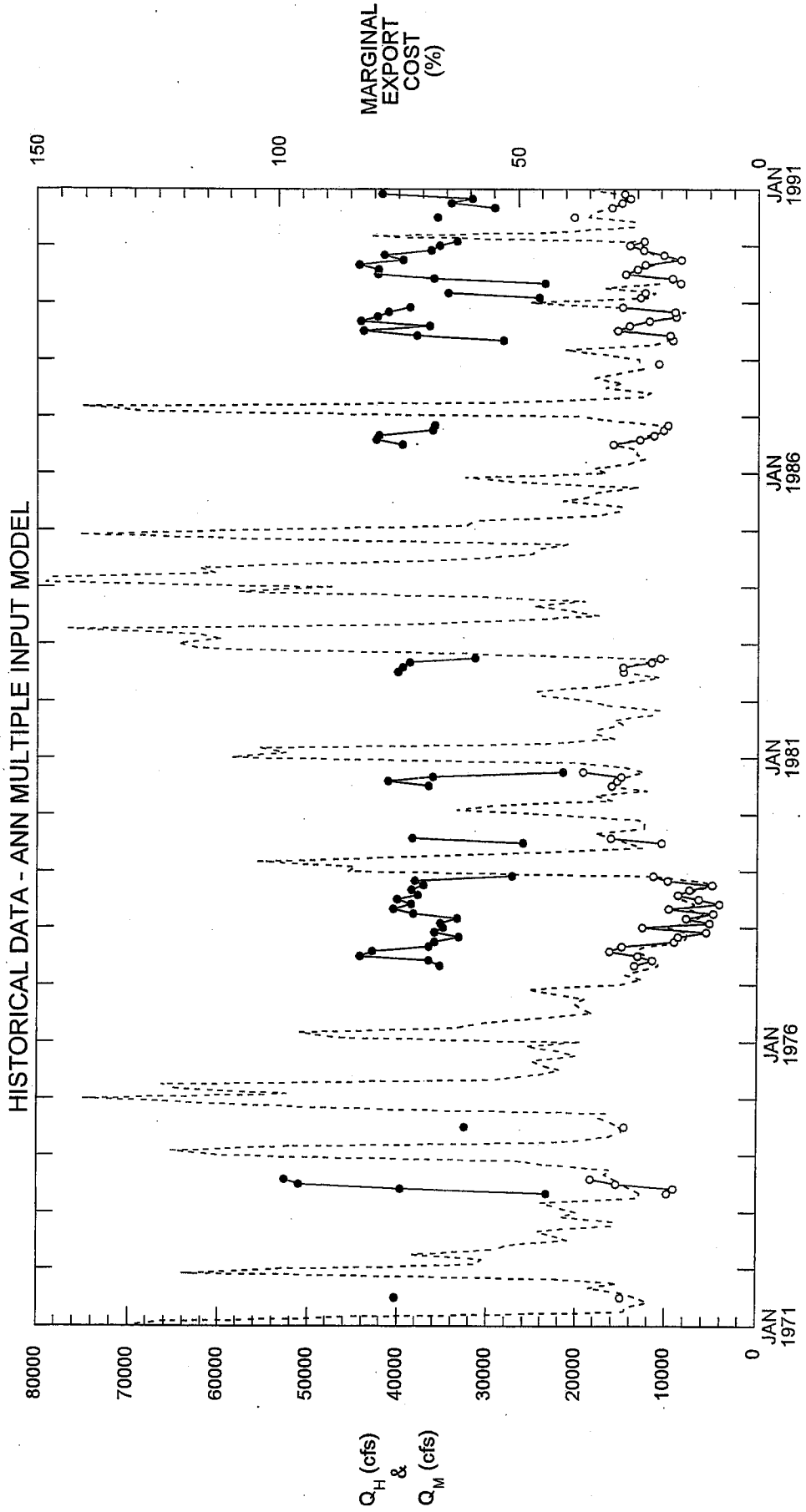

(Q_H) : HISTORICAL SAC
 (Q_M) : MODEL CALCULATED SAC
 MARGINAL EXPORT COST

INCREASE in SWP: 500 cfs, INCREASE in CVP: 500 cfs
 PITTSBURG > 6000 EC

Figure 1-115
TIME SERIES PLOT
TRANSIENT IMPULSE MARGINAL EXPORT COST
AT CLIFTON COURT FOREBAY

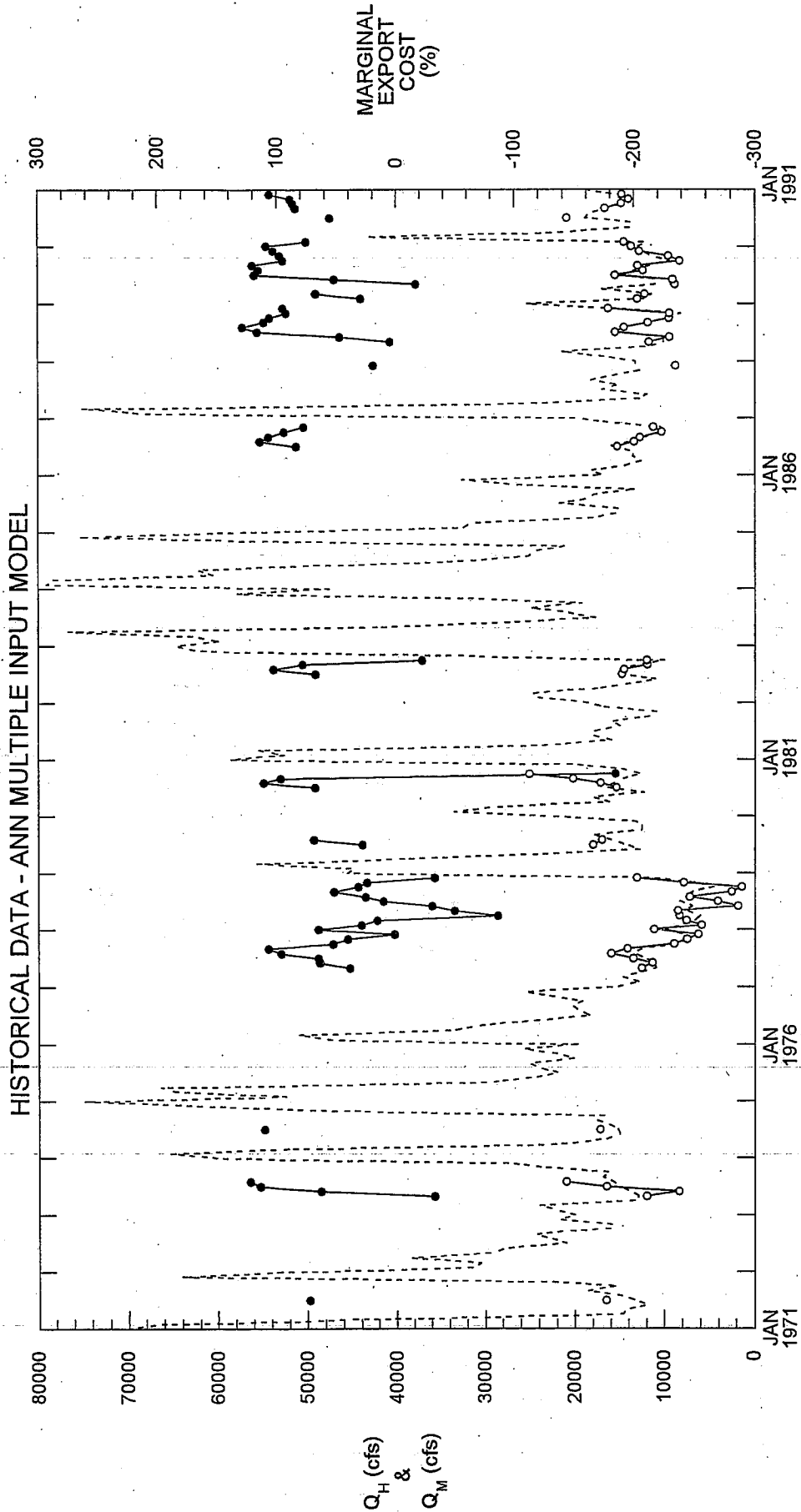

INCREASE in SWP: 500 cfs, INCREASE in CVP: 500 cfs
 PITTSBURG > 6000 EC

--- (Q_H): HISTORICAL SAC
 --- (Q_M): MODEL CALCULATED SAC
 --- MARGINAL EXPORT COST

Figure 1-116
**TRANSIENT IMPULSE MARGINAL EXPORT COST
 AT PITTSBURG**

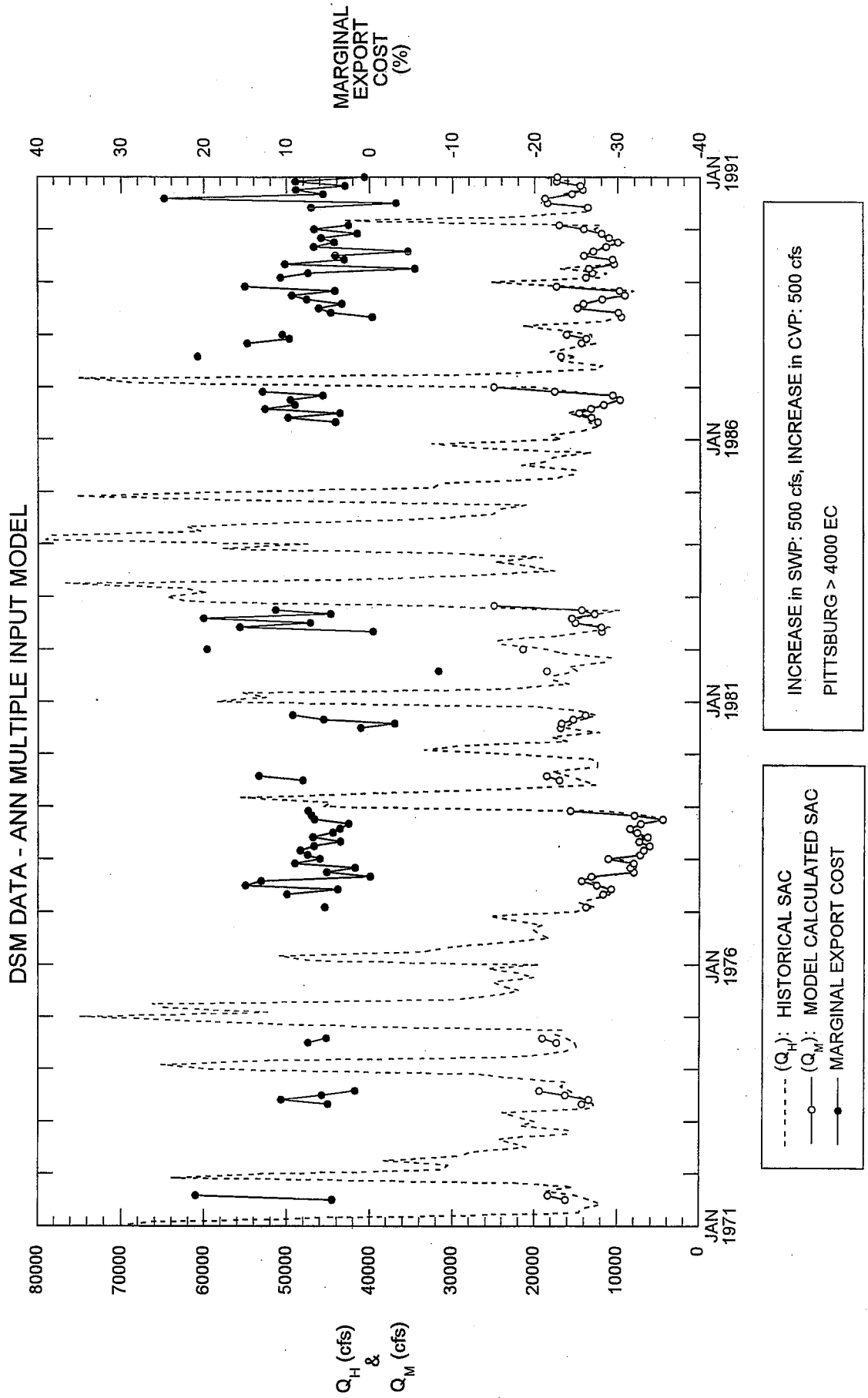
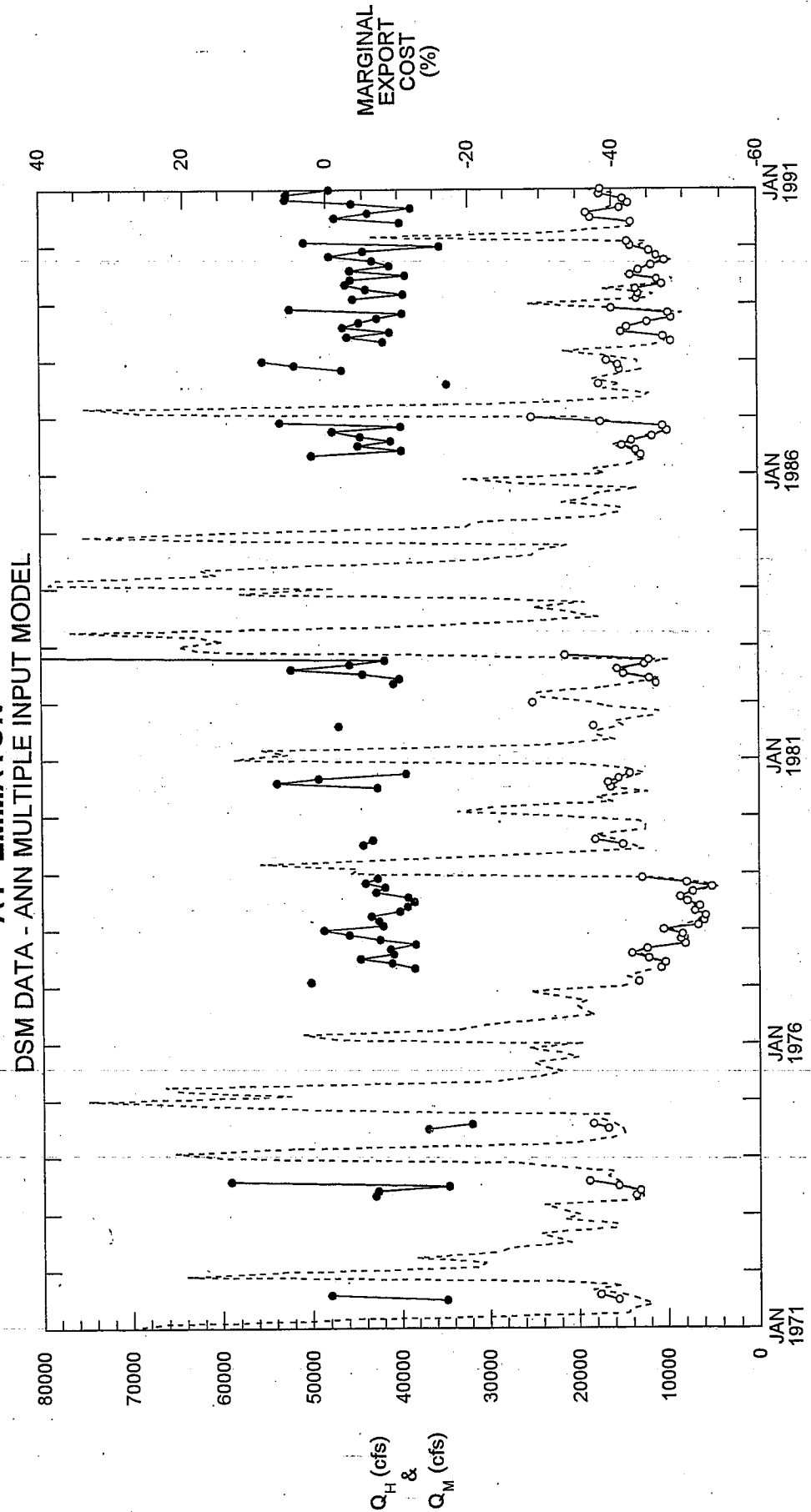

Figure 1-117
**TRANSIENT IMPULSE MARGINAL EXPORT COST
 AT EMMATON**
 DSM DATA - ANN MULTIPLE INPUT MODEL



---(Q_H): HISTORICAL SAC
 ---(Q_M): MODEL CALCULATED SAC
 --- MARGINAL EXPORT COST

INCREASE in SWP: 500 cfs, INCREASE in CVP: 500 cfs
 PITTSBURG > 4000 EC

Figure 1-118

TRANSIENT IMPULSE MARGINAL EXPORT COST AT JERSEY POINT

DSM DATA - ANN MULTIPLE INPUT MODEL

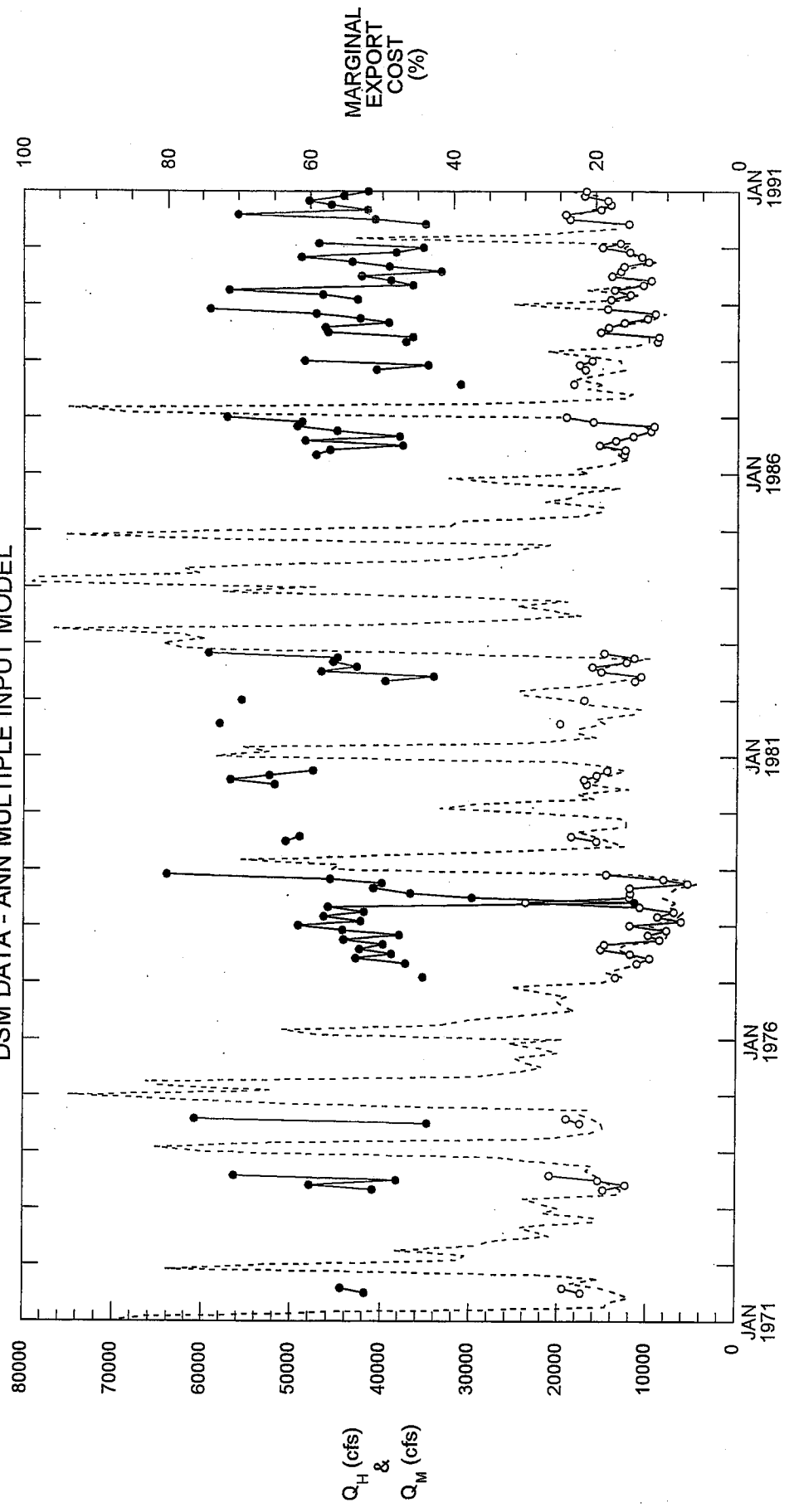

--- (Q_H): HISTORICAL SAC
— (Q_M): MODEL CALCULATED SAC
— MARGINAL EXPORT COST

INCREASE in SWP: 500 cfs, INCREASE in CVP: 500 cfs
PITTSBURG > 4000 EC

Figure 1-119
TIME SERIES PLOT
TRANSIENT IMPULSE MARGINAL EXPORT COST
AT CONTRA COSTA CANAL
 DSM DATA - ANN MULTIPLE INPUT MODEL

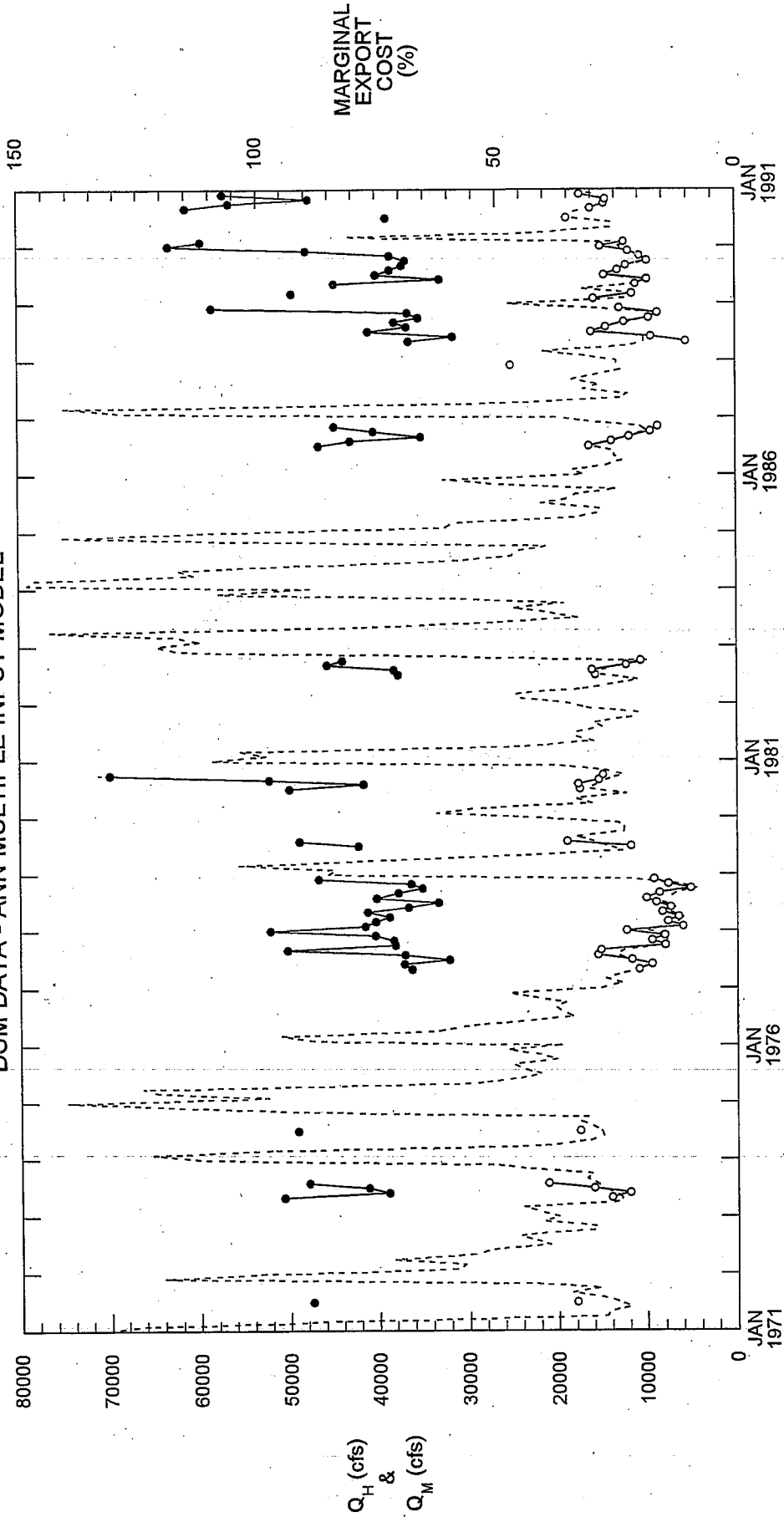

INCREASE in SWP: 500 cfs, INCREASE in CVP: 500 cfs
 PITTSBURG > 6000 EC

(Q_H): HISTORICAL SAC
 (Q_M): MODEL CALCULATED SAC
 MARGINAL EXPORT COST

Figure 1-120

**TIME SERIES PLOT
TRANSIENT IMPULSE MARGINAL EXPORT COST
AT CLIFTON COURT FOREBAY
DSM DATA - ANN MULTIPLE INPUT MODEL**

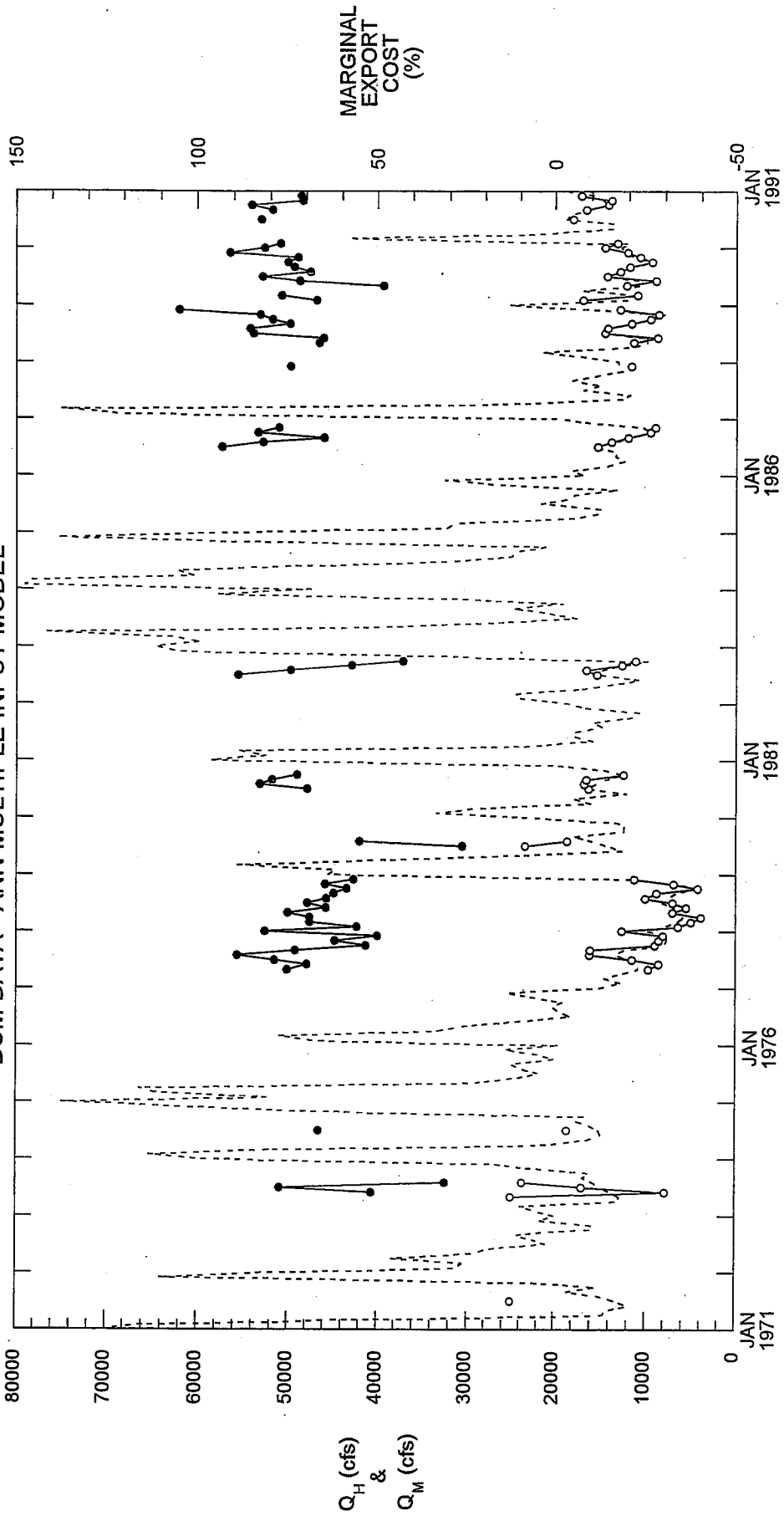

--- (Q_H): HISTORICAL SAC
—○— (Q_M): MODEL CALCULATED SAC
—●— MARGINAL EXPORT COST

INCREASE in SWP: 500 cfs, INCREASE in CVP: 500 cfs
PITTSBURG > 6000 EC

Figure 2-1. Pittsburg EC
(ANN trained with DSM2 output, historic flows and DXC position)

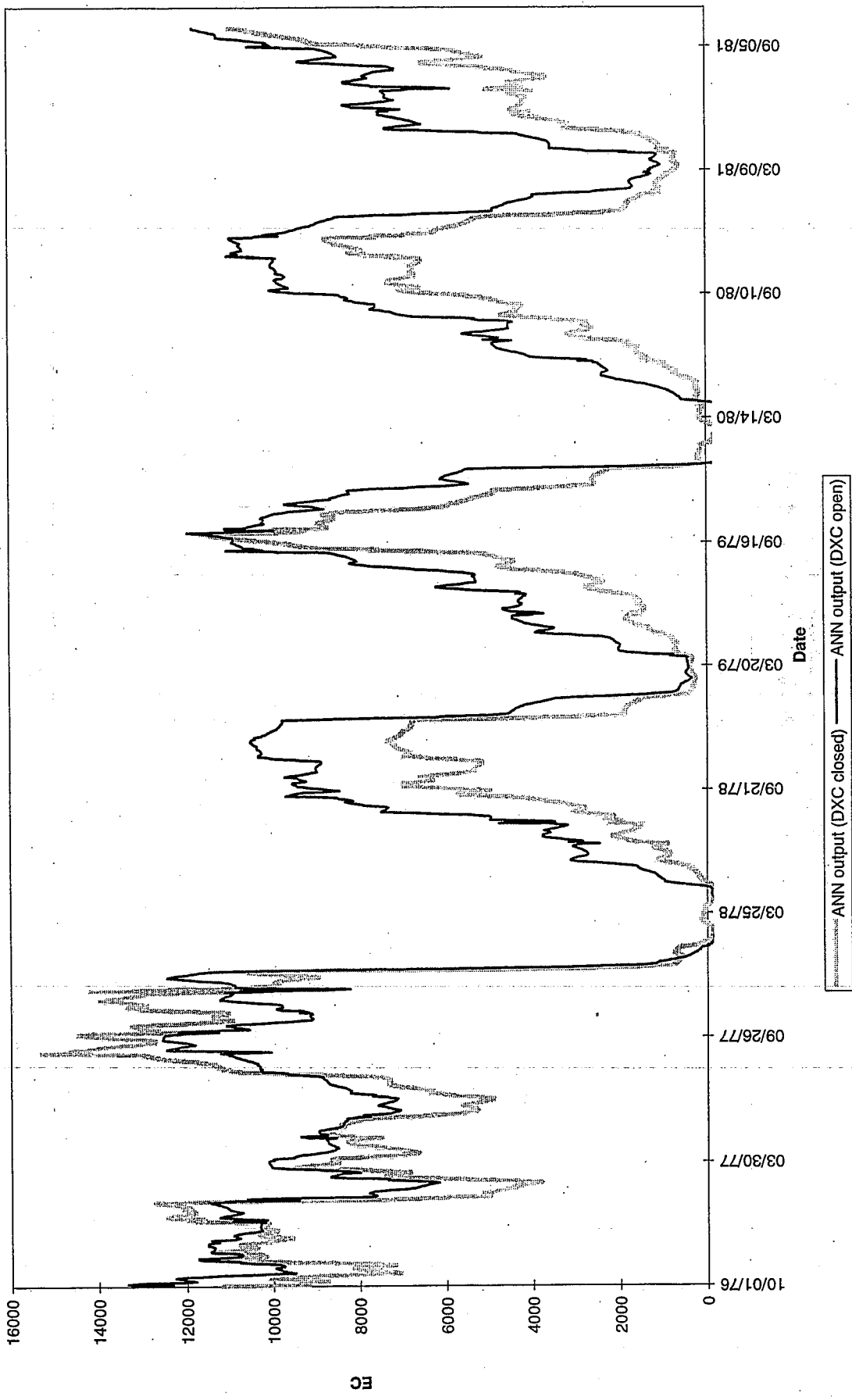

Figure 2-2. Contra Costa Canal
EC (ANN trained with DSM2 output, historic flows and DXC position)

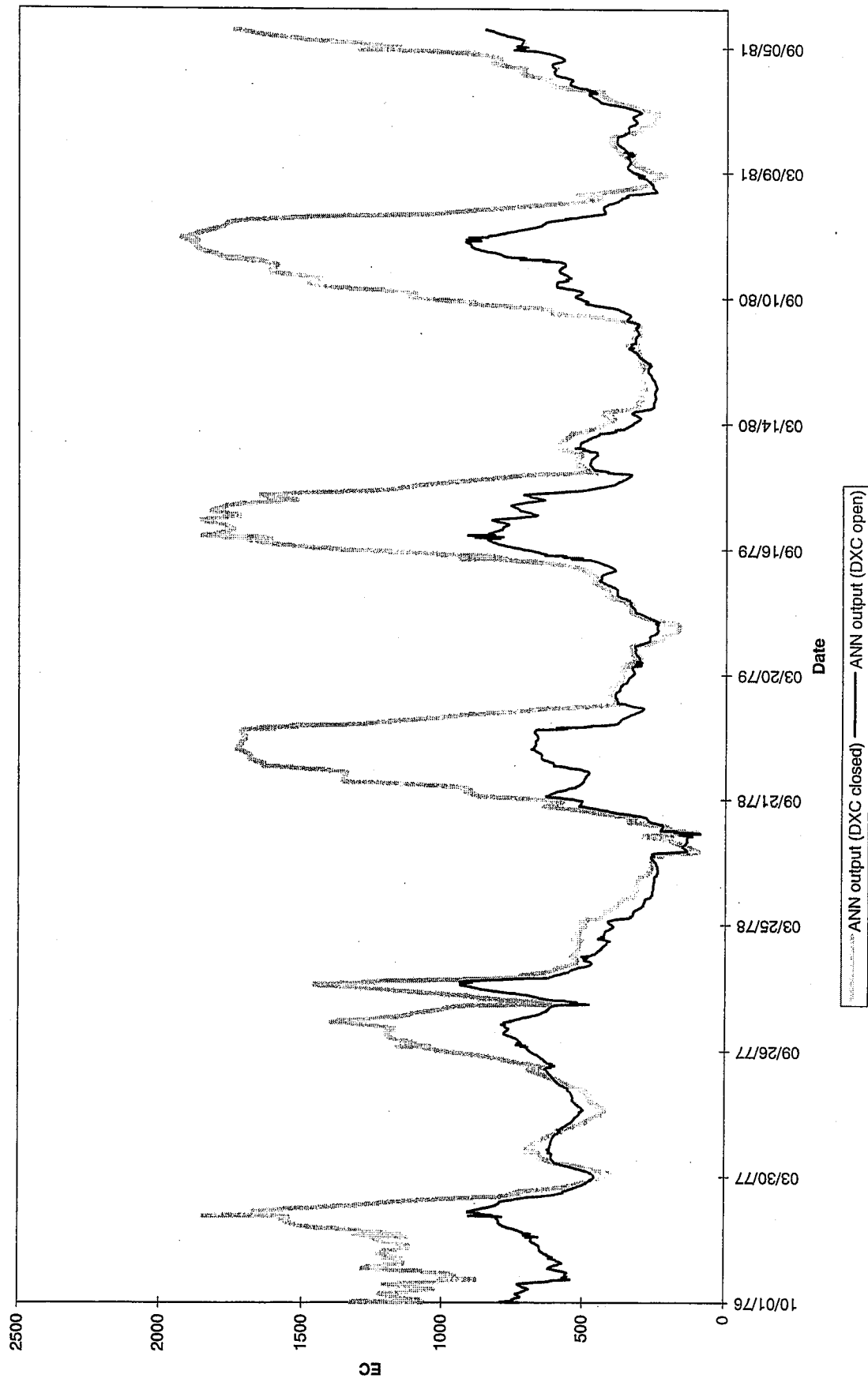

Figure 2-3. Pittsburg EC
(ANN trained with augmented training set consisting of DSM2 output, historic flows, and DXC position for base case + inverted DXC case)

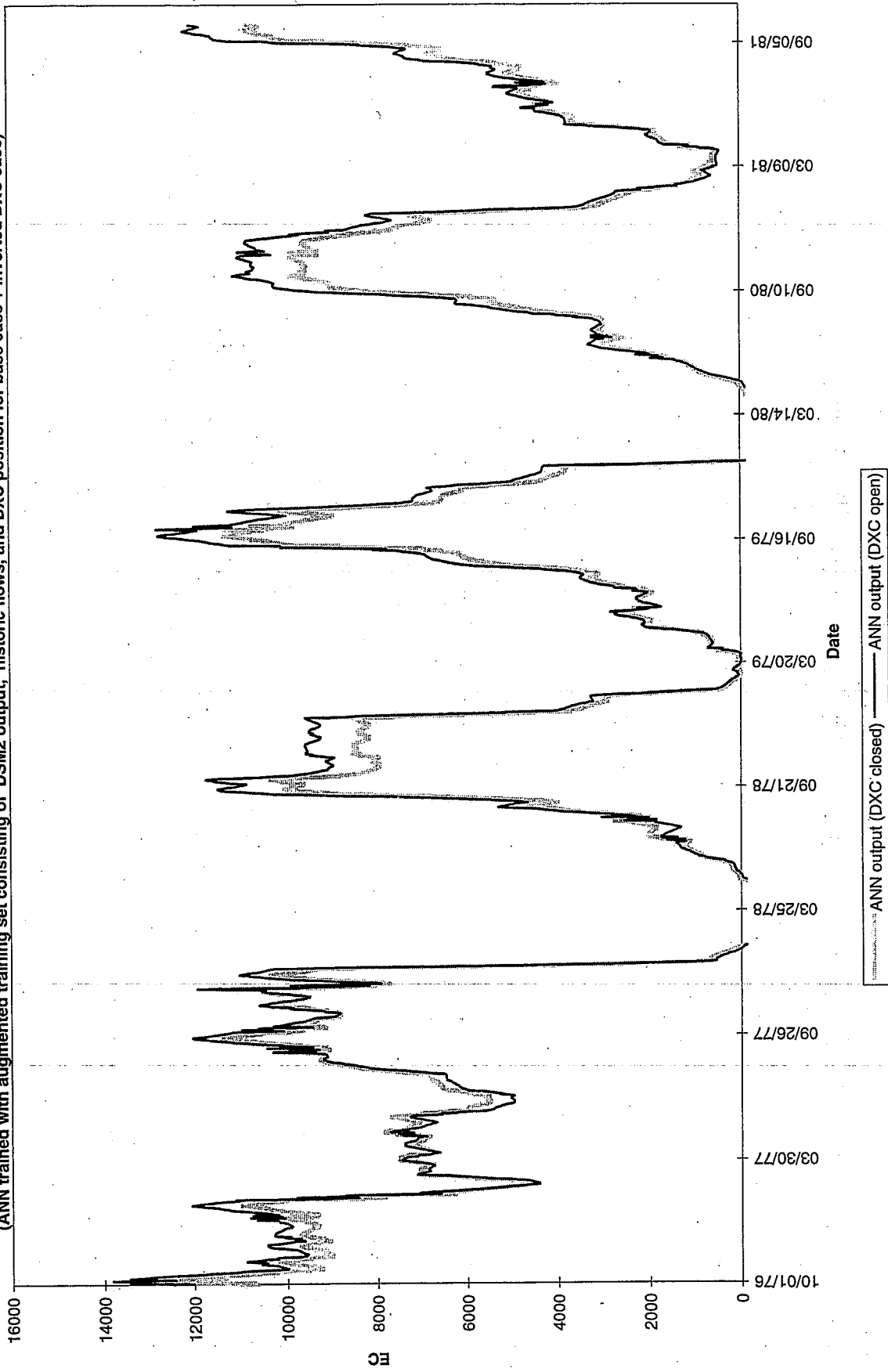

Figure 2-4. Contra Costa Canal EC
(ANN trained with augmented training set consisting of DSM2 output, historic flows, and DXC position for base case + inverted DXC case)

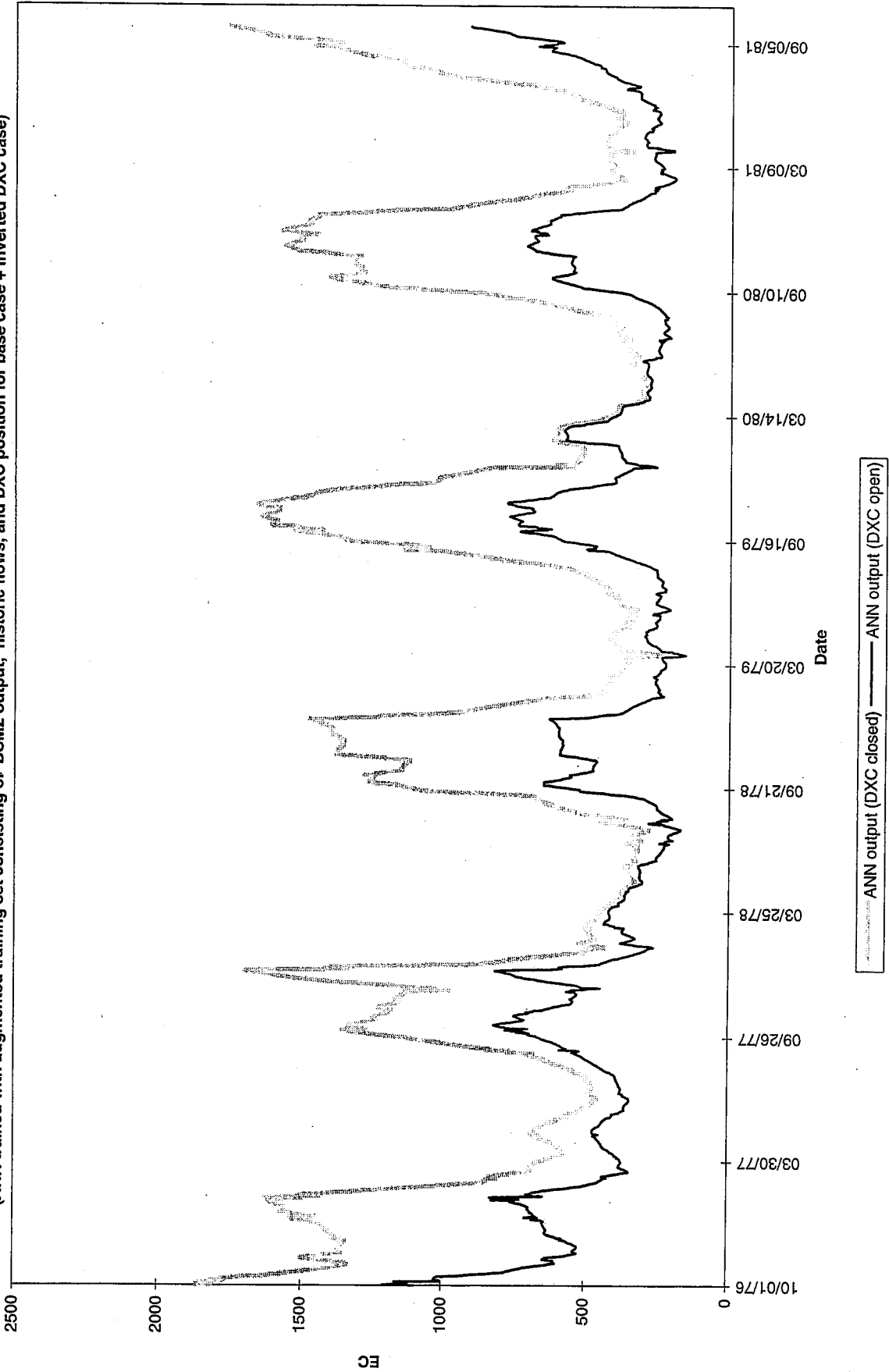

Figure 2-5. Pittsburg EC
ANN (trained with augmented training set) vs DSM2

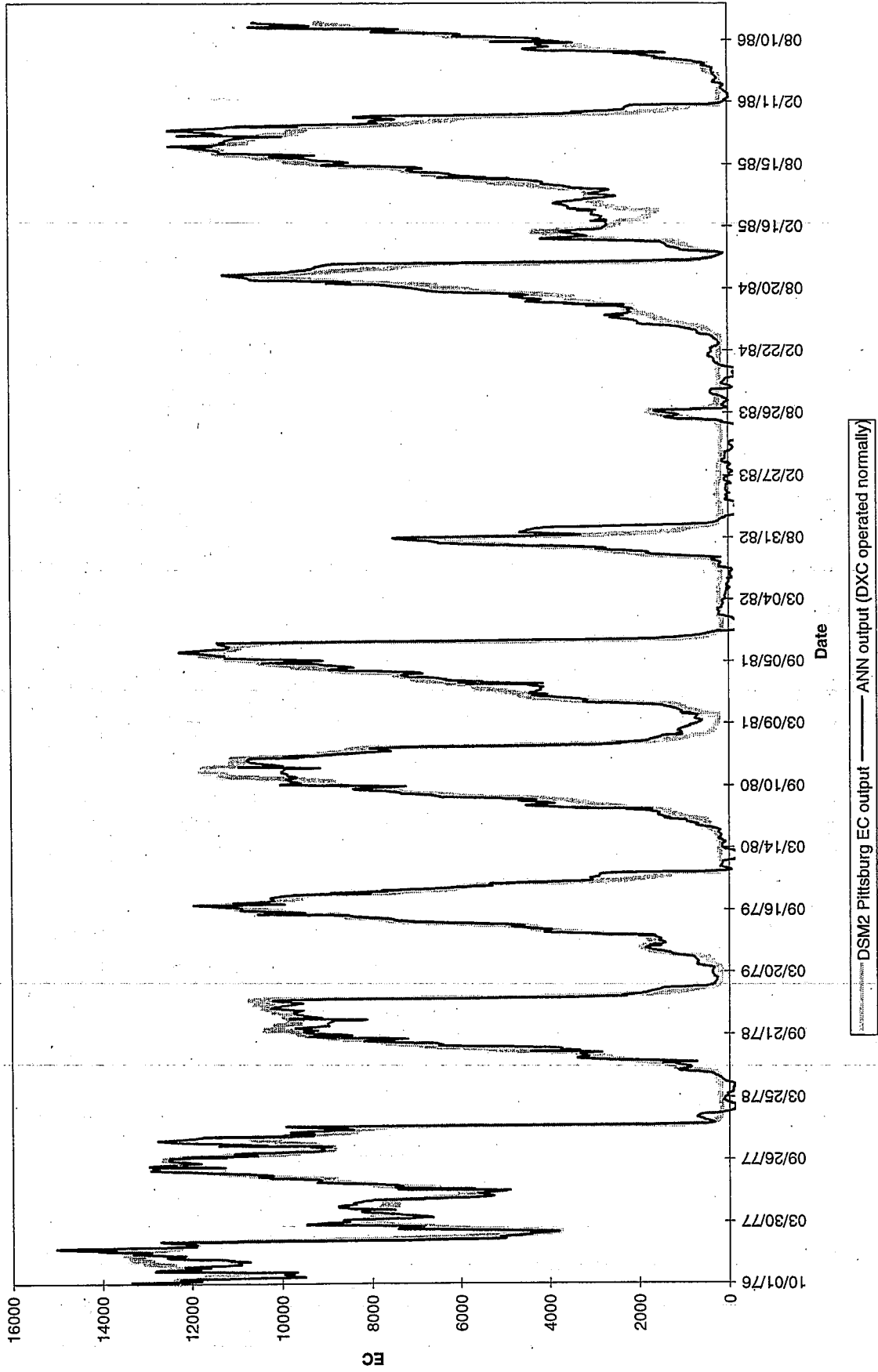

Figure 2-6. Contra Costa Canal EC
ANN(trained with augmented training set) vs DSM2

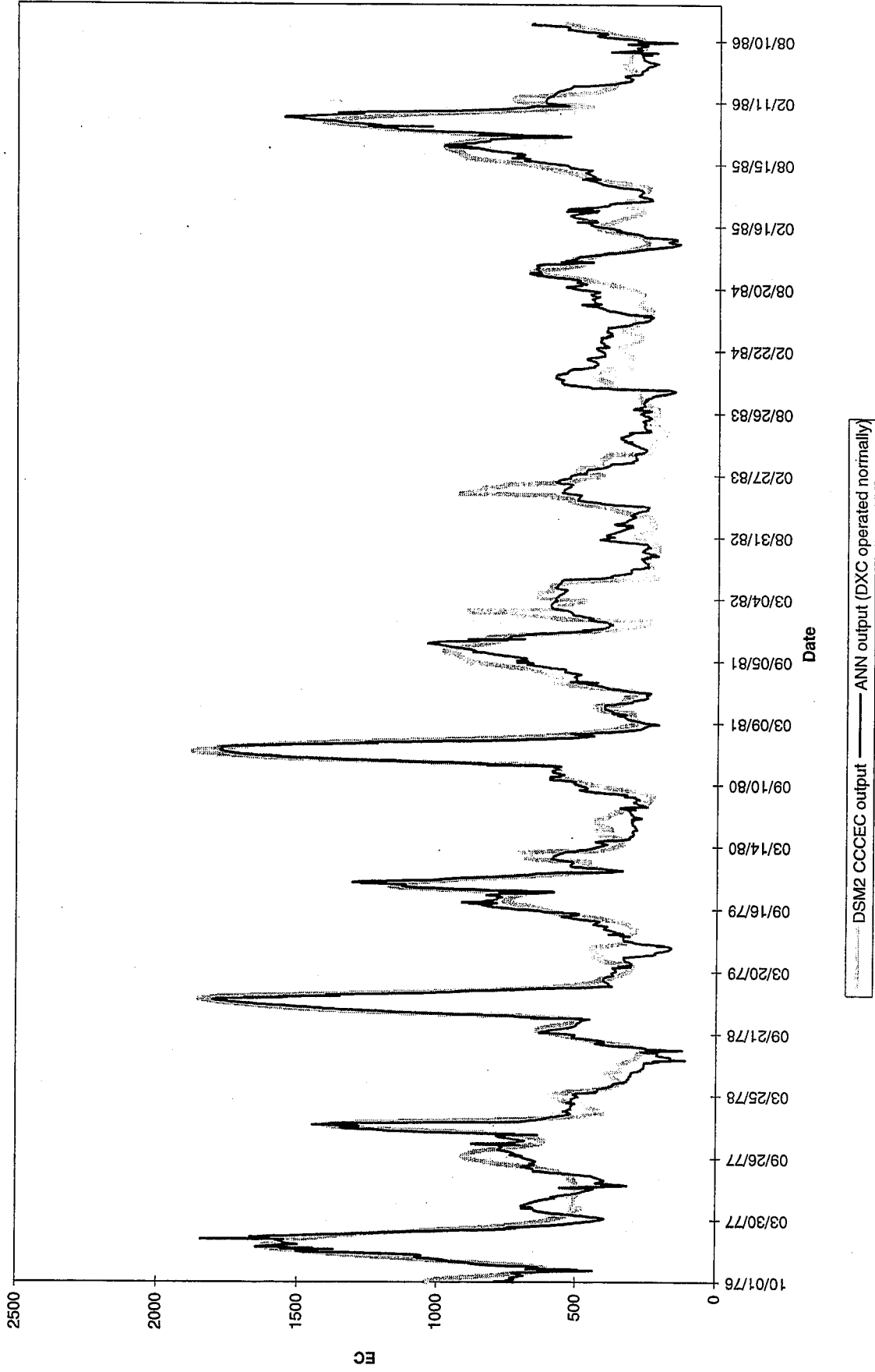
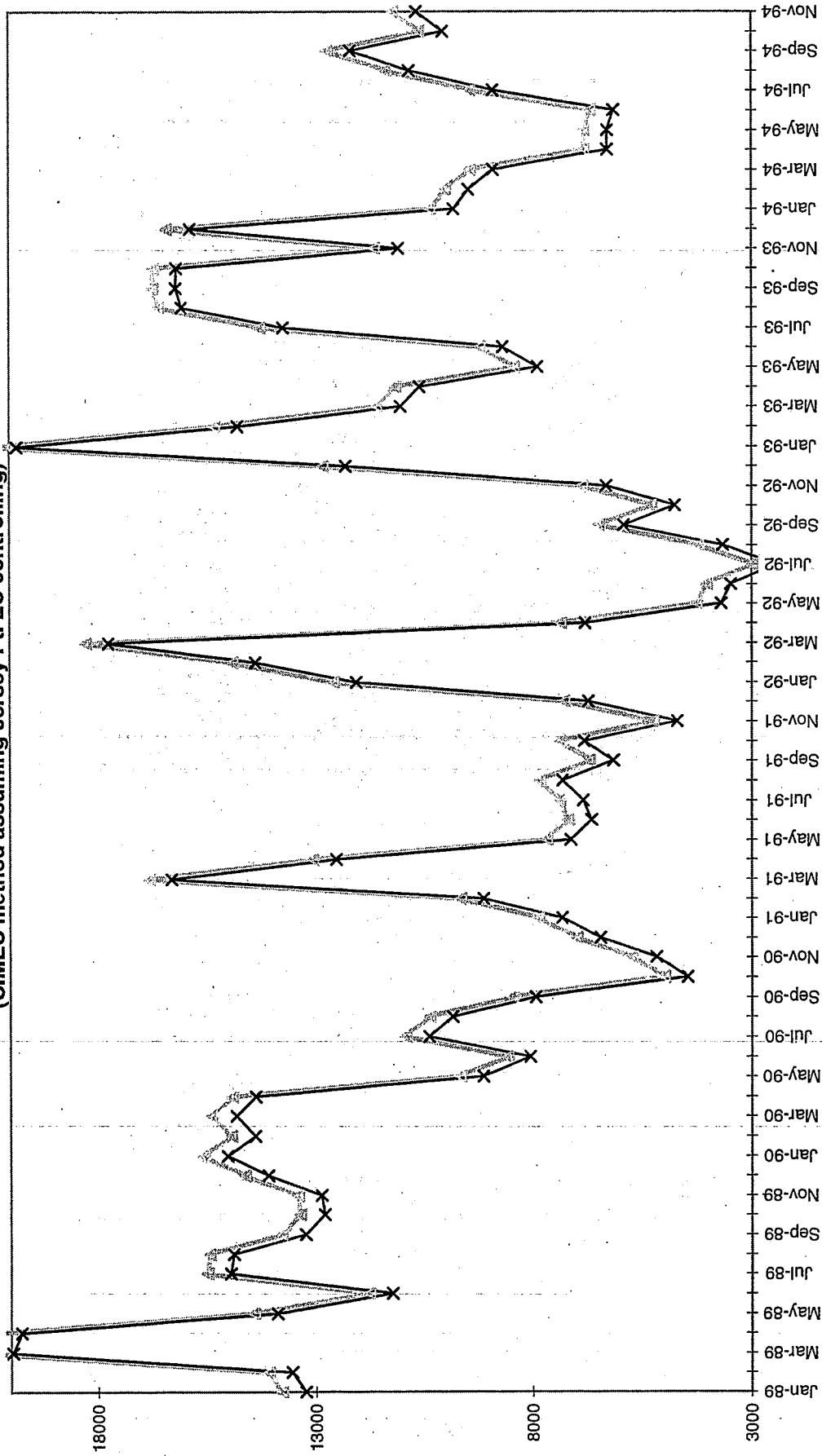

Figure 3-1. Estimated SAC with historic exports vs Estimated SAC when historic exports reduced by 500 cfs (CIMEC method assuming Jersey Pt. EC controlling)



Estimated SAC (cfs) for historic conditions — x — Estimated SAC for 500 cfs reduction in exports

Figure 3-2. Monthly carriage water estimate for a 500cfs reduction in exports (CIMEC method with Jersey Pt. EC controlling)

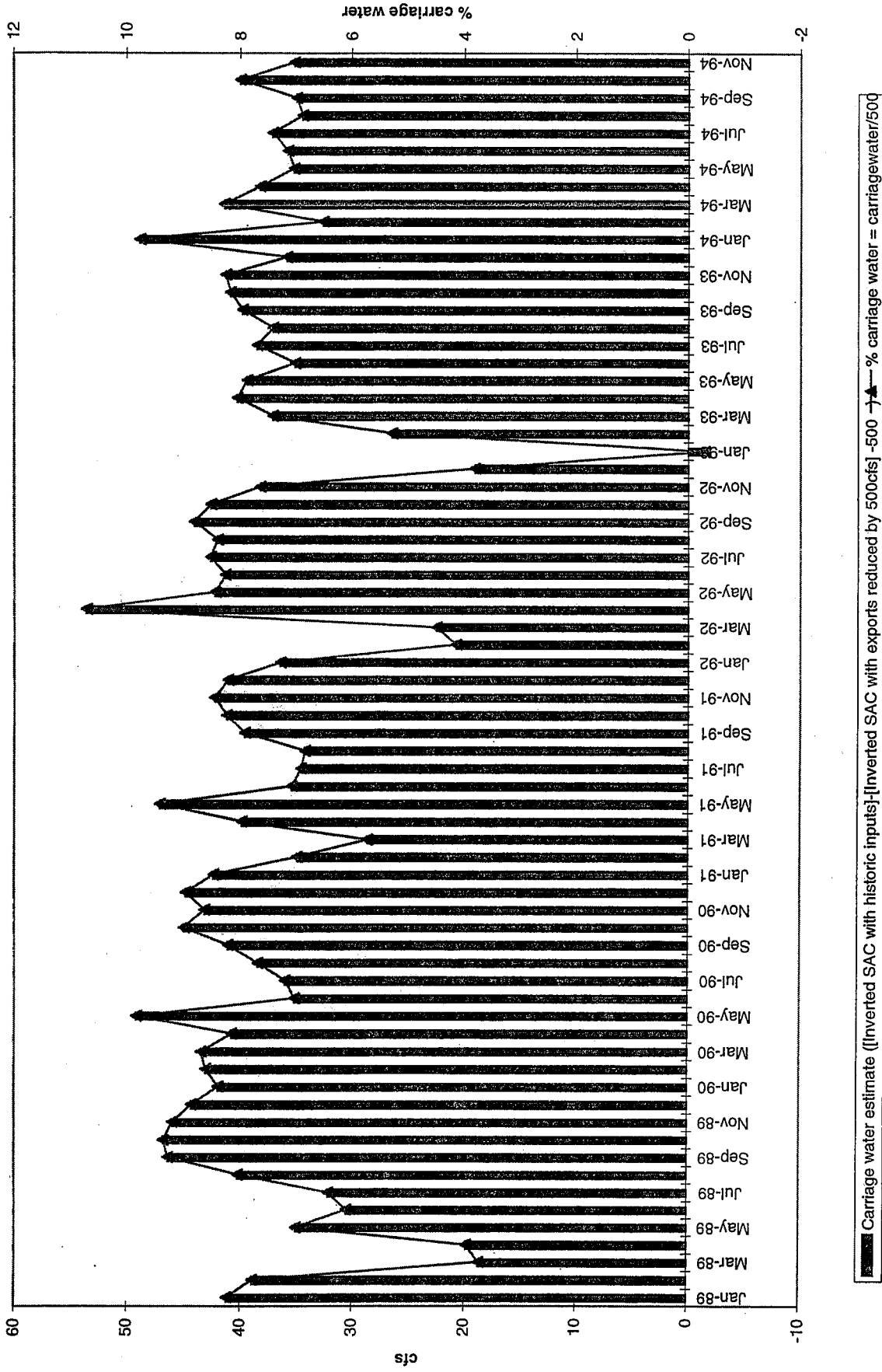
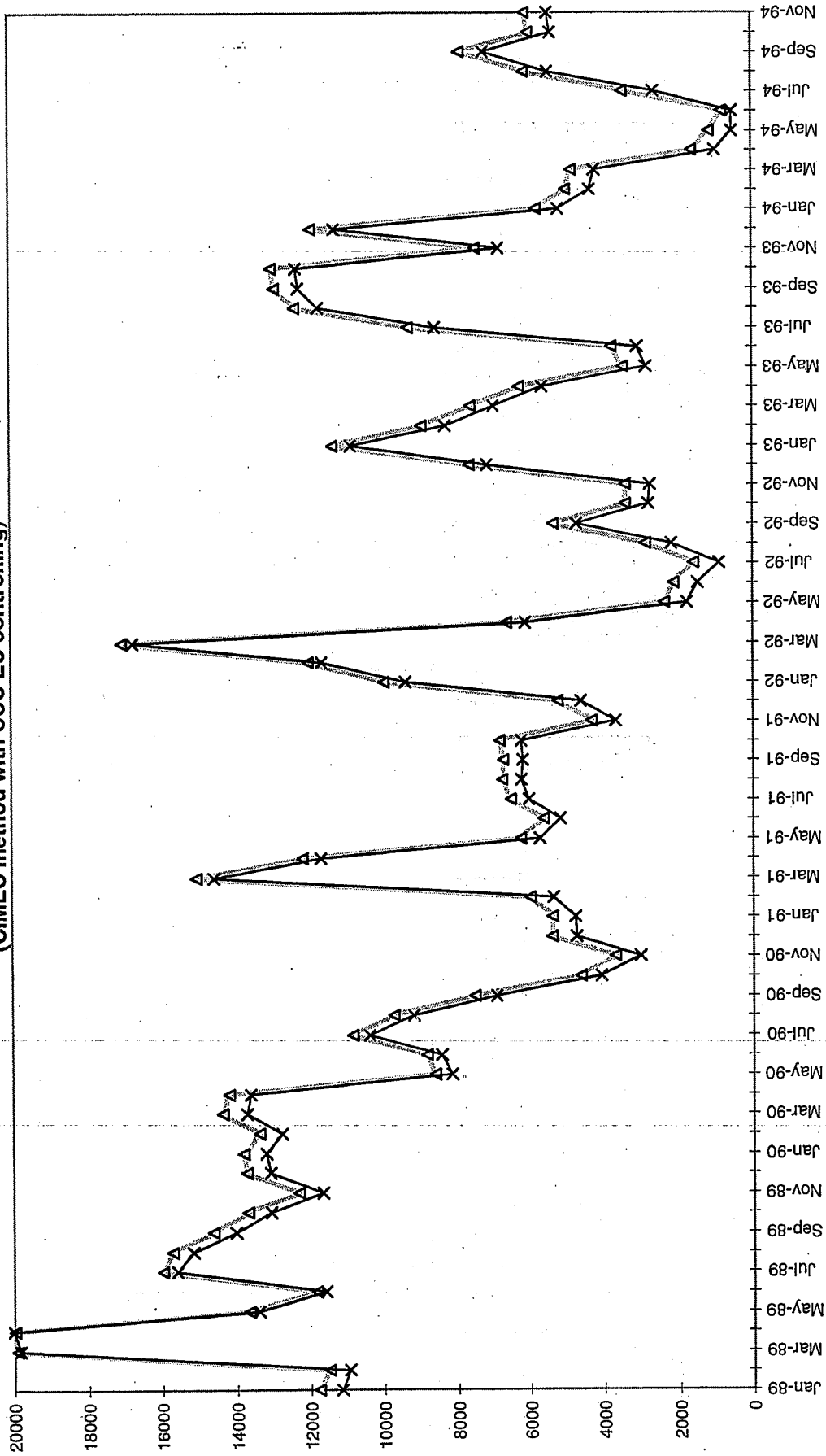

Figure 3-3. Estimated SAC with historic exports vs Estimated SAC when historic exports reduced by 500 cfs (CIMEC method with CCC EC controlling)



Estimated SAC (cfs) for historic conditions —△— Estimated SAC for 500 cfs reduction in exports

DSM2 trained ANN using CVP, DXCposition, SAC, SJR, and SWP as inputs

Figure 3-4. Monthly carriage water estimate for a 500cfs reduction in exports (CIMEC method with CCC EC controlling)

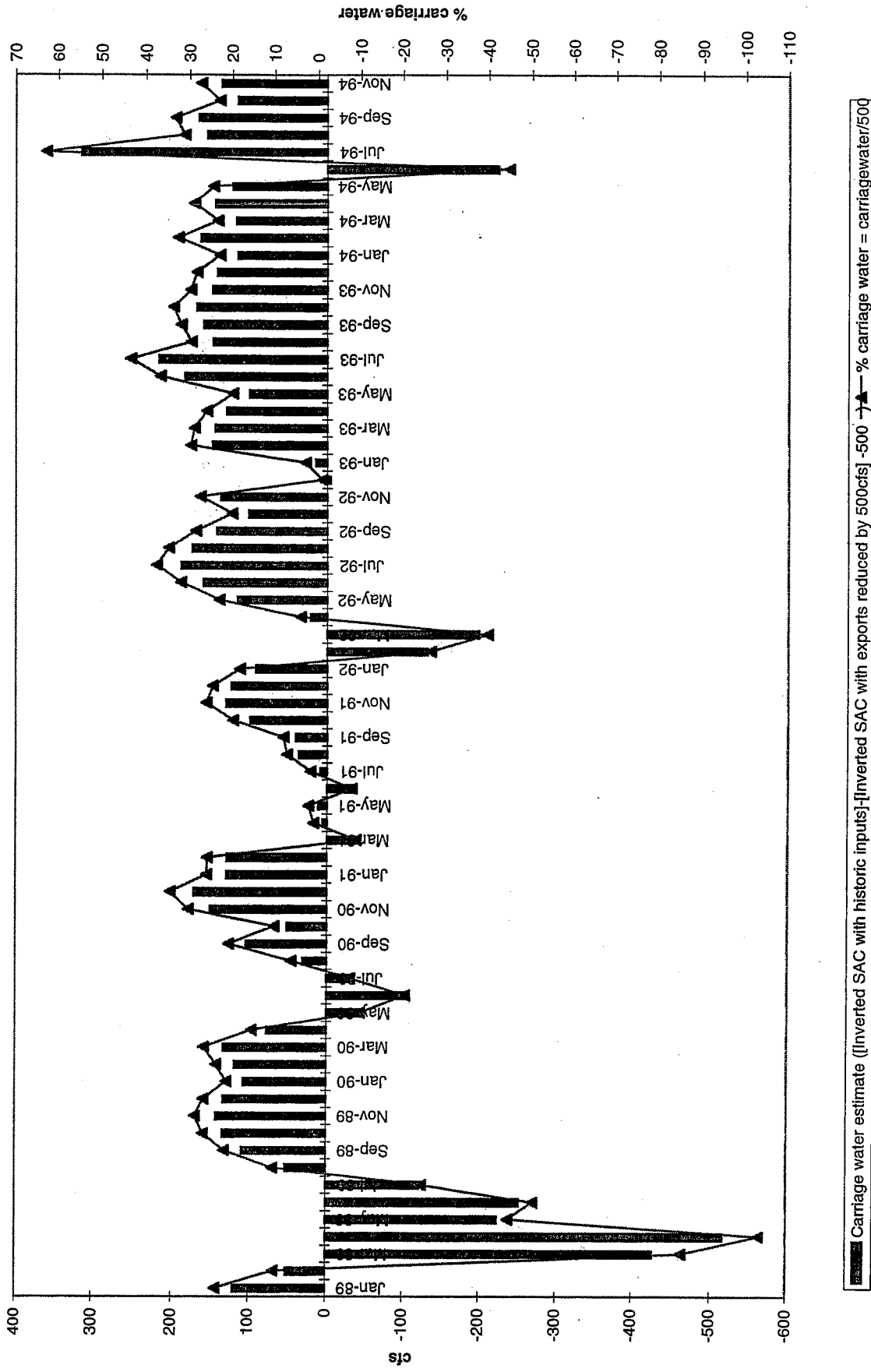
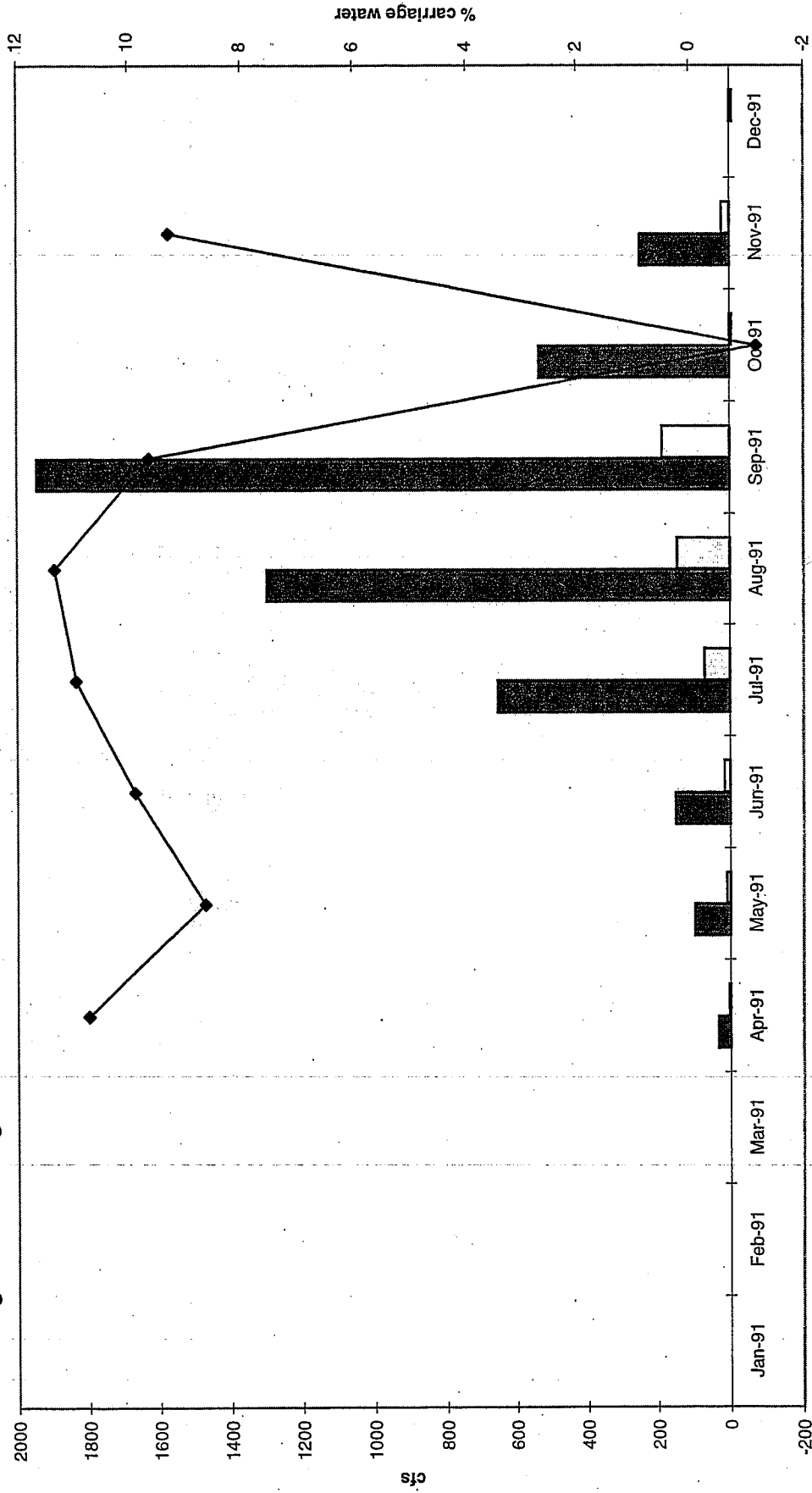

Figure 3-5. Carriage water estimate for 1991 DWB pumping (CIMEC method with Jersey Pt. EC controlling)



Drought Water Bank Pumping
 Carriage water estimate ([Inverted SAC with historic inputs(cfs)]-[Inverted SAC with exports reduced by DWB pumping(cfs)] - [DWB pumping(cfs)])
 % Carriage Water = Carriage Water/(1991 Drought Water Bank Pumping)

Figure 3-6. Carriage water estimate for 1991 DWB pumping (CIMEC method with CCC EC controlling)

